



see what Delta can do™

**COMMERCIAL
CATALOG &
PRICE BOOK
2016 | 2017
EFFECTIVE: 05.01.16**





We're saving water, one faucet at a time.

For years, we have partnered with the EPA WaterSense® Program to protect and conserve our nation's water supply. Named as the EPA's Manufacturer Partner of the Year in 2011, 2013 and 2014, we are now proud to be a WaterSense Sustained Excellence Award Winner in 2015.

Currently, over 80% of Delta® bath suites feature showerheads and handshowers that meet WaterSense requirements, using 20–40% less water than the industry standard.* Our WaterSense-labeled lavatories use 32% less* water, while performing as well or better than their less-efficient counterparts. And many of our products meet California's stringent Title 20 water-efficiency standards.

Delta products also offer sustainability in the form of long-lasting durability—thanks to smart solutions like DIAMOND™ Seal Technology—as well as contributing to LEED® certification.

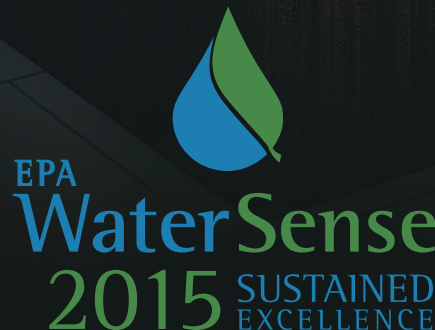

How to use this catalog.

Look for these icons throughout the catalog to easily identify key features of our commercial products.



= Proximity® Sensing Technology



= H₂Optics® Sensing Technology



= DIAMOND™ Valve



= H₂Okinetic® Technology



= MagnaTite® Docking



= WaterSense® Labeled Product



= Water-Efficient Product

Kitchen Faucets: flow rate of 1.5 or 1.8 gpm versus Industry Standard ASME A112.18.1/CSA B125.1 of 2.2 gpm.

Lavatory Faucets: flow rate of 1.5 gpm versus Industry Standard ASME A112.18.1/CSA B125.1 of 2.2 gpm.

Flush Valves: water closet flush valves of 1.27 gpf and urinal flush valves of .5 gpf versus Industry Standard ASME 112.2.

Showerheads and Handshowers: flow rate of 1.5 or 2.0 gpm versus Industry Standard ASME A112.18.1/CSA B125.1 of 2.5 gpm.



= ADA-Compliant Product

Delta faucets are compliant with all federal and state drinking water legislation.

*Based on flow rate for showerheads and handshowers of 1.5 gpm or 2.0 gpm versus Industry Standard ASME A112.18.1/CSA B125.1 of 2.5 gpm; and flow rate for lavatory faucets of 1.5 gpm versus Industry Standard ASME A112.18.1/CSA B125.1 of 2.2 gpm.

WaterSense® is a registered trademark of the U.S. Environmental Protection Agency.

TECHNOLOGICAL INNOVATIONS 4

LAVATORY FAUCETS

Electronic Lavatory Faucets with Proximity® Sensing Technology	8
H ₂ Optics®/Thermal/DEMD Electronic Lavatory Faucets	10
DEMD Electronic	12
Single-Handle	13
Two-Handle	14
Metering	16

FLUSH VALVES

Electronic	18
Specialty/Manual	20

HEALTHCARE

Surgeon Scrub Up	24
General Surgeon Scrub Up	25
Low-Profile Institutional Products	26
Bedpan Cleansers	26
Laboratory	27

UNIVERSAL DESIGN

Décor Assist™	30
Bath Safety	32
Single-Handle General Sink Faucets	34
Two-Handle General Sink Faucets	36
Wall Mount General Sink Faucets	38

SHOWERING SOLUTIONS

MultiChoice® Universal	40
Tub & Showers	42
In2ition® Showers	44
Showerheads	44
Handshowers	46

BATH ACCESSORIES/DRAINAGE 48

PRICE BOOK 50

WARRANTY C174

WEB C175



TECHNOLOGIES THAT MAKE A DIFFERENCE

H2Optics® Sensing Technology.

Delta® electronic faucets and flush valves with H2Optics Sensing Technology operate consistently, overcoming such factors as dark clothing or lighting conditions. They're also water efficient*, contributing to LEED® certification.

Battery backup for hardwire- operated electronics.

Battery backup lets hardwire units keep working through power outages, by temporarily switching to a 9-Volt battery. Available on most Delta hardwire-operated electronic models.

*Water-Efficient Product—Lavatory faucets: flow rate of 1.5 gpm versus Industry Standard ASME A112.18.1/CSA B125.1 of 2.2 gpm.
Flush valves: water closet flush valves of 1.27 gpf and urinal flush valves of .5 gpf versus Industry Standard ASME 112.2.



DIAMOND™ Valve.

By reducing buildup of calcium and mineral deposits, our durable DIAMOND Valve eliminates wear on seals, reducing leaks and helping faucets last longer.

Proximity® Sensing Technology.

Proximity Sensing Technology—the next generation in hands-free functionality—makes Delta electronic faucets the most responsive in the industry. The entire faucet body acts as a sensor, activating water flow when approached and stopping once hands are removed. And the lack of an exposed sensor reduces the risk of sensor damage from vandalism or cleaning products.





H2Okinetic[®] Technology.

H2Okinetic Technology sculpts water into a unique, oscillating wave pattern that delivers more warmth, more intensity, and 3X the coverage* of a standard shower. Users get the feeling of more water, without using more water—helping you save on utility costs, and contributing points toward LEED[®] certification.

*Coverage measured in accordance with EPA WaterSense[®] Specification for Showerheads, March 4, 2010.

In2ition® Two-in-One Shower.

Our In2ition Two-in-One Shower offers two streams of water at once, so users can put water where they need it most—using the integrated showerheads together or separately. In its primary position, the In2ition Shower functions as a regular showerhead, while the handshower offers the flexibility for closer-range tasks.



MultiChoice® Universal Rough-in.

Installing the Delta® MultiChoice Universal Rough-in at any time makes it easier to upgrade style and functionality later, without changing plumbing behind the wall. Multiple connection options and a high-flow rough for shower-only configurations add even more flexibility, while a refined temperature limit stop allows more precise settings.





Single-Hole Single-Inlet Gooseneck Faucet with Proximity Sensing Technology
620TP3320



- 24 VAC to 6 VDC
- Hardwire operation
- 1.5 gpm vandal-resistant laminar outlet
- Surface-mounted control box
- Field adjustment of electrical sensitivity
- Models also available with additional outlets, 10" recessed boxes and Brilliance® Stainless finish
- Optional 4" or 8" coverplate
- Transformer required—order separately
- Available as battery-operated model



Single-Hole Single-Inlet Faucet with Proximity Sensing Technology
630TP320



- 24 VAC to 6 VDC
- Hardwire operation
- Cast brass body
- 1.5 gpm vandal-resistant laminar outlet
- Surface-mounted control box
- Field adjustment of electrical sensitivity
- Easy-to-program controller provides metering mode and line rinse
- Optional 4" cast coverplate
- Transformer required—order separately
- Available as battery-operated model



Single-Hole Single-Inlet Faucet with Proximity Sensing Technology
600T040



- 24 VAC to 6 VDC
- Hardwire operation
- Cast brass body
- 1.5 gpm vandal-resistant laminar outlet
- Surface-mounted control box
- Field adjustment of electrical sensitivity
- Models also available with additional outlets and Brilliance® Stainless finish
- Optional 4" or 8" decorative coverplate
- Transformer required—order separately
- Available as battery-operated model



Single-Hole Single-Inlet High-Rise Faucet with Proximity Sensing Technology
590TP0120



- 24 VAC to 6 VDC
- Hardwire operation
- Cast brass body
- 1.5 gpm vandal-resistant laminar with Agion® antimicrobial outlet
- Surface-mounted control box
- Field adjustment of electrical sensitivity
- Models also available with 8" and 4" coverplates, additional outlets and 10" recessed boxes
- Transformer required—order separately
- Available as battery-operated model



3-Hole Single-Inlet 4" Centerset Faucet with Proximity Sensing Technology
591TP0250



- 24 VAC to 6 VDC
- Hardwire operation
- Cast brass body
- 0.5 gpm vandal-resistant laminar outlet
- Surface-mounted control box
- Field adjustment of electrical sensitivity
- Models also available with additional outlets and 10" recessed boxes
- Transformer required—order separately
- Available as battery-operated model



Single-Hole Single-Inlet Faucet with Proximity Sensing Technology
590-PLGHDFHW



- 24 VAC to 6 VDC
- Hardwire operation
- Metal construction
- 0.5 gpm vandal-resistant laminar outlet
- Surface-mounted control box
- Field adjustment of electrical sensitivity
- Models also available with 4" and 8" coverplates
- Transformer required—order separately
- Available as battery-operated model

All models featured are also available with the battery backup option referenced on page 4.

For additional information on the models shown here, as well as other available models, please go to www.specselect.com.

Responsive and Efficient

With a response time of four pulses per second, H₂Optics® Technology balances reaction time and battery conservation.



590T1120



Single-Hole Single-Inlet High-Rise Faucet with H2Optics Technology 590T1120



- Cast brass body
- Battery operation
- 1.5 gpm vandal-resistant laminar with Agion® antimicrobial outlet
- 10" recessed boxes
- Adjustable sensing range and maximum run time
- Models also available with hardwire operation and additional outlets



3-Hole Single-Inlet 4" Centerset Faucet with H2Optics Technology 591T1220



- Cast brass body
- Battery operation
- 1.5 gpm vandal-resistant laminar with Agion® antimicrobial outlet
- 10" recessed boxes
- Adjustable sensing range and maximum run time
- Models also available with hardwire operation, additional outlets and mixing valves



Single-Hole Single-Inlet Faucet with H2Optics Technology 590LF-LGHGMHDF



- Battery operation
- Metal construction
- 0.5 gpm vandal-resistant laminar outlet
- No external adjustments required
- Model with escutcheon: 591LF-LGHGMHDF



Single-Hole Faucet with ASSE 1070 Thermostatic Mixing Valve DEMD-611LF



- Battery operation
- Above-deck solenoid and below-deck battery
- Integrated above-deck thermostatic mixing valve
- 0.66 gpm with vandal-resistant wrench flat spray outlet
- Temperature adjustment handle
- .17 gallon/cycle based on 15 second maximum run time
- Standard infrared sensing
- Optional 4" coverplate
- 1.0 gpm available: DEMD-611-10LF



Single-Inlet Wall Mount Faucet DEMD-402LF - 8" spout DEMD-404LF - 6" spout



- 24 VAC to 9 VDC
- Adjustable maximum run time
- Pre-mixed water
- Hardwire operation
- Adjustable sensor range
- Standard infrared sensing
- Remote control available (060967A)
- 0.5 gpm outlet

Some hardwire models are also available with the battery backup option referenced on page 4. For additional information on the models shown here, as well as other available models, please go to www.specselect.com.



Single-Hole Faucet
DEMD-301LF



- Battery operation
- Forged brass body
- Pre-mixed water
- Adjustable maximum run time
- Adjustable sensor range
- Standard infrared sensing
- Optional 4" coverplate available
- Hardwire kit available for field conversion
- Remote control available (060967A)
- 0.5 gpm outlet with vandal-resistant wrench flat spray outlet



Single-Hole Dual-Inlet Faucet with Side Mixer
DEMD-311LF



- Battery operation
- Non-removable side mixer to adjust water temperature
- Standard infrared sensing
- Adjustable maximum run time, sensor range
- Optional 4" coverplate available
- Hardwire kit available for field conversion
- Remote control available (060967A)
- 0.5 gpm outlet with vandal-resistant wrench flat spray outlet
- Model with technician's mixer to adjust temperature: DEMD-312LF



Single-Hole Faucet
DEMD-201LF



- Battery operation
- Above deck electronics
- Pre-mixed water
- 0.5 gpm with vandal-resistant flat spray outlet
- Standard infrared sensing



Single-Hole Dual-Inlet Faucet with Side Mixer
DEMD-211LF



- Battery operation
- Above deck electronics
- 0.5 gpm with vandal-resistant flat spray outlet
- Non-removable side mixer to adjust water temperature
- Standard infrared sensing
- Model with technician's mixer to adjust temperature: DEMD-212LF



Single-Hole Faucet
DEMD-101LF



- Battery operation
- Above-deck solenoid and battery
- Pre-mixed water
- 0.5 gpm with vandal-resistant wrench flat spray outlet
- Standard infrared sensing



Single-Hole Dual-Inlet Faucet with Side Mixer
DEMD-111LF



- Battery operation
- Above-deck solenoid and battery
- Non-removable side mixer to adjust water temperature
- 0.5 gpm with vandal-resistant wrench flat spray outlet
- Standard infrared sensing
- Model with technician's mixer to adjust temperature: DEMD-112LF



Single-Hole Electronic Soap Dispenser
DESD-550 – Cast brass body
DESD-250 – Non-metal version



- Solid machined shank with low profile spout
- Standard 800 ml soap bottle
- Standard infrared sensing
- Fits on decks up to 2" thick
- LED indicators: Yellow = low battery, Red = low soap
- Battery operation
- Hardwire kit available for field conversion

Ceramic Disc Technology

Smooth operation makes this washerless faucet low-maintenance. The volume and temperature control is integrated so the faucet can be turned on in the same position as it was turned off for consistent temperature setting.



22C101



Single-Hole Faucet
22C631



- Cast brass body
- Vandal-resistant lever handle and 1.5 gpm outlet
- Ceramic cartridge with rotational limit stop to limit turning of the handle into hot zone



4" Centerset Faucet
22C131 – Less pop-up (no hole)
22C331 – With metal pop-up



- Cast brass body
- Vandal-resistant lever handle and 1.5 gpm flow control outlet
- Ceramic cartridge with rotational limit stop to limit turning of the handle into hot zone
- Model with 1.5 gpm vandal-resistant outlet: 22C101



4" Centerset Faucet
501LF-HGMHDF



- Vandal-resistant lever handle and 0.5 gpm outlet
- Adjustable handle limit stop
- DIAMOND™ Valve
- .35 gpm available: 501LF-TGMHDF



4" Centerset Faucet
515LF-HDF



- Includes metal pop-up
- Vandal-resistant 6" elbow handle and 1.5 gpm outlet
- Adjustable handle limit stop
- DIAMOND Valve



Single-Hole Faucet
570LF-WFHDF



- 4" swing spout
- Vandal-resistant lever handle and 1.5 gpm outlet
- Stainless steel ball
- Adjustable handle limit stop



Widespread Single Control Faucet
24T2643



- Vandal-resistant 6" lever handle
- 4" to 16" adjustable centers
- 1.5 gpm outlet
- Stainless steel ball

Some hardwire models are also available with the battery backup option referenced on page 4.

For additional information on the models shown here, as well as other available models, please go to www.specselect.com.



Seamless Brass Spout

Compared to traditional tubular spouts on the market, this spout boasts a .09" wall thickness which provides superior force and vandal resistance.

Smooth-End Spout

This maintenance-free laminar flow outlet has the flow control located in the base of the spout, and the chrome-plated smooth end eliminates crevices for bacteria to form.

Limited Swing Gooseneck

Available in multiple sizes, this option limits movement of the spout to a maximum 120° rotation.

4" Blade Handles with Sanitary Hood

These vandal-resistant handles are designed to help prevent the growth of bacteria. The sanitary hood feature provides significantly less areas for bacteria to collect.



4" Center set Faucet
21C143



- Cast brass body
- Vandal-resistant 3" hooded lever handles
- CER-TECK® ceramic disk cartridge
- 1.5 gpm outlet



4" Center set Faucet
21C142



- Cast brass body
- Vandal-resistant 4" hooded blade handles
- CER-TECK ceramic disk cartridge
- 1.5 gpm outlet



4" Center set Faucet
2529LF-LGHGMHDF



- Vandal-resistant wrist blade handles
- 0.5 gpm outlet



6"-12" Widespread Faucet
23C333



- Vandal-resistant 3" hooded lever handles
- CER-TECK ceramic disk cartridge
- 1.5 gpm outlet



6"-12" Widespread Faucet
23C342



- Vandal-resistant 3" hooded blade handles
- CER-TECK ceramic disk cartridge
- 1.5 gpm outlet



6"-16" Widespread Faucet
3549LF-WFLGHDF



- Vandal-resistant wrist blade handles
- Vandal-resistant aerator
- 1.5 gpm outlet



6"-12" Widespread Faucet
23C674-LS



- Vandal-resistant 4" blade handles with sanitary hood
- Laminar flow control smooth-end spout (1.0 gpm)
- CER-TECK ceramic disk cartridge
- Limited swing 120° gooseneck spout



6"-12" Widespread Faucet
23C642



- Vandal-resistant 4" hooded blade handles
- CER-TECK ceramic disk cartridge
- 1.5 gpm outlet
- Rigid/swivel gooseneck spout



6"-16" Widespread Faucet
3579LF-WFLGHDF



- Vandal-resistant wrist blade handles
- 1.5 gpm outlet
- Rigid gooseneck spout

For additional information on the models shown here, as well as other available models, please go to www.specselect.com.

Cast Brass Body

Construction of this faucet offers little opportunity for bacteria to collect and makes cleaning easy.

Water-Efficient Outlet

Comes standard with a 0.5 gpm flow rate. Each handle is set not to exceed a flow of 0.25 gallons per activation.



Adjustable

Easily adjust the run time to match your water pressure.

ADA Tip Action Lever Handles

Offer ease of use and meet ADA standards—a feature not typically offered in metering faucets.





Single-Hole Faucet
87T104



- Cast brass body
- Vandal-resistant push-style handle and outlet
- Adjustable close time



Single-Hole Faucet
87T105



- Cast brass body
- Vandal-resistant tip action lever handle and outlet
- Adjustable close time



4" Centerset Faucet
86T1153



- Cast brass body
- Vandal-resistant tip action lever handles and outlet
- Adjustable close time



Single-Hole Faucet
701LF-HDF



- Vandal-resistant push-style handle and outlet
- Adjustable close time



4" Centerset Faucet
2507LF-HDF



- Vandal-resistant push-style handles and outlet
- Adjustable close time

Easy to Install and Adjust

Right out of the box, the batteries are already installed and setup is a breeze with adjustable settings.

Vandal-Resistant

All metal heavy-duty construction. Chloramine-resistant diaphragm.

Cost-Effective, Hands-Free Upgrade for Your Manual System

Retrofit an electronic flush valve onto an existing manual unit with a simple kit.





Exposed Electronic Flush Valves with Wall Mount Sensors
81T201-48-WMSHWA – Hardwire (water closet)
81T231-WMSHWA – Hardwire (urinal)



- Featuring H₂Optics® Sensing Technology
- Chloramine-resistant diaphragm
- Electronic manual override button
- Vandal-resistant stainless steel cover
- Factory set to 1.27 gallon flush for water closets and 0.5 gallon flush for urinals—field adjustable



Exposed Electronic Urinal Flush Valve
81T231HWA – Hardwire
81T231BTA – Battery



- Featuring H₂Optics Sensing Technology
- Chloramine-resistant diaphragm
- Electronic override button
- Scratch-resistant replaceable lens window
- Factory set to 0.5 gallon flush—field adjustable
- 81T231BTA-MMO: Battery-operated with mechanical override option



Exposed Electronic Water Closet Flush Valve
81T201HWA – Hardwire
81T201BTA – Battery



- Featuring H₂Optics Sensing Technology
- Chloramine-resistant diaphragm
- Electronic override button
- Scratch-resistant replaceable lens window
- Factory set to 1.6 gallon flush—field adjustable
- 81T201BTA-MMO: Battery-operated with mechanical override option
- 81T201BTA-42-MMO: Battery-operated with 1.1 gallon fixed flush volume
- 81T201HWA-42-MMO: Hardwire with 1.1 gallon fixed flush volume



Concealed Electronic Washdown Urinal Flush Valve
1600T9001RI – Rough-in (hardwire)
1600T9001TR – Trim (hardwire)



- Featuring H₂Optics Sensing Technology
- Electronic manual override button
- Vandal-resistant stainless steel cover
- Available in various rough-in and trim options
- Factory plumbed for easy installation
- Factory set to 0.5 gallon flush—field adjustable

Note: Model must be installed on fixtures providing sufficient air gap protection against backflow.



Concealed Electronic Flush Valve for Wall-Hung Water Closet
1600T6103ARI – Rough-in (hardwire)
1600T6103ATR – Trim (hardwire)



- Featuring H₂Optics Sensing Technology
- Electronic manual override button
- Water closet and urinal models available
- Vandal-resistant stainless steel cover
- Available in various rough-in and trim options
- Factory plumbed for easy installation
- Factory set to 1.6 gallon flush—field adjustable



Side Mount Electronic Flush Kit
DEFM-100



- Retrofit model
- Battery operation
- For use on 81T Teck® exposed manual flush valves and 86T flush valves for washdown urinals
- Can also be used on Sloan® Crane and some Zurn® models
- Standard infrared sensing
- Courtesy manual flush button



Electronic Flush Retrofit Kit for Delta® Valves
81T201BTA-20 – Battery (water closet)
81T201HWA-20 – Hardwire (water closet)



- Retrofit model
- Featuring H₂Optics Sensing Technology
- Complete valve less stop, cover tube and wall flange
- Chloramine-resistant diaphragm
- Electronic override button
- Scratch-resistant replaceable lens window
- Factory set to 1.6 gallon flush—field adjustable



Electronic Flush Retrofit Kit
81TWCBTRKA – Water closet
81TURBTRKA – Urinal



- Retrofit model
- Featuring H₂Optics Sensing Technology
- Battery operation
- Converts manual exposed flush valves to electronics
- New diaphragm, seat and filter screen included
- For hardwire kit, order 061069A
- Scratch-resistant replaceable lens window
- Factory set to 1.6 gallon flush for water closets and 0.5 gallon flush for urinals—field adjustable



Electronic Flush Retrofit Kit for Sloan®/Zurn® Valves
81T231BTA-30 – Battery (urinal)
81T231HWA-30 – Hardwire (urinal)



- Retrofit model
- Featuring H₂Optics Sensing Technology
- Complete valve less stop with modified tail to fit Sloan/Zurn stop
- Chloramine-resistant diaphragm
- Electronic override button
- Scratch-resistant replaceable lens window
- Factory set to 0.5 gallon flush—field adjustable

Hardwire models are also available with the battery backup option referenced on page 4.

For additional information on the models shown here, as well as other available models, please go to www.specselect.com.



Features of the Delta® Flush Valve:

- Non-hold open handle
- Chloramine-resistant diaphragm
- Easily adjustable settings
- All metal heavy-duty construction
- Optional trap seal primer
- Constant peak flow





Electronic Washdown Urinal Flush Valve
DEMD-86505



- Battery operation
- Standard infrared sensing
- Adjustable sensor range
- Remote control available
- Factory set to 0.5 gallon flush—field adjustable

Note: Model must be installed on fixtures providing sufficient air gap protection against backflow.



Water Closet Flush Valve
81T201



- Chloramine-resistant diaphragm
- ADA vandal-resistant non-hold open handle
- Factory set to 1.6 gallon flush—field adjustable



Urinal Flush Valve
81T231



- Chloramine-resistant diaphragm
- ADA vandal-resistant non-hold open handle
- Factory set to 0.5 gallon flush—field adjustable



Flush Valve for Washdown Urinal
86T505



- ADA vandal-resistant handle
- Back inlet stop for 1/2" supply
- Factory set to 0.5 gallon flush—field adjustable

Note: Model must be installed on fixtures providing sufficient air gap protection against backflow.

Hardwire models are also available with the battery backup option referenced on page 4.

For additional information on the models shown here, as well as other available models, please go to www.specselect.com.



Because our products do their job,
you're free to concentrate on yours.

Successful healthcare depends on reliable tools. Delta® offers a broad range of products for the industry—and we're always designing new innovations, to offer professionals even more convenience.

HEALTHCARE





3000T3370A, 24T3003



Electronic Wall Mount Faucet
1501T4670



- Featuring H2Optics® Sensing Technology
- Wall mount rigid gooseneck spout with integral sensor in base
- Adjustable sensing range and time out
- Battery operation
- Smooth-end spout with 1.5 gpm laminar flow control outlet



Electronic Deck Mount Faucet
1501T3370



- Featuring H2Optics Sensing Technology
- Rigid gooseneck spout with integral sensor in base
- Adjustable sensing range and time out
- Battery operation
- Smooth-end spout with 1.5 gpm laminar flow control outlet
- Single-hole model—also available in 4" and 8" options



Electronic Deck Mount Faucet
3001T3420A



- Featuring H2Optics Sensing Technology
- Control module with LCD screen—six programmable settings
- Rigid gooseneck spout with integral sensor in base
- Battery operation
- 1.5 gpm vandal-resistant laminar with Agion® antimicrobial outlet
- 4" model—also available in single-hole and 8" options

General Surgeon Scrub Up



Electronic Deck Mount Faucet
3000T3370A



- Featuring H₂Optics Sensing Technology
- Control module with LCD screen
- Rigid gooseneck spout with integral sensor in base
- Hardwire operation
- Smooth end spout with 1.5 gpm laminar flow control outlet



Above Deck Mixing Valve
for 1500T & 3000T Models
24T3003



- Single-control mixing valve
- Vandal-resistant 6" elbow handle
- Handle rotation limit stop
- For use with surface mount control box models



Surgeon Scrub Faucet
54T5432A



- Floor mount self-close double foot pedal valve
- Deck mount rigid/swivel gooseneck spout
- Vandal-resistant 1.5 gpm laminar with Agion® antimicrobial outlet



3000T Series Touch Pad Control Module with LCD
Screen (Standard with 3000T Series Products)

Adjustable Settings

- Run time—length of time water runs after user removes hands from sensing zone.
- Sense time—response time for sensor to react to hands placed in sensing zone.
- Block time—time required between uses; prevents faucet from running water excessively.
- Sensor range—distance at which sensor detects hands in wash area.
- Auto timer—length of time before faucet stops running in the event the sensor is obstructed by foreign object.
- Metering mode—allows for continuous flow for a set amount of time (7 to 240 seconds, if enabled).
- Self tests for troubleshooting.
- Supplies diagnostic usage information.



3-Position Switch
(060651A or -KS Suffix with 1500T3 and
3000T Products)

- Designed so healthcare facilities can continue to follow infectious control procedures.

Switch Settings

- ON – Solenoid goes into continuous run so water lines can be flushed with high-temperature water.
– Do not exceed 71° C (160° F) during flushing of lines as higher temperatures may damage sensor components.
- AUTO – Faucet functions according to regular settings.
- OFF – Solenoid is blocked from operating so cleaning staff can clean sink without faucet operating.



Surgeon Scrub Faucet
54T5332A



- Wall mount self-close double foot pedal valve
- Deck mount rigid/swivel gooseneck spout
- Vandal-resistant 1.5 gpm laminar with Agion® antimicrobial outlet

A selection of hands-free and electronic products that provide leading functionality, combining ease of use and ADA compliance while maintaining a sleek, low-profile design.



Single Wall Mount Sensor Lavatory
3000T4328ATR – Trim (hardwire)
3000T4328ARI – Rough-in (hardwire)



- H2Optics® Sensing Technology
- 4-1/2" stainless steel wall plates
- Rigid stub spout
- Field-adjustable sensor range and metering mode
- 1.5 gpm swivel laminar outlet
- Transformer required—order separately



Double Wall Mount Sensor Lavatory
3000T4128ARI – Rough-in (hardwire)
3000T4128ATR – Trim (hardwire)



- H2Optics Sensing Technology
- 4-1/2" stainless steel wall plates
- Rigid stub spout
- Field-adjustable sensor range and metering mode
- 1.5 gpm swivel laminar outlet
- Transformer required—order separately



Push-Button Electronic Shower System
860T178



- Recessed metal box mount with thermostatic mixing valve
- Field adjustable shower time
- 30° vandal-resistant forged showerhead
- Hardwire operation
- 1.5 gpm showerhead
- Transformer required, order separately



Wall Mount Double Foot Pedal Valve Bedpan Cleanser
54T1434A



- Wall-mounted vacuum breaker
- Reinforced hose and hanger
- Insulated handle on wand
- Spray outlet with stop



Wall Mount Bedpan Cleanser
54T1104



- Double check vacuum breaker
- Reinforced hose and hanger
- Insulated handle on wand
- Spray outlet with stop



54T1104

For additional information on the models shown here, as well as other available models, please go to www.specselect.com.



W6635DW

Services available for ball valves:

- Air
- Argon
- Cold Water
- Natural Gas
- Nitrogen
- Propane
- Vacuum

Refer to www.specselect.com for Valve/Service combination availability.



Single Shank Deck Mount
Mixing Faucet
W6760-9

- Dual-check in-line vacuum breaker
- 1/4" I.D. 10 serrated nozzle outlet
- Maximum 1.5" diameter deck hole



Deck Mount Mixing Faucet
W6700-9

- Dual-check in-line vacuum breaker
- 1/4" I.D. 10 serrated nozzle outlet
- 2-hole installation at 2.75" centers



Single Deck Mount Water Faucet
W6600-10

- Angle atmospheric vacuum breaker
- 1/4" I.D. 10 serrated nozzle outlet
- Maximum 1.25" diameter deck hole



Deck Mount Turret
W6210GAS



- Single ball valve in deck mount turret
- Available in various configurations and services



Deck Mount Turret
W6220GAS



- Two ball valves at 90° in deck mount turret
- Available in various configurations and services



Pure Water Faucet
W6635DW

- Self-close Celcon® valve
- Gooseneck spout with Tygon® liner



Our universal design solutions
offer safety with style.

For more than half a century, Delta® Faucet has studied the daily relationships between people and water. Our observations have led to the discoveries of unspoken needs—and from there, to the creation of groundbreaking styles and technologies.

Through our broad array of product innovations, we continue to make a difference for people of all ages and abilities, in all settings: helping their interactions with water to become more accessible, more enjoyable, and more transformative.

UNIVERSAL DESIGN





Traditional



Déco Assist
Tissue Holder/Assist Bar
41350

- 6" long
- 7/8" diameter assist bar
- Pivoting arm
- Also available in Polished Nickel



Déco Assist
Corner Shelf/Assist Bar
41316

- 8-3/4" wide
- 7/8" diameter assist bar
- Also available in Polished Nickel



Déco Assist
Double Towel/Assist Bar
41319

- 24" long
- 7/8" diameter assist bar
- Also available in Polished Nickel

Transitional



Déco Assist
Tissue Holder/Assist Bar
41450

- 6" long
- 7/8" diameter assist bar
- Pivoting arm



Déco Assist
Corner Shelf/Assist Bar
41416

- 9-1/2" wide
- 7/8" diameter assist bar



Déco Assist
Double Towel/Assist Bar
41419

- 24" long
- 7/8" diameter assist bar

Contemporary



Déco Assist
Tissue Holder/Assist Bar
41550

- 6" long
- 7/8" diameter assist bar
- Pivoting arm



Déco Assist
Corner Shelf/Assist Bar
41516

- 9-1/8" wide
- 7/8" diameter assist bar



Déco Assist
Double Towel/Assist Bar
41519

- 24" long
- 7/8" diameter assist bar



Chrome Champagne Bronze CZ Polished Nickel PN Venetian Bronze RB Brilliance® Stainless SS

Available on
select models only.

The products on this page are shown in Chrome.

While Décor Assist products meet ADA load requirements, they are not ADA-compliant due to size standards.



41618-SS

Grab Bars



1-1/2" x 24" Grab Bar
40124-SS



- Brilliance® Stainless finish
- For persons up to 500 pounds
- Concealed mounting
- Also available in lengths of 18", 30", 36", 42", and 48"



1-1/4" x 24" Grab Bar
41124-SS



- Brilliance® Stainless finish
- For persons up to 500 pounds
- Concealed mounting
- Also available in lengths of 30", 36", and 42"



1-1/4" x 24" Grab Bar With Decorative Flanges
41224-SN



- Satin Nickel finish
- For persons up to 500 pounds
- Concealed mounting
- Also available in 18" length

Traditional



- 41612 12" Decorative ADA Grab Bar
- 41618 18" Decorative ADA Grab Bar
- 41624 24" Decorative ADA Grab Bar
- 41636 36" Decorative ADA Grab Bar
- 41642 42" Decorative ADA Grab Bar

- 1-1/4" diameter
- For persons up to 500 pounds
- Concealed mounting

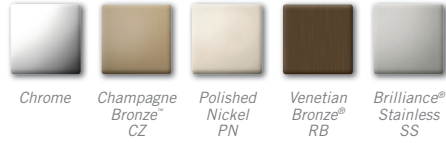

Transitional



- 41712 12" Decorative ADA Grab Bar
- 41718 18" Decorative ADA Grab Bar
- 41724 24" Decorative ADA Grab Bar
- 41736 36" Decorative ADA Grab Bar
- 41742 42" Decorative ADA Grab Bar

- 1-1/4" diameter
- For persons up to 500 pounds
- Concealed mounting



Contemporary



- 41812 12" Decorative ADA Grab Bar
- 41818 18" Decorative ADA Grab Bar
- 41824 24" Decorative ADA Grab Bar
- 41836 36" Decorative ADA Grab Bar
- 41842 42" Decorative ADA Grab Bar

- 1-1/4" diameter
- For persons up to 500 pounds
- Concealed mounting

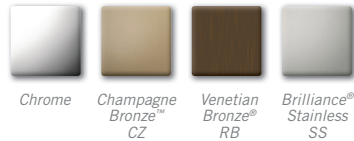

Angular Modern



- 41912 12" Decorative ADA Grab Bar
- 41918 18" Decorative ADA Grab Bar
- 41924 24" Decorative ADA Grab Bar
- 41936 36" Decorative ADA Grab Bar
- 41942 42" Decorative ADA Grab Bar

- 1-1/4" diameter
- For persons up to 500 pounds
- Concealed mounting

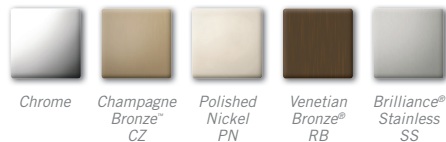

Adjustable Handle Limit Stop

Limits the movement of the handle into the “hot” zone.

ADA-Compliant Lever Handle

Allows you to carry a stylish design throughout your entire facility.



DIAMOND™ Valve

Embedded with diamonds for incredible durability, and designed and tested to perform like new for life.



Single-Lever Kitchen Faucet
100LF-HDF



- Vandal-resistant elbow handle and 1.5 gpm outlet
- Swivel spout
- 3-hole installation
- Adjustable handle limit stop
- DIAMOND™ Valve



Single-Lever Kitchen Faucet
101LF-HDF



- Vandal-resistant elbow lever handle and 1.5 gpm outlet
- Swivel spout
- Single-hole installation
- Adjustable handle limit stop
- DIAMOND™ Valve



8" Deck Mount Single-Lever Kitchen Faucet
400LF-HDF



- Matching finish side sprayer
- Vandal-resistant elbow lever handle and 1.5 gpm outlet
- 4-hole installation
- Adjustable handle limit stop
- DIAMOND™ Valve



Single-Lever Utility Faucet
710LF-HDF



- Vandal-resistant elbow handle and 1.5 gpm outlet
- 10"-high rigid spout
- 2-hole installation
- Adjustable handle limit stop
- DIAMOND™ Valve



Single-Lever Pantry Faucet
27C643



- Vandal-resistant lever handle
- 1.5 gpm outlet
- Single-hole installation
- Rigid/swivel gooseneck spout
- CER-TECK® ceramic disk cartridge



Seamless Brass Spout

Compared to traditional tubular spouts on the market, this spout boasts a .09" wall thickness, which provides superior force and vandal resistance.

Water-Efficient Outlet

Available in five optional reduced flow outlets, ranging from 0.5 gpm to 1.5 gpm.

Rigid/Swivel Gooseneck Spout

Optional brass collar is supplied to accommodate rigid or swivel installation needs. Limited swing also available.

Cast Brass Body

Construction of this faucet offers little opportunity for bacteria to collect and makes cleaning easy.

DELTA
®





8" Cast Deck Mount Faucet
26C3942



- Vandal-resistant 4" hooded blade handles
- 3-hole installation
- 1.5 gpm outlet
- Rigid/swivel gooseneck spout
- CER-TECK® ceramic disk cartridge



Single Shank Mixing Faucet
25C3847



- Vandal-resistant 2-1/2" balanced lever handles
- Single-hole installation
- 1.5 gpm outlet
- Rigid/swivel gooseneck spout
- CER-TECK ceramic disk cartridge



8" Below Deck Mount Faucet
27C2923



- Vandal-resistant 1.5 gpm laminar with Agion® antimicrobial outlet
- Vandal-resistant 3" hooded lever handles
- 3-hole installation
- Rigid/swivel gooseneck spout
- CER-TECK ceramic disk cartridge



4" Cast Deck Mount Faucet
27C4844



- Vandal-resistant 4" blade handles with sanitary hood
- 2-hole installation
- 1.5 gpm outlet
- Rigid/swivel gooseneck spout
- CER-TECK ceramic disk cartridge



8" Center Wall Mount Pre-Rinse Faucet
55C1513



- Vandal-resistant 3" hooded lever handles
- Supplied with standard 1.6 gpm spray outlet and water/energy-saving 1.2 gpm option
- Includes auto shut-off
- CER-TECK ceramic disk cartridge

ADA Handle Options



- 4" Hooded Blade
(Available with optional red/blue temperature indicator)



- 3" Hooded Lever
(Available with optional red/blue temperature indicator)



- 4" Blade with Sanitary Hood
(Available with optional red/blue temperature indicator—shown above)



- 6" Wrist with Sanitary Hood



A chrome faucet is mounted on a wall of light brown, square tiles. The faucet has a central spout with a vacuum breaker and a garden hose end. It features two side handles and a wall brace that extends upwards and then down to the faucet body. A mop is visible on the left side of the frame.

Wall Brace

Reinforces the faucet-to-wall connection and helps to support heavy pails of water.

Integral Checks

Eliminate crossflow—preventing the hot water from traveling to the cold side and vice versa.

Integral Stops

Allow for ease of maintenance—no need to shut the entire water supply off when you can do it right at the faucet.

Body-Mounted Vacuum Breaker with Garden Hose End

The vacuum breaker prevents backflow of sink water into potable water system. The standard hose-end spout makes adding and removing garden hoses simple.





8" Center Wall Mount Service Sink Faucet
28C2383



- Cast brass body
- Adjustable top/bottom brace
- Body-mounted angle vacuum breaker with garden-hose end
- Includes integral check stops
- Vandal-resistant 3" hooded lever handles
- CER-TECK® ceramic disk cartridge



8" Center Wall Mount Service Sink Faucet
28C8073



- Cast brass body
- Spout end vacuum breaker with garden-hose end
- Includes 48" hose and stainless steel hanger
- Includes integral check stops
- Vandal-resistant 3" hooded lever handles
- CER-TECK ceramic disk cartridge



8" Center Wall Mount Service Sink Faucet
28T9

- Cast brass body
- Includes integral stops
- In-line vacuum breaker with garden-hose end
- Metal cross handles
- Compression cartridge



8" Center Wall Mount Sink Faucet
28C4434



- Vandal-resistant 1.5 gpm outlet and 4" blade handles with sanitary hood
- 11" tubular swing spout
- CER-TECK ceramic disk cartridge



8" Center Wall Mount Service Sink Faucet
28P4402LF



- Cast brass body
- Vandal-resistant 1.5 gpm outlet and 4" hooded blade handles
- 8" long spout—swings 360°
- Less integral stops



8" Center Wall Mount Service Sink Faucet
28C9LH



- Cast brass body
- Includes integral stops
- In-line vacuum breaker with garden-hose end
- 4" metal lever handles
- 1/4-turn ceramic cartridge

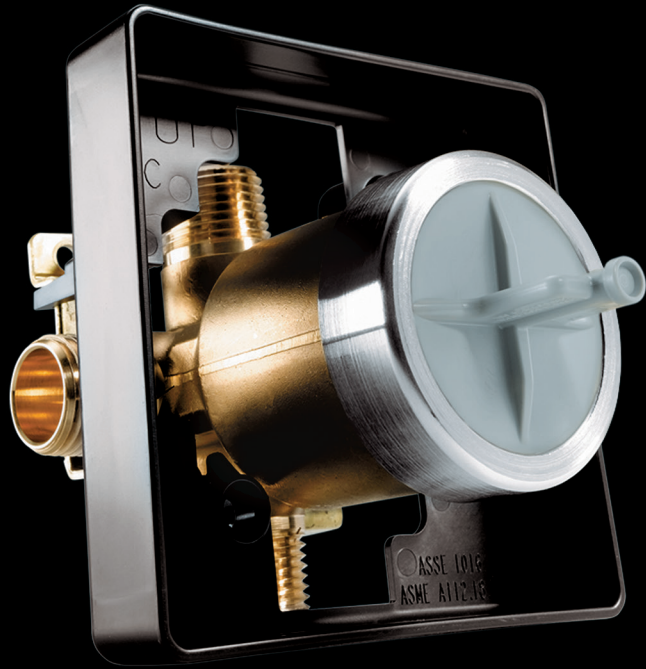

THE DELTA® MULTICHOICE® UNIVERSAL ROUGH-IN.

Flexibility that saves time and money.

Installing the Delta MultiChoice Universal Rough-in makes it easier to upgrade style, finish and functionality at any time. Because there's no need to alter plumbing behind the wall, you can save time, effort and money on mid-construction changes and renovation updates.

One rough. Unlimited possibilities.

Mounting Bracket

Provides a sturdy method to secure the valve to a stringer and prevents rocking.

Square Plasterguard

The size of a standard tile allows for simple 90° cuts. Snaps into place with no tools required to remove.

R10300-UNWS MultiChoice Universal Valve Body with Push-Button Diverter

WS—with stops recommended for Commercial applications.



Three Connection Types

Provides universal connection options for every type of piping—IPS, PEX and UNIVERSAL.

Heat-Resistant Pressure Test Cap

Allows for air or water testing before the valve cartridge is installed up to 300 psi. Easy access for flushing out the system.



Single-Function Pressure-Balanced Valve Cartridge

Functions with a single control for temperature only.



Dual-Function Pressure-Balanced Valve Cartridge

Offers independent control of temperature and volume by balancing the pressure of hot and cold water.



Dual-Function Thermostatic Valve Cartridge

Keeps water temperature consistent by actually measuring and monitoring the temperature of the water and automatically adjusting the water mix to maintain a more precise water temperature.

Delta offers trim choices in traditional, transitional, and contemporary styles—making it easy to find a look that realizes the vision of any design, construction or facility team.



TRADITIONAL



TRANSITIONAL



CONTEMPORARY



Adjustable Showerhead
Allows users to select their preference between full, massage and combination settings.

Diverter Valve
Makes it easy for the user to switch between the showerhead and handshower.

MultiChoice® Universal
Provides unparalleled flexibility with multiple cartridge options.

Optional Double Spiral Hose
This hose is ideal for Commercial applications.

Stainless Steel Bar with ADA Slide
When installed according to spec, this stainless steel bar serves as both a slide bar and an ADA-compliant bar.



Tub and Shower with H₂Okinetic® Showerhead
T13H283 – Trim
R10000-UNWS – Rough-in



- MultiChoice® Universal pressure-balance tub and shower
- H₂Okinetic water-efficient 1.5 gpm showerhead
- Vandal-resistant lever blade handle
- Escutcheon with non-removable red/blue marking



Shower
T13H123 – Trim
R10000-UNWS – Rough-in



- MultiChoice Universal pressure-balance shower
- Touch-Clean® 3-setting 2.0 gpm showerhead
- Vandal-resistant lever blade handle
- Escutcheon with non-removable red/blue marking



Tub and Shower
T13H232 – Trim
R10000-UNWS – Rough-in



- MultiChoice Universal pressure-balance tub and shower
- Touch-Clean water-efficient 1.5 gpm showerhead
- Vandal-resistant lever handle
- Escutcheon with non-removable red/blue marking



Shower
T17TH125 – Trim
R10000-UNWS – Rough-in



- TempAssure® thermostatic shower
- Touch-Clean 3-setting 2.0 gpm showerhead
- Tub and shower trim models available
- Vandal-resistant lever handle
- Non-removable red/blue indicators



Shower and Handshower with Wall Bar
T13H322-20 – Trim
R10700-UNWS – Rough-in



- MultiChoice Universal pressure-balance shower with diverter valve
- Touch-Clean 3-setting 2.0 gpm showerhead
- 1.5 gpm handshower with 24" stainless steel bar with ADA adjustable slide
- Brass double spiral hose
- Water-efficient configuration available
- Escutcheon with non-removable red/blue marking
- Two check valves in handshower



Handshower with Wall Bar
T17TH155 – Trim
R10000-UNWS – Rough-in



- TempAssure thermostatic shower
- Touch-Clean 2-setting 2.5 gpm handshower
- 24" stainless steel bar with ADA adjustable slide
- Vandal-resistant lever handle
- Non-removable red/blue indicators
- Two check valves in handshower



Tub and Shower
T13490 – Trim
R10000-UNWS – Rough-in



- MultiChoice Universal pressure-balance tub and shower
- Touch-Clean 2.0 gpm showerhead
- Vandal-resistant lever blade handle
- Red/blue indicators



Tub and Shower with Push-Button Diverter
T13691 – Trim
R10300-UNWS – Rough-in



- MultiChoice Universal pressure-balance tub and shower
- Touch-Clean 2.0 gpm showerhead
- Integral push-button diverter
- Non-removable red/blue indicators



Push-Button Electronic Shower System
860T167 – Hardwire
861T167 – Battery



- Recessed metal box with pressure-balance mixing valve
- 30° vandal-resistant handle and 1.5 gpm showerhead
- Available with various mixing and showerhead options
- Field adjustable shower time



RP46384



H2OkinetiC® Multi-Setting Showerhead
52637-15-PK



- 5 Setting
- 1.5 gpm

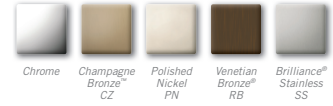

H2OkinetiC In2ition®
4-Setting Shower
58473



- Integrated showerhead and handshower
- 2.0 gpm

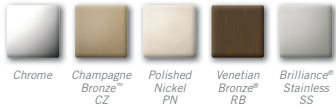

H2OkinetiC In2ition
4-Setting Shower
58471-PK



- Integrated showerhead and handshower
- 2.5 gpm

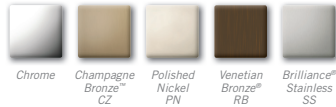

H2OkinetiC In2ition
4-Setting Shower
58472



- Integrated showerhead and handshower
- 2.5 gpm



H2OkinetiC 5.5\"/>

- 2.0 gpm

RP70175-15

- 1.5 gpm



H2OkinetiC 6\"/>



- Single Setting
- 2.0 gpm

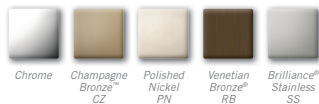

H2OkinetiC 6.5\"/>



- Single Setting
- 2.0 gpm





H2Okinetic Multi-Setting Showerhead
52638-20-PK



- 5 Setting
- 2.0 gpm

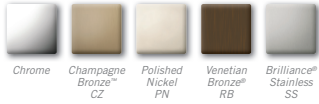

H2Okinetic Water-Efficient Showerhead
RP46384



- Single Setting
- 1.5 gpm



H2Okinetic Showerhead
52655



- Single Setting
- 1.5 gpm



Touch-Clean® Showerhead
RP43381



- 3 Setting
- 2.0 gpm

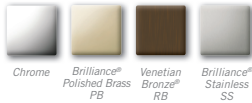

Touch-Clean Showerhead
RP38357



- Single Setting
- 2.0 gpm



Touch-Clean Showerhead
52672-15-BG



- Single Setting
- 1.5 gpm



30° Vandal-Resistant Cast Wall Mount Showerhead
060793A

- 2.0 gpm

- 060991A
- 1.75 gpm

- 061011A
- 1.5 gpm



30° Vandal-Resistant Forged Brass Wall Mount Showerhead
063214A

- 2.0 gpm

- 063213A
- 1.75 gpm

- 063196A
- 1.5 gpm



Bent Shower Arm and Flange
060710A

- Metal set screw wall flange



The products on this spread are shown in Chrome. All products on this spread come without shower arm and flange, unless indicated otherwise.



54445-SS-PK



H2Okinetic® Shower Mount Handshower 54433-PK



- 3 Setting
- 2.0 gpm
- Pause feature

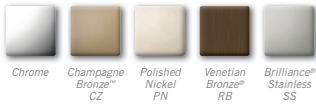

H2Okinetic Wall Mount Handshower 55411



- Single Setting
- 2.0 gpm



H2Okinetic Shower Mount Handshower 54411-PK



- Single Setting
- 2.0 gpm



H2Okinetic Shower Mount Handshower 54421-PK



- Single Setting
- 2.0 gpm

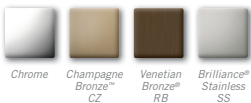

H2Okinetic Shower Mount Handshower 54445-PK



- 5 Setting
- 2.0 gpm
- Pause feature



H2Okinetic Handshower with Slide Bar 51567



- Single Setting
- 2.0 gpm



Touch-Clean Handshower 59462-B15-BG



- 2 Setting
- 1.5 gpm
- Pause feature



All handshowers on this page are shown in Chrome, and come without wall elbow, shower arm and flange, unless indicated otherwise.



3568LF-SSMPU, 41924-SS,
45568-SS, 44080-SS

Bathroom



24" Brass Towel Shelf With Towel Bar
43024

- Concealed mounting
- Mounting hardware included



24" Brass Towel Shelf With Double Towel Bar
43424

- Concealed mounting
- Mounting hardware included



1" x 5' Curved Shower Rod With Brackets
42205-ST

- Adjustable length
- Oval design prevents rotation
- Also available in 6' length



Recessed Paper Holder with Plastic Roller
45070-ST

- Plastic spring-activated roller
- Twin side-by-side model available



Recessed Extra Roll Paper Holder
45470-ST

- Plastic spring-activated roller
- Stores extra roll behind roll in use



Twin Paper Holder
45272

- Two brass spring-activated rollers

Public Washroom



Recessed Towel Dispenser and Waste Receptacle
45568-SS

- Holds 475 multi-fold or 350 C-fold towels
- Removable 2-gallon waste receptacle
- Includes tumbler lock and key



Vertical Liquid Soap Dispenser
44080-SS

- 40 oz. capacity
- Shut-off soap valve
- Mounting hardware included



Toilet Seat Cover Cabinet
49000-SS

- 500 seat cover capacity
- Mounting hardware included

Drains



Grid Strainer
33T260-1

- Open grid strainer less overflow holes
- With overflow holes model available (33T260)
- Less overflow holes, with splash reduction drain cover (33T260-1DC)



Grid Strainer
33T290-1



- Offset open grid strainer less overflow holes
- With overflow holes model available (33T290)
- Less overflow holes, with splash reduction drain cover (33T290-1DC)



Cast P-Trap
33T311 – 1-1/4"
33T360 – 1-1/2"

- With cleanout
- Adjustable





**COMMERCIAL
PRICE BOOK
2016 | 2017**
EFFECTIVE: 05.01.16



DELTA COMMERCIAL specselect

Catalog Index Parts Commercial Site Built File Library



Proximity Sensing Technology

more features

Proximity Sensing Technology is the next generation in responsive sensors that functionality. This revolutionary technology transforms the entire sensor into a sensor automatically responding when approached.









Site Requirements Website Support Content Editor Privacy Policy Privacy Statement About Us Contact Us Create Your Account



Quick Pick Products

Delta® understands the importance of completing projects in a timely manner and we would like to guide you with selecting the right product in the most user-friendly and efficient way. The Quick Pick section will provide you with a list of some of our most popular and newest models, along with information on pricing, finish options and product features. We believe Quick Pick provides you with a convenient selection process for when you are ready to place your order.

Please always order in full case. Delta Commercial Technical Service 1-877-509-2680.
Online Catalogs: www.deltacommercialfaucets.com (Core products ONLY)
www.specselect.com (Complete Product Offering & Part Numbering System)

	Model	Case	Price	Finish	Features
	Classic <i>Single Handle Kitchen Faucet</i>				<ul style="list-style-type: none"> • 3-hole 8" installation • Standard spout swivels 180° • 8 11/16" long, 9 1/8" high • 4 3/4" from deck to aerator • Vandal resistant lever handle • Red/blue indicator • Vandal resistant aerator • 3/8" O.D. inlets with 3/8" fittings • Includes 1/2" adapters • 2 1/2" max. deck thickness • Straight, staggered supply tubes • 1.5 gpm @ 60 psi, 5.7 L/min @ 414 kPa • DIAMOND™ Valve
	100LF-HDF	6	139.05	Chrome	
					
	Classic <i>Single Handle Kitchen Faucet</i>				<ul style="list-style-type: none"> • 1-hole installation • Standard spout swivels 180° • 8 11/16" long, 8 1/2" high • 4 5/16" from deck to aerator • Vandal resistant lever handle • Red/blue indicator • Vandal resistant aerator • 3/8" O.D. inlets with 3/8" fittings • Includes 1/2" adapters • 2 1/2" max. deck thickness • Straight, staggered supply tubes • 1.5 gpm @ 60 psi, 5.7 L/min @ 414 kPa • DIAMOND™ Valve
	101LF-HDF	6	140.40	Chrome	
					
	Commercial <i>Single Handle Kitchen Faucet with Spray</i>				<ul style="list-style-type: none"> • 4-hole 8" installation • Standard spout swivels 180° • 8 11/16" long, 9 1/8" high • 5" from deck to aerator • Vandal resistant lever handle • Red/blue indicator • Vandal resistant aerator • 3/8" O.D. inlets with 3/8" fittings • Includes 1/2" adapters • 2 1/2" max. deck thickness • Straight, staggered supply tubes • Matching finish spray • 1.5 gpm @ 60 psi, 5.7 L/min @ 414 kPa • DIAMOND™ Valve
	400LF-HDF	6	169.50	Chrome	
					



Commercial
Two Handle Kitchen Faucet

Model	Case	Price	Finish
26C3132	1	241.60	Chrome
26C3142	1	238.00	Chrome

For complete 26C series product offering, see page C111.

- 3-hole 8" installation
- CAST body
- 8" long spout swings 360°
- 5 7/20" from deck to aerator
- Vandal resistant hooded blade handles
- Red/blue indicators
- 26C3132 - Vandal resistant aerator
- 26C3142 - Standard aerator
- 1/2" IPS shanks
- 1 3/4" max. deck thickness
- 1.5 gpm @ 60 psi, 5.7 L/min @ 414 kPa
- CER-TECK® cartridges



Commercial
Two Handle Kitchen Faucet

Model	Case	Price	Finish
26C3133	1	240.30	Chrome
26C3143	1	236.70	Chrome

- 3-hole 8" installation
- CAST body
- 8" long spout swings 360°
- 5 7/20" from deck to aerator
- Vandal resistant lever handles
- Red/blue indicators
- 26C3133 - Vandal resistant aerator
- 26C3143 - Standard aerator
- 1/2" IPS shanks
- 1 3/4" max. deck thickness
- 1.5 gpm @ 60 psi, 5.7 L/min @ 414 kPa
- CER-TECK® cartridges



Commercial
Two Handle Kitchen Faucet

Model	Case	Price	Finish
26C3124	1	268.80	Chrome
26C3134	1	259.50	Chrome
26C3144	1	255.90	Chrome

- 3-hole 8" installation
- CAST body
- 8" long spout swings 360°
- 5 7/20" from deck to aerator
- Vandal resistant sanitary hood blade handles
- Red/blue indicators
- 26C3124 - Vandal resistant laminar outlet w/ Agion® Antimicrobial
- 26C3134 - Vandal resistant aerator
- 26C3144 - Standard aerator
- 1/2" IPS shanks
- 1 3/4" max. deck thickness
- 1.5 gpm @ 60 psi, 5.7 L/min @ 414 kPa
- CER-TECK® cartridges



Commercial
Two Handle Kitchen Faucet

Model	Case	Price	Finish
26C3933	4	245.15	Chrome
26C3943	3	241.55	Chrome

- 3-hole 8" installation
- CAST body
- Rigid/swivel gooseneck spout
- 6" long, 12" high spout
- 6 1/10" from deck to aerator
- Vandal resistant lever handles
- Red/blue indicators
- 26C3933 - Vandal resistant aerator
- 26C3943 - Standard aerator
- 1/2" IPS shanks
- 1 3/4" max. deck thickness
- 1.5 gpm @ 60 psi, 5.7 L/min @ 414 kPa
- CER-TECK® cartridges



Model Case Price Finish

Commercial
Two Handle Kitchen Faucet

26C3924	1	273.65	Chrome
26C3934	1	264.35	Chrome
26C3944	1	260.75	Chrome

For complete 26C series product offering, see page C111.

Features

- 3-hole 8" installation
- CAST body
- Rigid/swivel gooseneck spout
- 6" long, 12" high spout
- 6 1/10" from deck to aerator
- Vandal resistant sanitary hood blade handles
- Red/blue indicators
- 26C3924 - Vandal resistant laminar outlet w/ Agion® Antimicrobial
- 26C3934 - Vandal resistant aerator
- 26C3944 - Standard aerator
- 1/2" IPS shanks
- 1 3/4" max. deck thickness
- 1.5 gpm @ 60 psi, 5.7 L/min @ 414 kPa
- CER-TECK® cartridges



Commercial
Two Handle Kitchen Faucet

27C2933	3	241.35	Chrome
27C2943	3	237.75	Chrome

For complete 27C2 series product offering, see page C112.

- 3-hole 8" installation
- Below deck mount
- Rigid/swivel gooseneck spout
- 6" long, 12" high spout
- 6 9/31" from deck to aerator
- Vandal resistant lever handles
- Red/blue indicator(s)
- 27C2933 - Vandal resistant aerator
- 27C2943 - Standard aerator
- 1 3/50" max. deck thickness
- 1.5 gpm @ 60 psi, 5.7 L/min @ 414 kPa
- CER-TECK® cartridges



Commercial
Two Handle Kitchen Faucet

27C2932	1	242.65	Chrome
27C2942	3	239.05	Chrome

- 3-hole 8" installation
- Below deck mount
- Rigid/swivel gooseneck spout
- 6" long, 12" high spout
- 6 9/31" from deck to aerator
- Vandal resistant hooded blade handles
- Red/blue indicators
- 27C2932 - Vandal resistant aerator
- 27C2942 - Standard aerator
- 1 3/50" max. deck thickness
- 1.5 gpm @ 60 psi, 5.7 L/min @ 414 kPa
- CER-TECK® cartridges



Commercial
Two Handle Kitchen Faucet

27C2924	1	269.85	Chrome
27C2934	1	260.55	Chrome
27C2944	3	256.95	Chrome

- 3-hole 8" installation
- Below deck mount
- Rigid/swivel gooseneck spout
- 6" long, 12" high spout
- 6 9/31" from deck to aerator
- Vandal resistant sanitary hood blade handles
- Red/blue indicator(s)
- 27C2924 - Vandal resistant laminar outlet w/ Agion® Antimicrobial
- 27C2934 - Vandal resistant aerator
- 27C2944 - Standard aerator
- 1 3/50" max. deck thickness
- 1.5 gpm @ 60 psi, 5.7 L/min @ 414 kPa
- CER-TECK® cartridges





Model Case Price Finish

Commercial
Two Handle Kitchen Faucet

27C2974 1 269.85 Chrome

For complete 27C2 series product offering, see page C112.

Features

- 3-hole 8" installation
- Below deck mount
- Rigid/swivel gooseneck spout
- 6" long, 12" high spout
- 7 1/3" from deck to aerator
- Vandal resistant hooded blade handles
- Red/blue indicators
- Standard aerator
- 1 3/50" max. deck thickness
- 1.0 gpm @ 60 psi, 3.8 L/min @ 414 kPa
- CER-TECK® cartridges



Commercial
Two Handle Bar Faucet

2171LF-WBHDF 6 176.30 Chrome

- 2-hole 4" installation
- Spout swings 360°
- 4 5/32" long, 11" high
- Vandal resistant wrist blade handles
- Red/blue indicators
- Vandal resistant aerator
- 1/2" IPS shanks
- 1" max. deck thickness
- 1/4 turn handle stops
- Brass stems/stainless steel plate
- 1.5 gpm @ 60 psi, 5.7 L/min @ 414 kPa



Commercial
Two Handle Bar Faucet

27C4822 1 208.20 Chrome
27C4832 3 198.90 Chrome
27C4842 3 195.30 Chrome

For complete 27C4 series product offering, see page C113.

- 2-hole 4" installation
- CAST body
- Rigid/swivel gooseneck spout
- 4 1/2" long, 12" high spout
- Vandal resistant hooded blade handles
- Red/blue indicators
- 27C4822 - Vandal resistant laminar outlet w/ Agion® Antimicrobial
- 27C4832 - Vandal resistant aerator
- 27C4842 - Standard aerator
- 1/2" IPS shanks
- 1 3/4" max. deck thickness
- 1.5 gpm @ 60 psi, 5.7 L/min @ 414 kPa
- CER-TECK® cartridges



Commercial
Two Handle Bar Faucet

27C4943 3 194.00 Chrome

- 2-hole 4" installation
- CAST body
- Rigid/swivel spout
- 6" long, 12" high spout
- Vandal resistant lever handles
- Red/blue indicators
- Standard aerator
- 1/2" IPS shanks
- 1 3/4" max. deck thickness
- 1.5 gpm @ 60 psi, 5.7 L/min @ 414 kPa
- CER-TECK® cartridges





Model Case Price Finish

Commercial
Two Handle Bar Faucet

27C4924	1	226.10	Chrome
27C4934	1	216.80	Chrome
27C4944	3	213.20	Chrome

For complete 27C4 series product offering, see page C113.

Features

- 2-hole 4" installation
- CAST body
- Rigid/swivel spout
- 6" long, 12" high spout
- Vandal resistant sanitary hood blade handles
- Red/blue indicators
- 27C4924 - Vandal resistant laminar outlet w/ Agion® Antimicrobial
- 27C4934 - Vandal resistant aerator
- 27C4944 - Standard aerator
- 1/2" IPS shanks
- 1 3/4" max. deck thickness
- 1.5 gpm @ 60 psi, 5.7 L/min @ 414 kPa
- CER-TECK® cartridges



Commercial
Two Handle Bar Faucet

25C3837	1	242.80	Chrome
25C3847	1	239.20	Chrome

For complete 25C series product offering, see page C110.

- 1-hole installation
- Rigid/swivel gooseneck spout
- 4 1/2" long, 14 1/4" high spout
- Vandal resistant ADA lever balanced handles
- Red/blue indicators
- 25C3837 - Vandal resistant aerator
- 25C3847 - Standard aerator
- 3/8" compression fittings
- 2" max. deck thickness
- 1.5 gpm @ 60 psi, 5.7 L/min @ 414 kPa
- CER-TECK® cartridges



Commercial
Two Handle Bar Faucet

25C3877	1	252.10	Chrome
---------	---	--------	--------

- 1-hole installation
- Rigid/swivel gooseneck spout
- 4 1/2" long, 14 1/4" high spout
- Vandal resistant ADA lever balanced handles
- Red/blue indicators
- Smooth spout end with laminar flow control in spout base
- 3/8" compression fittings
- 2" max. deck thickness
- 1.0 gpm @ 60 psi, 3.8 L/min @ 414 kPa
- CER-TECK® cartridges



Model Case Price Finish Features



Commercial Service Sink Faucet

28C2383 1 357.55 Chrome

For complete 28C series product offering, see pages C115–C118.

- Wall installation – 8" centers
- Cast body
- Rigid spout with top/bottom brace
- 8" long vacuum breaker spout
- Vandal resistant lever handles
- Red/blue indicators
- Hose thread outlet
- Integral check stops
- CER-TECK® cartridges



Commercial Service Sink Faucet

28C4433 3 255.00 Chrome

- Wall installation – 8" centers
- Cast body
- 11" long spout – swings 360°
- Vandal resistant lever handles
- Red/blue indicators
- Vandal resistant aerator
- Less integral stops
- 1.5 gpm @ 60 psi, 5.7 L/min @ 414 kPa
- CER-TECK® cartridges



Commercial Service Sink Faucet

28T9 4 164.70 Rough Chrome













- Wall installation – 8" centers
- Cast body
- Rigid spout with top brace
- 9 1/2" long vacuum breaker spout
- Cross handles
- Red/blue indicators
- Hose thread outlet
- Vacuum breaker
- Integral stops
- Heavy duty cartridges



Commercial Service Sink Faucet

28C9LH 1 206.90 Rough Chrome

- Wall installation – 8" centers
- Cast body
- Rigid spout with top brace
- 9 1/2" long vacuum breaker spout
- 4" metal lever handles
- Red/blue indicators
- Hose thread outlet
- Vacuum breaker
- Integral stops
- 1/4 turn ceramic cartridges

	Model	Case	Price	Finish	Features	
   	Commercial <i>Service Sink Faucet</i>	28P4902LF	3	209.70	Chrome	<ul style="list-style-type: none"> • Wall installation - 8" centers • Cast body • 8" Gooseneck spout - swings 360° • Supplied with adjustable centers – 175 mm to 235 mm (6.87" to 9.25") • Vandal resistant hooded blade handles • Red/blue indicators • Vandal resistant aerator • Less integral stops • Control mechanism is 1/4 turn cylinder with brass stem, stainless steel plate and non-metallic seats • 1.5 gpm @ 60 psi, 5.7 L/min @ 414 kPa
	Commercial <i>Service Sink Faucet</i>	28P4402LF	3	209.70	Chrome	<ul style="list-style-type: none"> • Wall installation - 8" centers • Cast body • 8" long spout - swings 360° • Supplied with adjustable centers – 175 mm to 235 mm (6.87" to 9.25") • Vandal resistant hooded blade handles • Red/blue indicators • Vandal resistant aerator • Less integral stops • Control mechanism is 1/4 turn cylinder with brass stem, stainless steel plate and non-metallic seats • 1.5 gpm @ 60 psi, 5.7 L/min @ 414 kPa
   	Commercial <i>Service Sink Faucet</i>	28P4202LF	3	209.70	Chrome	<ul style="list-style-type: none"> • Wall installation - 8" centers • Cast body • 9 1/2" long spout - swings 360° • Supplied with adjustable centers – 175 mm to 235 mm (6.87" to 9.25") • Vandal resistant hooded blade handles • Red/blue indicators • Vandal resistant aerator • Less integral stops • Control mechanism is 1/4 turn cylinder with brass stem, stainless steel plate and non-metallic seats • 1.5 gpm @ 60 psi, 5.7 L/min @ 414 kPa
	Commercial <i>Pre-Rinse Wall Mount Faucet</i>	55C1513	1	634.40	Chrome	<ul style="list-style-type: none"> • Wall installation – 8" centers • Cast body • Vandal resistant lever handles • Red/blue indicators • High pressure hose • Stainless steel hose shield • Integral check stops • 12" wall bracket – Thin wall kit • Insulated spray head w/ hook (1.6 gpm @ 60 psi) • Optional water-saver spray plate (1.2 gpm @ 60 psi) • CER-TECK® cartridges <p>For complete 55C series product offering, see page C122.</p>
   						



Model Case Price Finish

Commercial
Single Handle Centerset Lavatory Faucet

Model	Case	Price	Finish
501LF-HDF	6	135.85	Chrome
501LF-HGMHDF	6	138.15	Chrome
501LF-TGMHDF	6	138.15	Chrome

501LF-HGMHDF and 501LF-TGMHDF are not WaterSense® Labeled

- Features**
- 2-hole 4" installation
 - Solid brass fabricated body
 - Rigid spout
 - 5" long, 4 7/8" high
 - 1 11/16" from deck to aerator
 - Vandal resistant lever handle
 - Red/blue indicators
 - Adjustable handle limit stop
 - 2" max. deck thickness
 - Less pop-up
 - No lift rod hole
 - 1/4" threaded mounting studs
 - 3/8" OD straight, 4" spaced copper supply tubes with 1/2" IPS fittings
 - 501LF-TGMHDF - .35 gpm vandal resistant pressure compensating aerator
 - 501LF-HGMHDF - .5 gpm vandal resistant pressure compensating aerator
 - 501LF-HDF - 1.5 gpm vandal resistant aerator @ 60 psi, 5.7 L/min @ 414 kPa
 - 501LF-HDF converts from 1.5 to 1.2 gpm by July 1, 2016
 - DIAMOND™ Valve



Commercial
Single Handle Centerset Lavatory Faucet

Model	Case	Price	Finish
520LF-HDF	6	159.65	Chrome
520LF-HGMHDF	6	162.05	Chrome
520LF-TGMHDF	6	162.05	Chrome

520LF-HGMHDF and 520LF-TGMHDF are not WaterSense® Labeled

- 3-hole 4" installation
- Solid brass fabricated body
- Rigid spout
- 5" long, 4 7/8" high
- 1 11/16" from deck to aerator
- Vandal resistant lever handle
- Red/blue indicators
- Adjustable handle limit stop
- Metal pop-up
- 2" max. deck thickness
- Metal pop-up
- 1/4" threaded mounting studs
- 3/8" OD straight, 4" spaced copper supply tubes with 1/2" IPS fittings
- 520LF-TGMHDF - .35 gpm vandal resistant pressure compensating aerator
- 520LF-HGMHDF - .5 gpm vandal resistant pressure compensating aerator
- 520LF-HDF - 1.5 gpm vandal resistant aerator @ 60 psi, 5.7 L/min @ 414 kPa
- 520LF-HDF converts from 1.5 to 1.2 gpm by July 1, 2016
- DIAMOND™ Valve





Model Case Price Finish

Commercial
Single Handle Centerset Lavatory Faucet

Model	Case	Price	Finish
523LF-HDF	6	155.40	Chrome
523LF-HGMHDF	6	157.75	Chrome
523LF-TGMHDF	6	157.75	Chrome

523LF-HGMHDF and 523LF-TGMHDF are not WaterSense® Labeled

- Features**
- 2-hole 4" installation
 - Solid brass fabricated body
 - Rigid spout
 - 5" long, 4 7/8" high
 - 1 11/16" from deck to aerator
 - Vandal resistant lever handle
 - Red/blue indicators
 - Adjustable handle limit stop
 - 2" max. deck thickness
 - Metal grid strainer
 - No lift rod hole
 - 1/4" threaded mounting studs
 - 3/8" OD straight, 4" spaced copper supply tubes with 1/2" IPS adapters
 - 523LF-TGMHDF - .35 gpm vandal resistant pressure compensating aerator
 - 523LF-HGMHDF - .5 gpm vandal resistant pressure compensating aerator
 - 523LF-HDF - 1.5 gpm vandal resistant aerator @ 60 psi, 5.7 L/min @ 414 kPa
 - 523LF-HDF converts from 1.5 to 1.2 gpm by July 1, 2016
 - DIAMOND™ Valve



Commercial
Single Handle Centerset Lavatory Faucet

Model	Case	Price	Finish
511LF-HDF	6	146.65	Chrome
511LF-HGMHDF	6	148.85	Chrome

511LF-HGMHDF is not WaterSense® Labeled

- 2-hole 4" installation
- Solid brass fabricated body
- Rigid spout
- 5" long, 7 3/8" high
- 1 11/16" from deck to aerator
- Vandal resistant elbow handle
- Red/blue indicator
- Adjustable handle limit stop
- 2" max. deck thickness
- No lift rod hole
- 1/4" threaded mounting studs
- 3/8" OD straight, 4" spaced copper supply tubes with 1/2" IPS adapters
- 511LF-HGMHDF - .5 gpm vandal resistant pressure compensating aerator
- 511LF-HDF - 1.5 gpm vandal resistant aerator @ 60 psi, 5.7 L/min @ 414 kPa
- 511LF-HDF converts from 1.5 to 1.2 gpm by July 1, 2016
- DIAMOND™ Valve



Commercial
Single Handle Centerset Lavatory Faucet

Model	Case	Price	Finish
515LF-HDF	6	170.10	Chrome

- 3-hole 4" installation
- Solid brass fabricated body
- Rigid spout
- 5" long, 7 3/8" high
- 1 11/16" from deck to aerator
- Vandal resistant elbow handle
- Red/blue indicator
- Adjustable handle limit stop
- 2" max. deck thickness
- Metal pop-up
- Vandal resistant aerator
- 1/4" threaded mounting studs
- 3/8" OD straight, 4" spaced copper supply tubes with 1/2" IPS adapters
- 1.5 gpm @ 60 psi, 5.7 L/min @ 414 kPa
- Converts from 1.5 to 1.2 gpm by July 1, 2016
- DIAMOND™ Valve



Model	Case	Price	Finish	Features
-------	------	-------	--------	----------



Commercial
Single Handle Centerset Lavatory Faucet

516LF-HDF	6	165.50	Chrome
516LF-HGMHDF	6	167.80	Chrome

516LF-HGMHDF is not WaterSense® Labeled

- 2-hole 4" installation
- Solid brass fabricated body
- Rigid spout
- 5" long, 7 3/8" high
- 1 11/16" from deck to aerator
- Vandal resistant elbow handle
- Red/blue indicator
- Adjustable handle limit stop
- 2" max. deck thickness
- Metal grid strainer
- 1/4" threaded mounting studs
- 3/8" OD straight, 4" spaced copper supply tubes with 1/2" IPS adapters
- 516LF-HGMHDF - .5 gpm vandal resistant pressure compensating aerator
- 516LF-HDF - 1.5 gpm vandal resistant aerator @ 60 psi, 5.7 L/min @ 414 kPa
- 516LF-HDF converts from 1.5 to 1.2 gpm by July 1, 2016
- DIAMOND™ Valve



Commercial
Single Handle Centerset Lavatory Faucet

22C101	6	164.75	Chrome
--------	---	--------	--------

For complete 22C series product offering, see page C106.

- 3-hole 4" installation
- Cast brass body
- 5 3/4" long rigid spout
- Vandal resistant lever handle
- Red/blue indicator
- 1/2" IPS shanks
- No lift rod hole
- Vandal resistant aerator with wrench flats
- 1.5 gpm @ 60 psi, 5.7 L/min @ 414 kPa
- Ceramic cartridge with rotational limit stop



Commercial
Single Handle Centerset Lavatory Faucet

22C301	6	194.90	Chrome
--------	---	--------	--------

- 3-hole 4" installation
- Cast brass body
- 5 3/4" long rigid spout
- Vandal resistant lever handle
- Red/blue indicator
- 1/2" IPS shanks
- Metal pop-up
- Vandal resistant aerator with wrench flats
- 1.5 gpm @ 60 psi, 5.7 L/min @ 414 kPa
- Ceramic cartridge with rotational limit stop



Commercial
Single Handle Centerset Lavatory Faucet

22C401	6	184.75	Chrome
--------	---	--------	--------

- 3-hole 4" installation
- Cast brass body
- 5 3/4" long rigid spout
- Vandal resistant lever handle
- Red/blue indicator
- 1/2" IPS shanks
- Metal grid strainer
- Vandal resistant aerator with wrench flats
- 1.5 gpm @ 60 psi, 5.7 L/min @ 414 kPa
- Ceramic cartridge with rotational limit stop



Model Case Price Finish Features



Commercial
Single Handle Single Hole Lavatory Faucet

22C601 6 182.25 Chrome

For complete 22C series product offering, see page C106.

- 1-hole installation
- Cast brass body
- 5 5/16" long rigid spout
- Vandal resistant lever handle
- Red/blue indicator
- 3/8" compression fittings
- No lift rod hole
- Vandal resistant aerator with wrench flats
- 1.5 gpm @ 60 psi, 5.7 L/min @ 414 kPa
- Ceramic cartridge with rotational limit stop



Commercial
Single Handle Single Hole Lavatory Faucet

22C801 6 215.80 Chrome

- 1-hole installation
- Cast brass body
- 5 5/16" long rigid spout
- Vandal resistant lever handle
- Red/blue indicator
- 3/8" compression fittings
- Metal pop-up
- Vandal resistant aerator with wrench flats
- 1.5 gpm @ 60 psi, 5.7 L/min @ 414 kPa
- Ceramic cartridge with rotational limit stop



Model Case Price Finish Features



Commercial
Two Handle Centerset Lavatory Faucet

2529LF-HDF 6 189.10 Chrome

- 2-hole 4" installation
- Solid brass fabricated body
- 5 1/4" long, 3 1/4" high
- 2" from deck to aerator
- Vandal resistant wrist blade handles
- Red/blue indicators
- 1 9/16" max. deck thickness
- Grid strainer
- No lift rod hole
- Vandal resistant aerator
- 1/2" IPS shanks
- 1.5 gpm @ 60 psi, 5.7 L/min @ 414 kPa
- Converts from 1.5 to 1.2 gpm by July 1, 2016



Commercial
Two Handle Centerset Lavatory Faucet

2529LF-HDM 6 201.65 Chrome

- 3-hole 4" installation
- Solid brass fabricated body
- 5 1/4" long, 3 1/4" high
- 2" from deck to aerator
- Vandal resistant wrist blade handles
- Red/blue indicators
- 1 9/16" max. deck thickness
- Metal pop-up
- Vandal resistant aerator
- 1/2" IPS shanks
- 1.5 gpm @ 60 psi, 5.7 L/min @ 414 kPa
- Converts from 1.5 to 1.2 gpm by July 1, 2016



Commercial
Two Handle Centerset Lavatory Faucet

2529LF-LGHDF 6 160.60 Chrome

- 2-hole 4" installation
- Solid brass fabricated body
- 5 1/4" long, 3 1/4" high
- 2" from deck to aerator
- Vandal resistant wrist blade handles
- Red/blue indicators
- 1 9/16" max. deck thickness
- Less grid strainer
- No lift rod hole
- Vandal resistant aerator
- 1/2" IPS shanks
- 1.5 gpm @ 60 psi, 5.7 L/min @ 414 kPa
- Converts from 1.5 to 1.2 gpm by July 1, 2016



Commercial
Two Handle Centerset Lavatory Faucet

2529LF-LGHGMHDF 6 163.15 Chrome

- 2-hole 4" installation
- Solid brass fabricated body
- 5 1/4" long, 3 1/4" high
- 2" from deck to aerator
- Vandal resistant wrist blade handles
- Red/blue indicators
- 1 9/16" max. deck thickness
- Less grid strainer
- No lift rod hole
- Vandal resistant pressure compensating aerator
- 1/2" IPS shanks
- .5 gpm @ 60 psi, 1.9 L/min @ 414 kPa
- Converts from 1.5 to 1.2 gpm by July 1, 2016





Commercial
Two Handle Centerset Lavatory Faucet

Model	Case	Price	Finish
21C122	6	175.75	Chrome
21C132	6	166.45	Chrome
21C142	6	162.85	Chrome

For complete 21C series product offering, see page C105.

- Features**
- 2-hole 4" installation
 - Cast brass body
 - Vandal resistant hooded blade handles
 - Red/blue indicators
 - 21C122 - Vandal resistant laminar outlet w/ Agion® Antimicrobial
 - 21C132 - Vandal resistant aerator
 - 21C142 - Standard aerator
 - 1 3/4" max. deck thickness
 - No lift rod hole
 - 1.5 gpm @ 60 psi, 5.7 L/min @ 414 kPa
 - CER-TECK® cartridges



Commercial
Two Handle Centerset Lavatory Faucet

21C133	6	165.15	Chrome
21C143	6	161.55	Chrome

- 2-hole 4" installation
- Cast brass body
- Vandal resistant lever handles
- Red/blue indicators
- 21C133 - Vandal resistant aerator
- 21C143 - Standard aerator
- 1 3/4" max. deck thickness
- No lift rod hole
- 1.5 gpm @ 60 psi, 5.7 L/min @ 414 kPa
- CER-TECK® cartridges



Commercial
Two Handle Centerset Lavatory Faucet

21C134	6	184.35	Chrome
21C144	6	180.75	Chrome

- 2-hole 4" installation
- Cast brass body
- Vandal resistant sanitary hood blade handles
- Red/blue indicators
- 21C134 - Vandal resistant aerator
- 21C144 - Standard aerator
- 1 3/4" max. deck thickness
- No lift rod hole
- 1.5 gpm @ 60 psi, 5.7 L/min @ 414 kPa
- CER-TECK® cartridges



Commercial
Two Handle Centerset Lavatory Faucet

21C233	1	219.50	Chrome
--------	---	--------	--------

- 3-hole 4" installation
- Cast brass body
- Vandal resistant lever handles
- Red/blue indicators
- 1 3/4" max. deck thickness
- Metal pop-up
- Vandal resistant aerator
- 1.5 gpm @ 60 psi, 5.7 L/min @ 414 kPa
- CER-TECK® cartridges







Commercial
Two Handle Centerset Lavatory Faucet

21C133-TI	6	176.05	Chrome
-----------	---	--------	--------

- 2-hole 4" installation
- Cast brass body
- Vandal resistant lever handles
- Red/blue 'H', 'C' handle temperature indicators
- 1 3/4" max. deck thickness
- No lift rod hole
- Vandal resistant aerator
- 1.5 gpm @ 60 psi, 5.7 L/min @ 414 kPa
- CER-TECK® cartridges



Model	Case	Price	Finish	Features
	Commercial <i>Widespread Lavatory Faucet</i>			<ul style="list-style-type: none"> • 3-hole 6"-16" installation • Solid brass fabricated end valves and spout body • 5 1/4" long rigid spout • 2 3/8" from deck to aerator • Vandal resistant wrist blade handles • Red/blue indicators • 1 1/8" max. deck thickness • Grid strainer • No lift rod hole • Vandal resistant aerator • 1/4 turn handle stops • WF =1/2" IPS adapters • 1.5 gpm @ 60 psi, 5.7 L/min @ 414 kPa • Converts from 1.5 to 1.2 gpm by July 1, 2016 • Brass stems/stainless steel plate
3549LF-WFHDF	6	292.40	Chrome	
	Commercial <i>Widespread Lavatory Faucet</i>			<ul style="list-style-type: none"> • 3-hole 6"-16" installation • Solid brass fabricated end valves and spout body • 5 1/4" long rigid spout • 2 3/8" from deck to aerator • Vandal resistant wrist blade handles • Red/blue indicators • 1 1/8" max. deck thickness • No lift rod hole • Vandal resistant aerator • 1/4 turn handle stops • WF =1/2" IPS adapters • 1.5 gpm @ 60 psi, 5.7 L/min @ 414 kPa • Converts from 1.5 to 1.2 gpm by July 1, 2016 • Brass stems/stainless steel plate
3549LF-WFLGHDF	6	267.65	Chrome	
	Commercial <i>Widespread Lavatory Faucet</i>			<ul style="list-style-type: none"> • 3-hole 6"-12" installation • 4 1/2" long rigid cast spout • Vandal resistant hooded blade handles • Red/blue indicators • 23C332 - Vandal resistant aerator • 23C342 - Standard aerator • No lift rod hole • 1.5 gpm @ 60 psi, 5.7 L/min @ 414 kPa • CER-TECK® cartridges
23C332 23C342	1 1	264.20 260.60	Chrome Chrome	
<p>For complete 23C series product offering, see page C108.</p>				
	Commercial <i>Widespread Lavatory Faucet</i>			<ul style="list-style-type: none"> • 3-hole 6"-12" installation • 4 1/2" long rigid cast spout • Vandal resistant lever handles • Red/blue indicators • No lift rod hole • Vandal resistant aerator • 1.5 gpm @ 60 psi, 5.7 L/min @ 414 kPa • CER-TECK® cartridges
23C333	3	262.90	Chrome	
	Commercial <i>Widespread Lavatory Faucet</i>			<ul style="list-style-type: none"> • 3-hole 6"-12" installation • 4 1/2" long rigid cast spout • Vandal resistant sanitary hood blade handles • Red/blue indicators • No lift rod hole • Vandal resistant aerator • 1.5 gpm @ 60 psi, 5.7 L/min @ 414 kPa • CER-TECK® cartridges
23C334	1	282.10	Chrome	



Model Case Price Finish

Commercial
Widespread Lavatory Faucet

23C632	1	246.00	Chrome
23C642	1	242.40	Chrome

For complete 23C series product offering, see page C108.

Features

- 3-hole 6"-12" installation
- Rigid/swivel gooseneck spout
- 4 1/2" long, 12" high spout
- Vandal resistant hooded blade handles
- Red/blue indicators
- 23C632 - Vandal resistant aerator
- 23C642 - Standard aerator
- 1.5 gpm @ 60 psi, 5.7 L/min @ 414 kPa
- CER-TECK® cartridges



Commercial
Widespread Lavatory Faucet

23C643	3	241.10	Chrome
--------	---	--------	--------

- 3-hole 6"-12" installation
- Rigid/swivel gooseneck spout
- 4 1/2" long, 12" high spout
- Vandal resistant lever handles
- Red/blue indicators
- Standard aerator
- 1.5 gpm @ 60 psi, 5.7 L/min @ 414 kPa
- CER-TECK® cartridges



Commercial
Widespread Lavatory Faucet

23C624	1	273.20	Chrome
23C634	1	263.90	Chrome
23C644	3	260.30	Chrome

- 3-hole 6"-12" installation
- Rigid/swivel gooseneck spout
- 4 1/2" long, 12" high spout
- Vandal resistant sanitary hood blade handles
- Red/blue indicators
- 23C624 - Vandal resistant laminar outlet w/ Agion® Antimicrobial
- 23C634 - Vandal resistant aerator
- 23C644 - Standard aerator
- 1.5 gpm @ 60 psi, 5.7 L/min @ 414 kPa
- CER-TECK® cartridges



Model Case Price Finish Features



Commercial
Widespread Lavatory Faucet

3579LF-WFHDF 6 298.20 Chrome

- 3-hole 6"-16" installation
- Solid brass fabricated end valves and spout body
- 5 3/4" long, 11" high rigid spout
- 6 1/8" from deck to aerator
- Red/blue indicators
- 1 1/8" max. deck thickness
- Brass stems/stainless steel plate
- Grid strainer
- Laminar flow outlet
- 1/4 turn handle stops
- WF =1/2" IPS adapters
- 1.5 gpm @ 60 psi, 5.7 L/min @ 414 kPa
- Converts from 1.5 to 1.2 gpm by July 1, 2016

















Commercial
Widespread Lavatory Faucet

3579LF-WFLGHDF 6 278.95 Chrome

- 3-hole 6"-16" installation
- Solid brass fabricated end valves and spout body
- 5 3/4" long, 11" high rigid spout
- 6 1/8" from deck to aerator
- Red/blue indicators
- 1 1/8" max. deck thickness
- Brass stems/stainless steel plate
- Less grid strainer
- Laminar flow outlet
- 1/4 turn handle stops
- WF =1/2" IPS adapters
- 1.5 gpm @ 60 psi, 5.7 L/min @ 414 kPa
- Converts from 1.5 to 1.2 gpm by July 1, 2016



	Model	Case	Price	Finish	Features
	Commercial <i>Single Handle Bar/Prep Sink Faucet</i>				<ul style="list-style-type: none"> • 2-hole installation • 5 7/32" long, 10 11/64" high rigid spout • 6 5/32" from deck to aerator • Vandal resistant elbow handle • Red/blue indicators • Adjustable handle limit stop • 2 1/2" max. deck thickness • Vandal resistant outlet • 3/8" OD straight, staggered copper supply tubes with 3/8" fittings • 1.5 gpm @ 60 psi, 5.7 L/min @ 414 kPa • DIAMOND™ Valve
	710LF-HDF	6	230.20	Chrome	
					
	Commercial <i>Single Handle Bar/Prep Sink Faucet</i>				<ul style="list-style-type: none"> • 2-hole installation • Gooseneck spout swings 180° • 5 7/32" long, 10 11/64" high spout • 6 5/32" from deck to aerator • Vandal resistant elbow handle • Red/blue indicators • Adjustable handle limit stop • 2 1/2" max. deck thickness • Vandal resistant outlet • 3/8" OD straight, staggered copper supply tubes with 3/8" fittings • 1.5 gpm @ 60 psi, 5.7 L/min @ 414 kPa • DIAMOND™ Valve
	711LF-HDF	6	243.20	Chrome	
					
	Commercial <i>Single Handle Basin Faucet</i>				<ul style="list-style-type: none"> • 1-hole installation • 4" long spout swings 360° • 2 1/4" from deck to aerator • Vandal resistant lever handle • Red/blue indicator • Adjustable handle limit stop • 1 9/16" max. deck thickness • Vandal resistant aerator • Straight, staggered supply tubes with 1/2" IPS adapters • Order RP9633 for 6" spout • Order RP63131 for 8" spout • 1.5 gpm @ 60 psi, 5.7 L/min @ 414 kPa • Stainless steel ball
	570LF-WFHDF	6	157.70	Chrome	
					
	Commercial <i>Single Handle Basin Faucet</i>				<ul style="list-style-type: none"> • 1-hole installation • 6" long spout swings 360° • 3 1/2" from deck to aerator • Vandal resistant elbow handle • Red/blue indicators • Adjustable handle limit stop • 1 9/16" max. deck thickness • Vandal resistant aerator • Straight, staggered supply tubes with 1/2" IPS adapters • Order RP63131 for 8" spout • 1.5 gpm @ 60 psi, 5.7 L/min @ 414 kPa • Stainless steel ball
	570LF-06ELH	6	158.80	Chrome	
					

	Model	Case	Price	Finish	Features	
  	Commercial <i>Single Handle Metering Faucet</i>				<ul style="list-style-type: none"> • 1-hole installation • 4 1/4" long rigid spout • 1 1/2" from deck to aerator • Vandal resistant handle • Metering, slow-close push style • 1 1/8" max. deck thickness • Vandal resistant spray outlet - see (1) below • 1/2" threaded male inlet shank 	
  	Commercial <i>Two Handle Metering Faucet</i>	701LF-HDF	6	130.75	Chrome	<ul style="list-style-type: none"> • 2 or 3-hole 4" installation • 5" long spout • 1 7/8" from deck to aerator • Vandal resistant handles • Metering, slow-close push style • 1 3/8" max. deck thickness • No lift rod hole • Vandal resistant spray outlet - see (1) below • 1/2" IPS shanks
  	Commercial <i>Two Handle Metering Faucet</i>	2507LF-HDF	6	228.40	Chrome	<ul style="list-style-type: none"> • 2 or 3-hole 4" installation • 5" long spout • Vandal resistant handles • Metering, slow-close push style • 1 3/8" max. deck thickness • Grid strainer • No lift rod hole • Vandal resistant spray outlet - see (1) below • 1/2" IPS shanks
  	Commercial <i>Single Handle Metering Faucet</i>	87T104 87T110	6 6	137.90 169.20	Chrome Chrome	<ul style="list-style-type: none"> • 1-hole installation • Cast brass body • 5 2/5" long spout • Vandal resistant push button • Metering, slow-close push style • 2 1/2" max. deck thickness • 87T104 - Single inlet • 87T110 - Mixing tee and checks • Vandal resistant spray outlet - see (1) below

For complete 87T series product offering, see page C123.

(1) All Delta® metering, slow-close faucets have a 0.5 gpm (1.9L/min) flow control vandal resistant spray outlet. It delivers no more than 1/4 gallon per activation when not held open manually.

Model Case Price Finish Features



Commercial
Single Handle Metering Faucet

87T105	6	147.50	Chrome
87T111	6	179.45	Chrome

For complete 87T series product offering, see page C123.

- 1-hole installation
- Cast brass body
- 5 2/5" long spout
- Vandal resistant ADA lever handles
- Metering, slow-close lever style
- 2 1/2" max. deck thickness
- 87T105 - Single inlet
- 87T111 - Mixing tee and checks
- Vandal resistant spray outlet - See (1) below



Commercial
Two Handle Metering Faucet

86T1153	6	250.60	Chrome
---------	---	--------	--------

For complete 86T series product offering, see page C123.

- 2-hole 4" installation
- Cast brass body
- 5 1/10" long spout
- Vandal resistant ADA lever handles
- Metering, slow-close lever style
- Red/blue indicators
- 2 3/8" max. deck thickness
- No lift rod hole
- Vandal resistant spray outlet - See (1) below



Commercial
Centerset Coverplate

87T151	12	41.70	Chrome
--------	----	-------	--------

- 4" centerset cover plate
- Cast brass
- Two hold-down shanks
- For 87T series
- Vandal resistant

(1) All Delta® metering, slow-close faucets have a 0.5 gpm (1.9L/min) flow control vandal resistant spray outlet. It delivers no more than 1/4 gallon per activation when not held open manually.

NEW!



Model Case Price Finish Features

Commercial
Ara® Proximity® Deckmount Lavatory Faucet

630TP320	3	583.30	Chrome
631TP320	3	583.30	Chrome
630TP320-SS	3	643.30	Brilliance® Stainless

For complete 630TP series product offering, see pages C145–C146.

- 1-hole installation
- Cast brass spout
- 5 1/3" long, 5 1/2" high
- Hands-free activation
- Entire spout is sensor
- Adjustable sensing range, auto shut-off, metering mode, and periodic rinse feature
- Anti-rotation pin
- Surface mounted control box
- Mixing valve required
- 2 1/2" max. deck thickness
- Vandal resistant laminar outlet
- Order 061305A for 4" optional cover plate
- 630TP320 - Hardwire, order transformer separately
- 631TP320 - Battery operated, batteries included
- 1.5 gpm @ 60 psi, 5.7 L/min @ 414 kPa

NEW!



Commercial
Ara® Proximity® Deckmount Lavatory Faucet Trim

630TP358TR	3	318.50	Chrome
------------	---	--------	--------

- 1-hole installation
- Cast brass spout
- Trim Only
- Requires separate order of ELVAT0008ARI for complete product
- 5 1/3" long, 5 1/2" high
- Hands-free activation
- Entire spout is sensor
- Adjustable sensing range, auto shut-off, metering mode, and periodic rinse feature
- Anti-rotation pin
- 2 1/2" max. deck thickness
- Vandal resistant laminar outlet
- Order 061305A for 4" optional cover plate
- Hardwire, order transformer separately
- .5 gpm @ 60 psi, 1.9 L/min @ 414 kPa



Commercial
Arzo® Proximity® Deckmount Lavatory Faucet

600T040	3	583.30	Chrome
600T040-SS	3	640.00	Brilliance® Stainless
600T040-BB	3	627.65	Chrome
601T040	3	583.30	Chrome
601T040-SS	3	640.00	Brilliance® Stainless
600T040-BB-SS	1	684.35	Brilliance® Stainless

For complete 600T series product offering, see page C142.

- 1-hole installation
- Cast brass spout
- 4 11/25" long, 4 9/10" high
- Hands-free activation
- Entire spout is sensor
- Adjustable sensing range, auto shut-off, metering mode, and periodic rinse feature
- Surface mounted control box
- Mixing valve required
- 1 1/2" max. deck thickness
- Order 062021A for 4" or 061119A for 8" optional cover plate
- 600T040 - Hardwire, order transformer separately
- 600T040-BB - Hardwire with battery back-up, order transformer separately
- 601T040 - Battery operated, batteries included
- 1.5 gpm @ 60 psi, 5.7 L/min @ 414 kPa



Model Case Price Finish

Commercial
Arzo® Proximity® Deckmount Lavatory Faucet

600T050	3	591.95	Chrome
600T050-SS	3	648.65	Brilliance® Stainless
601T050	3	591.95	Chrome
601T050-SS	3	648.65	Brilliance® Stainless

For complete 600T series product offering, see page C142.

Features

- 1-hole installation
- Cast brass spout
- 4 11/25" long, 4 9/10" high
- Hands-free activation
- Entire spout is sensor
- Adjustable sensing range, auto shut-off, metering mode, and periodic rinse feature
- Surface mounted control box
- Mixing valve required
- 1 1/2" max. deck thickness
- Order 062021A for 4" or 061119A for 8" optional cover plate
- 600T050 - Hardwire, order transformer separately
- 601T050 - Battery operated, batteries included
- 5 gpm @ 60 psi, 1.9 L/min @ 414 kPa



Commercial
Proximity® Deckmount Lavatory Faucet

620TP3320	3	582.50	Chrome
620TP3320-SS	3	642.50	Brilliance® Stainless
620TP3320-BB	3	626.85	Chrome
620TP3320-BB-SS	3	686.85	Brilliance® Stainless

For complete 620TP series product offering, see pages C143– C144.

- 1-hole installation
- Gooseneck spout
- 4 4/5" long, 9 3/5" high
- Hands-free activation
- Entire spout is sensor
- Adjustable sensing range, auto shut-off, metering mode, and periodic rinse feature
- Surface mounted control box
- Mixing valve required
- 2 1/2" max. deck thickness
- Vandal resistant laminar outlet
- Order 061269A for 4" optional cover plate
- 620TP3320 - Hardwire, order transformer separately
- 620TP3320-BB - Hardwire with battery back-up, order transformer separately
- 1.5 gpm @ 60 psi, 5.7 L/min @ 414 kPa



Commercial
Proximity® Deckmount Lavatory Faucet Trim

620TP3321TR	3	326.80	Chrome
620TP3321TR-SS	3	386.80	Brilliance® Stainless
620TP3321TR-BB	3	371.15	Chrome
620TP3321TR-BB-SS	3	431.15	Brilliance® Stainless

- 1-hole installation
- Gooseneck spout
- Trim only
- Requires separate order of ELAVT0001ARI for complete product
- 4 4/5" long, 9 3/5" high
- Hands-free activation
- Entire spout is sensor
- Adjustable sensing range, auto shut-off, metering mode, and periodic rinse feature
- Mixing valve required
- 2 1/2" max. deck thickness
- Vandal resistant laminar outlet
- Order 061269A for 4" optional cover plate
- 620TP3321TR - Hardwire, order transformer separately
- 620TP3321TR-BB - Hardwire with battery back-up, order transformer separately
- 1.5 gpm @ 60 psi, 5.7 L/min @ 414 kPa



Model	Case	Price	Finish	Features
-------	------	-------	--------	----------



Commercial
Proximity® Deckmount Lavatory Faucet Trim

621TP3321TR	3	326.80	Chrome
621TP3321TR-SS	3	386.80	Brilliance® Stainless

For complete 620TP series product offering, see pages C143–C144.

- 1-hole installation
- Gooseneck spout
- Trim only
- Requires separate order of ELAVT0001ARI for complete product
- 4 4/5" long, 9 3/5" high
- Hands-free activation
- Entire spout is sensor
- Adjustable sensing range, auto shut-off, metering mode, and periodic rinse feature
- Mixing valve required
- 2 1/2" max. deck thickness
- Vandal resistant laminar outlet
- Order 061269A for 4" optional cover plate
- Battery operated
- Batteries included
- 1.5 gpm @ 60 psi, 5.7 L/min @ 414 kPa



Commercial
Proximity® Deckmount Lavatory Faucet Trim

621TP3358TR	3	318.50	Chrome
-------------	---	--------	--------

- 1-hole installation
- Gooseneck spout
- Trim only
- Requires separate order of ELAVT0008ARI for complete product
- 4 4/5" long, 9 5/8" high
- Hands-free activation
- Entire spout is sensor
- Adjustable sensing range, auto shut-off, metering mode, and periodic rinse feature
- 2 1/2" max. deck thickness
- Vandal resistant laminar outlet
- Order 061269A for 4" optional cover plate
- Battery operated
- Batteries included
- .5 gpm @ 60 psi, 1.9 L/min @ 414 kPa



Commercial
Proximity® Deckmount Lavatory Faucet

590TP0120	3	582.50	Chrome
590TP1120	3	582.50	Chrome

For complete 590TP series product offering, see pages C136–C137.

- 1-hole installation
- Cast body
- 5" long cast hi-rise spout
- Hands-free activation
- Entire spout is sensor
- Adjustable sensing range, auto shut-off, metering mode, and periodic rinse feature
- Surface mounted control box
- Recessed control box options available
- Mixing valve required
- 3" max. deck thickness
- Vandal resistant laminar outlet w/ Agion® Antimicrobial
- 590TP0120 - Hardwire, order transformer separately
- 590TP1120 - Battery operated, batteries included
- 1.5 gpm @ 60 psi, 5.7 L/min @ 414 kPa



Model	Case	Price	Finish	Features
-------	------	-------	--------	----------



Commercial
Proximity® Deckmount Lavatory Faucet Trim

590TP0128TR 1 318.50 Chrome

For complete 590TP series product offering, see pages C136–C137.

- 1-hole installation
- Trim only
- Requires separate order of ELAVT0008ARI for complete product
- 5" long cast hi-rise spout
- Hands-free activation
- Entire spout is sensor
- Adjustable sensing range, auto shut-off, metering mode, and periodic rinse feature
- Surface or recessed mount control box options
- 3" max. deck thickness
- Vandal resistant laminar outlet w/ Agion® Antimicrobial
- Hardwire, order transformer separately
- 1.5 gpm @ 60 psi, 5.7 L/min @ 414 kPa



Commercial
Proximity® Deckmount Lavatory Faucet Trim

590TP0158TR 1 318.50 Chrome

- 1-hole installation
- Trim only
- Requires separate order of ELAVT0008ARI for complete product
- 5" long cast hi-rise spout
- Hands-free activation
- Entire spout is sensor
- Adjustable sensing range, auto shut-off, metering mode, and periodic rinse feature
- Surface or recessed mount control box options
- 3" max. deck thickness
- Vandal resistant laminar outlet
- Hardwire, order transformer separately
- .5 gpm @ 60 psi, 1.9 L/min @ 414 kPa



Commercial
Proximity® Deckmount Lavatory Faucet Trim

590TP0258TR 3 385.55 Chrome

- 1 or 3-hole installation (4" coverplate included)
- Trim only
- Requires separate order of ELAVT0008ARI for complete product
- 5" long cast hi-rise spout
- Hands-free activation
- Entire spout is sensor
- Adjustable sensing range, auto shut-off, metering mode, and periodic rinse feature
- Surface or recessed mount control box options
- 2.5" max. deck thickness
- Vandal resistant laminar outlet
- Hardwire, order transformer separately
- .5 gpm @ 60 psi, 1.9 L/min @ 414 kPa



Commercial
Proximity® Deckmount Lavatory Faucet

591TP0250 6 582.50 Chrome

For complete 591TP series product offering, see pages C140–C141.

- 3-hole 4" installation
- Cast body
- 5" long spout
- 4 7/10" from deck to aerator
- Hands-free activation
- Entire spout is sensor
- Adjustable sensing range, auto shut-off, metering mode, and periodic rinse feature
- Surface mounted control box
- Recessed mount control box option available
- 2.5" max. deck thickness
- Mixing valve required
- Vandal resistant laminar outlet
- Hardwire, order transformer separately
- .5 gpm @ 60 psi, 1.9 L/min @ 414 kPa



Model	Case	Price	Finish	Features
-------	------	-------	--------	----------



Commercial
Proximity® Deckmount Lavatory Faucet

591TP1250	6	582.50	Chrome
-----------	---	--------	--------

For complete 591TP series product offering, see pages C140–C141.

- 3-hole 4" installation
- Cast body
- 5" long spout
- 4 7/10" from deck to aerator
- Hands-free activation
- Entire spout is sensor
- Adjustable sensing range, auto shut-off, metering mode, and periodic rinse feature
- Surface mounted control box
- Recessed mount control box option available
- Mixing valve required
- 2.5" max. deck thickness
- Vandal resistant laminar outlet
- Battery operated
- Batteries included
- .5 gpm @ 60 psi, 1.9 L/min @ 414 kPa



Commercial
Proximity® Deckmount Lavatory Faucet Trim

591TP0268TR	1	309.80	Chrome
-------------	---	--------	--------

- 3-hole 4" installation
- Trim only
- Requires separate order of ELAVT0008ARI for complete product
- Cast body
- 5" long spout
- 4 7/10" from deck to aerator
- Hands-free activation
- Entire spout is sensor
- Adjustable sensing range, auto shut-off, metering mode, and periodic rinse feature
- Surface or recessed mount control box options
- 2.5" max. deck thickness
- Vandal resistant laminar outlet
- Hardwire, order transformer separately
- 1.0 gpm @ 60 psi, 3.8 L/min @ 414 kPa



Commercial
Proximity® Deckmount Lavatory Faucet

590-PLGHDF	3	452.65	Chrome
590-PLGHDFHW	3	452.65	Chrome

- 1-hole installation
- 5 3/10" long spout
- 3 1/5" from deck to aerator
- Hands-free activation
- Entire spout is sensor
- Adjustable sensing range, auto shut-off, metering mode, and periodic rinse feature
- Surface mounted control box
- Mixing valve required
- 2" max. deck thickness
- Vandal resistant laminar outlet
- No lift rod hole
- 590-PLGHDF - Battery operated, batteries included
- Audible low battery indicator
- 590-PLGHDFHW - Hardwire, order transformer separately
- .5 gpm @ 60 psi, 1.9 L/min @ 414 kPa





Model Case Price Finish

Commercial
Proximity® Deckmount Lavatory Faucet

591-PLGHDF	3	472.65	Chrome
591-PLGHDFHW	3	472.65	Chrome

Features

- 3-hole 4" installation
- 5 3/10" long spout
- 3 9/10" from deck to aerator
- Hands-free activation
- Entire spout is sensor
- Adjustable sensing range, auto shut-off, metering mode, and periodic rinse feature
- Surface mounted control box
- Mixing valve required
- 2" max. deck thickness
- Vandal resistant laminar outlet
- No lift rod hole
- 4" Anti-rotation cover plate
- 591-PLGHDF - Battery operated, batteries included
- Audible low battery indicator
- 591-PLGHDFHW - Hardwire, order transformer separately
- .5 gpm @ 60 psi, 1.9 L/min @ 414 kPa



Commercial
Proximity® Deckmount Lavatory Faucet

592-PLGHDF	3	497.15	Chrome
592-PLGHDFHW	3	497.15	Chrome

- 3-hole 8" installation
- 5 3/10" long spout
- 3 9/10" from deck to aerator
- Hands-free activation
- Entire spout is sensor
- Adjustable sensing range, auto shut-off, metering mode, and periodic rinse feature
- Surface mounted control box
- Mixing valve required
- 2" max. deck thickness
- Vandal resistant laminar outlet
- No lift rod hole
- 8" Anti-rotation cover plate
- 592-PLGHDF - Battery operated, batteries included
- Audible low battery indicator
- 592-PLGHDFHW - Hardwire, order transformer separately
- .5 gpm @ 60 psi, 1.9 L/min @ 414 kPa

Model	Case	Price	Finish	Features
-------	------	-------	--------	----------



Commercial
Electronic Lavatory Faucet

DEMD-101LF	6	611.40	Chrome
DEMD-101LF-NS	6	718.40	Nickel Stainless

- 1-hole installation
- Above deck solenoid and battery
- For cold or premixed water
- Vandal resistant wrench flat spray outlet
- 1 1/2" max. deck thickness
- Battery operated
- Batteries included
- .5 gpm @ 60 psi, 1.9 L/min @ 414 kPa



Commercial
Electronic Lavatory Faucet

DEMD-111LF	6	649.60	Chrome
DEMD-111LF-NS	6	763.30	Nickel Stainless

- 1-hole installation
- Above deck solenoid and battery
- Side mixer
- Red/blue indicator
- Vandal resistant wrench flat spray outlet
- 1 1/2" max. deck thickness
- Battery operated
- Batteries included
- .5 gpm @ 60 psi, 1.9 L/min @ 414 kPa



Commercial
Electronic Lavatory Faucet

DEMD-112LF	6	649.60	Chrome
------------	---	--------	--------

- 1-hole installation
- Above deck solenoid and battery
- Side technicians mixer
- Temperature set and adjusted with Allen key (included)
- Vandal resistant wrench flat spray outlet
- 1 1/2" max. deck thickness
- Battery operated
- Batteries included
- .5 gpm @ 60 psi, 1.9 L/min @ 414 kPa



Model	Case	Price	Finish	Features
-------	------	-------	--------	----------



Commercial
Electronic Lavatory Faucet

DEMD-201LF	6	655.05	Chrome
DEMD-201LF-NS	6	769.70	Nickel Stainless

- 1-hole installation
- Above deck electronics
- For cold or premixed water
- Vandal resistant wrench flat spray outlet
- 1 1/4" max. deck thickness
- Battery operated
- Batteries included
- .5 gpm @ 60 psi, 1.9 L/min @ 414 kPa



Commercial
Electronic Lavatory Faucet

DEMD-211LF	6	693.25	Chrome
DEMD-211LF-NS	6	814.60	Nickel Stainless

- 1-hole installation
- Above deck electronics
- Side mixer
- Red/blue indicator
- Vandal resistant wrench flat spray outlet
- 1 1/4" max. deck thickness
- Battery operated
- Batteries included
- .5 gpm @ 60 psi, 1.9 L/min @ 414 kPa



Commercial
Electronic Lavatory Faucet

DEMD-212LF	6	693.25	Chrome
------------	---	--------	--------

- 1-hole installation
- Above deck electronics
- Side technicians mixer
- Temperature set and adjusted with Allen key (included)
- Vandal resistant wrench flat spray outlet
- 1 1/4" max. deck thickness
- Battery operated
- Batteries included
- .5 gpm @ 60 psi, 1.9 L/min @ 414 kPa



Model	Case	Price	Finish	Features
-------	------	-------	--------	----------



Commercial
Electronic Lavatory Faucet

DEMD-301LF	6	604.60	Chrome
DEMD-301LF-NS	6	710.35	Nickel Stainless

- 1-hole installation
- For cold or premixed water
- Vandal resistant wrench flat spray outlet
- 2" max. deck thickness
- Battery operated
- Batteries included
- .5 gpm @ 60 psi, 1.9 L/min @ 414 kPa



Commercial
Electronic Lavatory Faucet

DEMD-311LF	6	644.10	Chrome
DEMD-311LF-NS	6	756.80	Nickel Stainless

- 1-hole installation
- Side mixer
- Red/blue indicators
- Vandal resistant wrench flat spray outlet
- 2" max. deck thickness
- Battery operated
- Batteries included
- .5 gpm @ 60 psi, 1.9 L/min @ 414 kPa



Commercial
Electronic Lavatory Faucet

DEMD-312LF	6	644.10	Chrome
------------	---	--------	--------

- 1-hole installation
- Side technicians mixer
- Temperature set and adjusted with adjusting lever (included)
- Vandal resistant wrench flat spray outlet
- 2" max. deck thickness
- Battery operated
- Batteries included
- .5 gpm @ 60 psi, 1.9 L/min @ 414 kPa



	Model	Case	Price	Finish	Features
	Commercial <i>Electronic Wall Mount Lavatory Faucet</i>				<ul style="list-style-type: none"> • 1-hole wall mount installation • 8" Spout • For cold or premixed water • Hardwire, order transformer separately • Hardwire 24 VAC to 9 VDC converter supplied • .5 gpm @ 60 psi, 1.9 L/min @ 414 kPa
	DEMD-402LF	6	800.40	Chrome	
	DEMD-402LF-NS	6	940.45	Nickel Stainless	
	  				
	Commercial <i>Electronic Wall Mount Lavatory Faucet</i>				<ul style="list-style-type: none"> • 1-hole wall mount installation • 6" Spout • For cold or premixed water • Hardwire, order transformer separately • Hardwire 24 VAC to 9 VDC converter supplied • .5 gpm @ 60 psi, 1.9 L/min @ 414 kPa
	DEMD-404LF	6	765.30	Chrome	
	DEMD-404LF-NS	6	899.25	Nickel Stainless	
	  				
NEW! 	Commercial <i>ASSE 1070 Lavatory Faucet</i>				<ul style="list-style-type: none"> • 1-hole installation • ASSE 1070 thermostatic electronic metering faucet with above deck electronics • Integrated thermostatic mixing valve • Integrated solenoid • Mixing handle adjusts temperature • Anti-rotation pin • 1 4/5" max. deck thickness • Vandal resistant wrench flat spray outlet • Order 060585A for optional 4" cover plate • Adjustable comfort limit stop • Battery operated • Batteries included • DEMD-611-10LF - .25 gal/cycle @ 60 psi, .95 L/cycle @ 414 kPa based on 15 second max. run time • DEMD-611LF - .17 gal/cycle @ 60 psi, .64 L/cycle @ 414 kPa based on 15 second max. run time
	DEMD-611LF	4	785.30	Chrome	
	DEMD-611-10LF	4	785.30	Chrome	
	  				



Model	Case	Price	Finish	Features
Commercial <i>Electronic Soap Dispenser</i>				
DESD-250	1	287.70	Chrome	<ul style="list-style-type: none"> • 1-hole installation • Deck mount electronic hand soap dispenser • Non-metal spout • 800 ml lotion hand soap with moisturizer included • Battery operated • Batteries included • 2" max. deck thickness • 3-year warranty



Commercial <i>Electronic Soap Dispenser</i>				
DESD-550	3	441.55	Chrome	<ul style="list-style-type: none"> • 1-hole installation • Deck mount electronic hand soap dispenser • Cast brass spout • 800 ml lotion hand soap with moisturizer included • Battery operated • Batteries included • 2" max. deck thickness





Commercial <i>Hand Soap with Moisturizer</i>				
060917A	4•	36.30	NA	<ul style="list-style-type: none"> • 1600 ml antibacterial hand soap • Hand soap w/moisturizer

















Commercial <i>Soap Dispenser Plug-in Transformer</i>				
060918A	1	68.05	NA	<ul style="list-style-type: none"> • Plug-in transformer to convert DESD-250 or DESD-550 to hardwire • 120 VAC to 6 VDC • 060919A not required if this transformer is used



Commercial <i>Soap Dispenser Converter</i>				
060919A	1	61.15	NA	<ul style="list-style-type: none"> • Hardwire converter to convert DESD-250 or DESD-550 to hardwire • 24 VAC to 6 VDC • Transformer required (order separately)

	Model	Case	Price	Finish	Features
	Commercial <i>DEMD Transformer</i>				<ul style="list-style-type: none"> • Plug in transformer ONLY for DEMD faucet models • 120 VAC to 9 VDC • No converter required • For hardwire conversions, see specification sheets
	060958A	1	44.05	NA	
	Commercial <i>DEMD Remote</i>				<ul style="list-style-type: none"> • Remote control ONLY for DEMD faucet models
	060967A	1	237.55	NA	
	Commercial <i>DEMD Converter</i>				<ul style="list-style-type: none"> • Hardwire converter ONLY for DEMD faucet models • 24 VAC to 9 VDC • Transformer required (order separately) • For hardwire conversions, see specification sheets
	060974A	1	62.90	NA	

	Model	Case	Price	Finish	Features
NEW! 	Commercial <i>4" Center Cover Plate</i>				<ul style="list-style-type: none"> • 4" center cover plate • Anti-rotation pin • For use with 620TP, 621TP series
	061269A	1	64.30	Chrome	
	061269SS	1	77.15	Brilliance® Stainless	
NEW! 	Commercial <i>4" Center Cover Plate</i>				<ul style="list-style-type: none"> • 4" centerset cover plate • Anti-rotation pin • For use with 630TP, 631TP Series
	061305A	1	76.55	Chrome	
	061305SS	1	83.90	Brilliance® Stainless	
	Commercial Accessories <i>Arzo® 4" Cover Plate</i>				<ul style="list-style-type: none"> • 4" centerset cover plate • For Arzo® Proximity® sensing lavatory faucet • Reduces max. deck thickness to 1 1/8"
062021A	1	20.05	Chrome		
	Commercial <i>4" Center Cover Plate</i>				<ul style="list-style-type: none"> • 4" center cover plate with locking pin • Anti-rotation (2 1/2" x 7") • For use with 590 HDF series
RP30528	1	87.25	Chrome		
	Commercial <i>8" Center Cover Plate</i>				<ul style="list-style-type: none"> • 8" center cover plate with locking pin • Anti rotation (2 1/2" x 11") • For use with 590 HDF series
RP34280	1	117.00	Chrome		

	Model	Case	Price	Finish	Features
   	Commercial <i>H₂Optics</i> [®] Lavatory Faucet	6	423.85	Chrome	<ul style="list-style-type: none"> • 1-hole installation • All metal faucet construction • 5 1/4" long, 3 7/8" high rigid spout • 2 3/8" from deck to aerator • Hands-free activation • <i>H₂Optics</i>[®] Technology • Self-adaptive technology • Mixing valve required • 1" max. deck thickness • Vandal resistant laminar outlet • Less grid strainer • No lift rod hole • Battery operated • Batteries included • .5 gpm @ 60 psi, 1.9 L/min @ 414 kPa
   	Commercial <i>H₂Optics</i> [®] Lavatory Faucet	6	446.40	Chrome	<ul style="list-style-type: none"> • 1-hole installation • All metal faucet construction • 5 1/4" long, 3 7/8" high rigid spout • 2 3/8" from deck to aerator • Hands-free activation • <i>H₂Optics</i>[®] Technology • Self-adaptive technology • Mixing valve required • 1" max. deck thickness • Vandal resistant laminar outlet • Grid strainer • No lift rod hole • Battery operated • Batteries included • .5 gpm @ 60 psi, 1.9 L/min @ 414 kPa
   	Commercial <i>H₂Optics</i> [®] Lavatory Faucet	6	444.35	Chrome	<ul style="list-style-type: none"> • 3-hole 4" installation • All metal faucet construction • 5 1/4" long, 4 3/8" high rigid spout • 2 13/16" from deck to aerator • Hands-free activation • <i>H₂Optics</i>[®] Technology • Self-adaptive technology • Mixing valve required • 1 1/2" max. deck thickness • Vandal resistant laminar outlet • Less grid strainer • No lift rod hole • 4" Anti-rotation cover plate • Battery operated • Batteries included • .5 gpm @ 60 psi, 1.9 L/min @ 414 kPa
   	Commercial <i>H₂Optics</i> [®] Lavatory Faucet	6	466.80	Chrome	<ul style="list-style-type: none"> • 3-hole 4" installation • All metal faucet construction • 5 1/4" long, 4 3/8" high rigid spout • 2 13/16" from deck to aerator • Hands-free activation • <i>H₂Optics</i>[®] Technology • Self-adaptive technology • Mixing valve required • 1 1/2" max. deck thickness • Vandal resistant laminar outlet • Grid strainer • No lift rod hole • 4" Anti-rotation cover plate • Battery operated • Batteries included • .5 gpm @ 60 psi, 1.9 L/min @ 414 kPa



Model Case Price Finish

Commercial
H₂Optics[®] Lavatory Faucet

590T0120	3	541.10	Chrome
590T0120-BB	3	585.45	Chrome
590T1120	3	541.10	Chrome

For complete 590T series product offering, see pages C134–C135.

Features

- 1-hole installation
- Forged brass solenoid valve
- 5" long cast hi-rise spout
- Hands-free activation
- H₂Optics[®] Technology
- Adjustable sensing range, auto shut-off, metering mode, and periodic rinse feature
- Surface mounted control box
- Mixing valve required
- 1 1/2" max. deck thickness
- Vandal resistant laminar outlet w/ Agion[®] Antimicrobial
- 590T0120 - Hardwire, order transformer separately
- Recessed control box options available
- 590T0120-BB - Hardwire with battery backup, order transformer separately
- 590T1120 - Battery operated, batteries included
- 1.5 gpm @ 60 psi, 5.7 L/min @ 414 kPa



Commercial
H₂Optics[®] Lavatory Faucet

591T0250	6	541.10	Chrome
591T1250	6	541.10	Chrome

For complete 591T series product offering, see page C138–C139.

- 3-hole 4" installation
- Cast body
- 5" long cast spout
- Hands-free activation
- H₂Optics[®] Technology
- Adjustable sensing range, auto shut-off, metering mode, and periodic rinse feature
- Surface mounted control box
- Mixing valve required
- 2" max. deck thickness
- Vandal resistant laminar outlet
- 591T0250 - Hardwire, order transformer separately
- Recessed control box options available
- 591T1250 - Battery operated, batteries included
- .5 gpm @ 60 psi, 1.9 L/min @ 414 kPa



Commercial
Electronic Shower

860T167	1	1,272.65	Chrome
---------	---	----------	--------

For complete 860T series product offering, see page C147.

- Recessed metal box mount with pressure-balance mixing valve
- Electronic shower with push button activator
- Vandal resistant handle adjusts temperature
- Red/blue label on cover plate
- 30° vandal resistant cast shower head
- Hardwire, order transformer separately
- 1.5 gpm @ 80 psi, 5.7 L/min @ 550 kPa max. water usage



Commercial
Low Profile Institutional Electronic Shower

860T178	1	1,272.65	Chrome
---------	---	----------	--------

- Recessed metal box mount with thermostatic mixing valve
- Electronic shower with push button activator
- Tempered water supplied to solenoid valve
- Field adjustable shower time
- 30° vandal resistant forged shower head
- Hardwire
- Order transformer separately
- 1.5 gpm @ 80 psi, 5.7 L/min @ 550 kPa max. water usage





Model Case Price Finish

Commercial
H₂Optics[®] Deck Mount Faucet

1500T3320	1	628.25	Chrome
1501T3320	1	628.25	Chrome

For complete 1500T3 series product offering, see pages C149–C150.

Features

- 1-hole installation
- Cast brass body
- 6" long, 14 4/5" high rigid spout
- Hands-free activation
- *H₂Optics*[®] Technology
- Adjustable sensing range, auto shut-off, metering mode, and periodic rinse feature
- Surface mount box
- Mixing valve required
- 2.5" max. deck thickness
- Vandal resistant laminar outlet w/ Agion[®] Antimicrobial
- 1500T3320 - Hardwire, order transformer separately
- 1501T3320 - Battery operated, batteries included
- 1.5 gpm @ 60 psi, 5.7 L/min @ 414 kPa



Commercial
H₂Optics[®] Deck Mount Faucet Trim

1500T3428TR	1	379.75	Chrome
1501T3428TR	1	379.75	Chrome

- 3-hole 4" installation
- Trim Only
- Requires separate order of ELAVT0008ARI rough for complete product
- Cast brass body
- 6" long, 15 2/5" high rigid spout
- Hands-free activation
- *H₂Optics*[®] Technology
- Adjustable sensing range, auto shut-off, metering mode, and periodic rinse feature
- Recessed mount 10" x 10" box with thermostatic mixing valve
- 2.5" max. deck thickness
- Vandal resistant laminar outlet w/ Agion[®] Antimicrobial
- 4" cover plate
- 1500T3428TR - Hardwire, order transformer separately
- 1501T3428TR - Battery operated, batteries included
- 1.5 gpm @ 60 psi, 5.7 L/min @ 414 kPa



Commercial
H₂Optics[®] Deck Mount Faucet Trim

1500T3478TR	1	379.75	Chrome
1501T3478TR	1	379.75	Chrome

- 3-hole 4" installation
- Trim Only
- Requires separate order of ELAVT0008ARI rough for complete product
- Cast brass body
- 6" long, 15 2/5" high rigid spout
- Hands-free activation
- *H₂Optics*[®] Technology
- Adjustable sensing range, auto shut-off, metering mode, and periodic rinse feature
- Recessed mount 10" x 10" box with thermostatic mixing valve
- 2.5" max. deck thickness
- Smooth end spout with laminar flow control in base
- 4" cover plate
- 1500T3478TR - Hardwire, order transformer separately
- 1501T3478TR - Battery operated, batteries included
- 1.5 gpm @ 60 psi, 5.7 L/min @ 414 kPa



Model Case Price Finish Features



Commercial
H₂Optics[®] Wall Mount Faucet

1500T4670	1	680.65	Chrome
1500T4670-BB	1	725.00	Chrome
1501T4670	1	680.65	Chrome

For complete 1500T4 series product offering, see page C151.

- Wall mount installation
- Cast brass body
- 6" long, 16 1/4" high rigid spout
- Hands-free activation
- H₂Optics[®] Technology
- Adjustable sensing range, auto shut-off, metering mode, and periodic rinse feature
- Surface mount box
- Mixing valve required
- Smooth end spout with laminar flow control in base
- 1500T4670 - Hardwire, order transformer separately
- 1500T4670-BB - Hardwire with battery backup
- 1501T4670 - Battery operated, batteries included
- 1.5 gpm @ 60 psi, 5.7 L/min @ 414 kPa



Commercial
H₂Optics[®] Deck Mount Faucet

3000T3320A	1	782.65	Chrome
3000T3320A-BB	1	827.00	Chrome
3001T3320A	1	782.65	Chrome

For complete 3000T3 series product offering, see pages C152–C153.

- 1-hole installation
- Cast brass body
- 6" long, 14 4/5" high rigid spout
- Hands-free activation
- H₂Optics[®] Technology
- Water resistant field adjustable program controller with LCD screen
- Surface mount box
- Mixing valve required
- 2.5" max. deck thickness
- Vandal resistant laminar outlet w/ Agion[®] Antimicrobial
- 3000T3320A - Hardwire, order transformer separately
- 3001T3320A - Battery operated, batteries included
- 1.5 gpm @ 60 psi, 5.7 L/min @ 414 kPa



Commercial
H₂Optics[®] Deck Mount Faucet Trim

3000T3428ATR	1	512.15	Chrome
3001T3428ATR	1	512.15	Chrome

- 3-hole 4" installation
- Trim Only
- Requires separate order of ELAVT0008ARI rough for complete product
- Cast brass body
- 6" long, 15 2/5" high rigid spout
- Hands-free activation
- H₂Optics[®] Technology
- Water resistant field adjustable program controller with LCD screen
- 2.5" max. deck thickness
- Vandal resistant laminar outlet w/ Agion[®] Antimicrobial
- 4" cover plate
- 3000T3428ATR - Hardwire order transformer separately
- 3001T3428ATR - Battery operated, batteries included
- 1.5 gpm @ 60 psi, 5.7 L/min @ 414 kPa



Model	Case	Price	Finish	Features
-------	------	-------	--------	----------



Commercial
H₂Optics® Deck Mount Faucet Trim

3000T3478ATR	1	512.15	Chrome
3001T3478ATR	1	512.15	Chrome

For complete 3000T3 series product offering, see pages C152–C153.

- 3-hole 4" installation
- Trim Only
- Requires separate order of ELAVT0008ARI rough for complete product
- Cast brass body
- 6" long, 15 2/5" high rigid spout
- Hands-free activation
- H₂Optics® Technology
- 2.5" max. deck thickness
- Smooth end spout with laminar flow control in base
- 4" cover plate
- 3000T3478A - Hardwire, order transformer separately
- 3001T3478A - Battery operated, batteries included
- 1.5 gpm @ 60 psi, 5.7 L/min @ 414 kPa

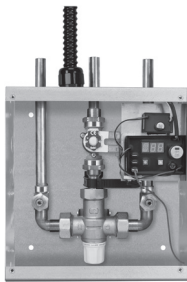

Commercial
Deckmount Lavatory Rough-in Valve

ELAVT0008ARI	1	633.25	NA
--------------	---	--------	----

- Rough-in only
- Below deck
- Recessed mount 10" x 10" box with thermostatic mixing valve

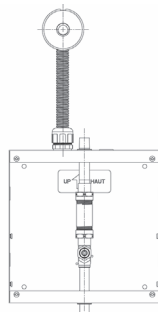

Commercial
Deckmount Lavatory Rough-in Valve

ELAVT0001ARI	1	417.75	NA
--------------	---	--------	----

- Rough-in only
- Below deck
- Recessed mount 10" x 10" box with single inlet supply



Commercial
Deck Mount Mixing Valve

24T3003	1	218.85	Chrome
---------	---	--------	--------

- Deck mount mixing valve for 1500T and 3000T series
- Valve supplies tempered water to below deck solenoid valve for #0 control box
- 3/8" compression connectors
- 1.5" max. deck thickness
- Stainless steel ball valve



Model	Case	Price	Finish	Features
-------	------	-------	--------	----------



Commercial
Low Profile Institutional Double Sensor Trim

3000T4128ATR	1	1,060.00	Chrome
--------------	---	----------	--------

For complete 3000T4 series product offering, see page C154.

- Trim only
- Requires separate order of 3000T4128ARI rough for complete product
- Hands-free activation
- H₂Optics® Technology
- 4.5" x 4.5" stainless steel wall plates with chrome plated rigid stub spout
- Laminar swivel outlet
- Field adjustable sensor range and meter mode retains settings in event of power failure
- Hardwire
- Order transformer separately
- 1.5 gpm @ 60 psi, 5.7 L/min @ 414 kPa

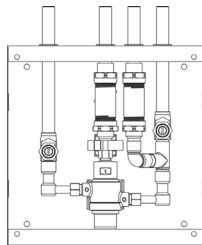

Commercial
Low Profile Institutional Double Sensor Rough

3000T4128ARI	1	660.00	NA
--------------	---	--------	----

- Rough-in only
- Requires separate order of 3000T4128ATR trim for complete product
- 10" x 10" metal box with thermostatic mixing valve
- 4" square boxes for sensor wall plates
- 4" square box for spout wall plate
- Integral check valves
- Max flow 5.8 gpm @ 45 psi, 22 L/min @ 310 kPa pressure loss
- Min flow .35 gpm, 1.3 L/min @ thermostatic mixing valve



Commercial
Low Profile Institutional Single Sensor Trim

3000T4328ATR	1	700.00	Chrome
--------------	---	--------	--------

- Trim only
- Requires separate order of 3000T4328ARI rough for complete product
- Hands-free activation
- H₂Optics® Technology
- 4.5" x 4.5" stainless steel wall plate with chrome plated rigid stub spout
- Laminar swivel outlet
- Field adjustable sensor range and meter mode retains settings in event of power failure
- Hardwire
- Order transformer separately
- 1.5 gpm @ 60 psi, 5.7 L/min @ 414 kPa

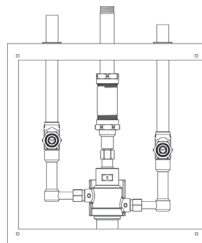





Commercial
Low Profile Institutional Single Sensor Rough

3000T4328ARI	1	600.00	Chrome
--------------	---	--------	--------

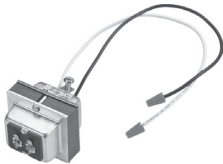
- Rough-in only
- Requires separate order of 3000T4328ATR trim for complete product
- 10" x 10" metal box with thermostatic mixing valve
- 4" square box for sensor wall plate
- 4" square box for spout wall plate
- Integral check valves
- Max flow 5.8 gpm @ 45 psi, 22 L/min @ 310 kPa pressure loss
- Min flow .35 gpm, 1.3 L/min @ thermostatic mixing valve

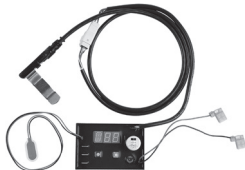

	Model	Case	Price	Finish	Features
	Commercial <i>Optional Hardwire Transformer</i>				<ul style="list-style-type: none"> • Hardwire transformer • Supplies power for up to 10 Delta 590-HDF electronic faucets converted to hardwire or for 10 - 860T or up to 5 - 3000T, 1500T, 590T, 590TP, 591T, 591TP, 600T, 620TP, 630TP, DEMD, 1600T, 81THWA & 81TWMS series
	RP32508	1	42.80	NA	<p>For additional transformers, see page C133.</p>
	Commercial <i>Plug-In Transformer</i>				<ul style="list-style-type: none"> • Plug-in transformer • Supplies power for up to 10 Delta 590-HDF electronic faucets converted to hardwire or for 10 - 860T or up to 5 - 3000T, 1500T, 590T, 590TP, 591T, 591TP, 600T, 620TP, 630TP, DEMD, 1600T, 81THWA & 81TWMS series
	RP32856	1	42.80	NA	
	Commercial <i>Hardwire Converter with Battery Back-Up</i>				<ul style="list-style-type: none"> • Hardwire converter with battery back-up • For use with series: 590T, 590TP, 590-PHDF, 590-HDF, 591T, 591TP, 600T, 620TP, 630TP, 860T, 1500T, 1600T, 3000T, 81THWA, & 81TWMS series
	061047A	1	108.25	NA	
	Commercial <i>Proximity[®] Upgrade/Conversion Kit</i>				<ul style="list-style-type: none"> • Proximity[®] Sensing Technology upgrade/conversion kit • Converts to latest Proximity Sensing Technology with metering mode and periodic rinse features • For use on 590-PHDF, 590TP, 591TP and 600T series
	061271A	1	318.20	NA	
	Commercial <i>Hardwire Converter</i>				<ul style="list-style-type: none"> • Hardwire converter • Converts 24 VAC to 6.4 VDC
	060683A	1	46.80	NA	

Model Case Price Finish Features



Commercial
Mechanical Mixer

R2910-MIXLF 24 65.00 NA

- Mechanical mixer
- 2.0 gpm @ 60psi, 7.6 L/min @ 414kPa



Commercial
Thermostatic Mixing Valve

R3070-MIXLF 24 134.95 NA

- Thermostatic mixing valve
- IAPMO listed to ASSE 1070
- 3/8" compression inlets/outlets
- Check valves on inlets
- Minimum 0.35 gpm (1.3 L/min) flow rate
- Maximum flow of 5.8 gpm (22 L/min) @ 45 psi pressure loss



Commercial
Thermostatic Mixing Valve

R2570-MIXLF 1 166.55 NA

- Thermostatic mixing valve
- IAPMO listed to ASSE 1069, ASSE 1070
- 1/2" copper sweat inlets/outlets
- Check valves on inlets
- Minimum 0.34 gpm (1.29 L/min) flow rate
- Maximum 11.0 gpm (42 L/min) flow rate



Model Case Price Finish Features



Commercial
Electronic Side Mount Flush Kit

DEFM-100 6 325.35 Chrome

- Electronic side mount flush kit for converting manual 81T Teck® flush valves and 86T metering urinals to electronic
- For Sloan®, Crane® and some Zurn® Models
- 3 year warranty
- Battery operated
- Batteries included



Commercial
Manual Water Closet Flush Valve w/ Electronic Flush Kit

81T201-DEFM 1 500.40 Chrome

- 81T201 manual water closet flush valve with DEFM-100 for conversion to electronic operation
- 1 1/2" top spud
- Battery operated
- Batteries included



Commercial
Manual Urinal Flush Valve w/ Electronic Flush Kit

81T231-DEFM 1 500.40 Chrome

- 81T231 manual urinal flush valve with DEFM-100 for conversion to electronic operation
- 3/4" top spud
- Battery operated
- Batteries included



NEW!



Commercial
H₂Optics® Exposed Flush Valve

81T201BTA-MMO 3 546.15 Chrome

For complete 81T series product offering, see pages C127–C131.

- Electronic exposed flush valve
- Hands-free operation
- Push-button mechanical override
- H₂Optics® Technology
- For 1 1/2" top inlet water closet fixture
- Body mounted sensor
- Battery operated
- Batteries included
- 1.6 gpf, 6 L/f Factory set flush, field adjustable



Model Case Price Finish Features



Commercial
H₂Optics[®] Exposed Flush Valve

81T201BTA	3	546.15	Chrome
81T201BTA-6	3	546.15	Chrome

For complete 81T series product offering, see pages C127–C131.

- Electronic exposed flush valve
- Hands-free operation
- H₂Optics[®] Technology
- For 1 1/2" top inlet water closet fixture
- Body mounted sensor
- Battery operated
- Batteries included
- 81T201BTA - 1.6 gpf, 6 L/f Factory set flush, field adjustable
- 81T201BTA-6 - 1.6 gpf, 6 L/f Factory set flush, NOT field adjustable



Commercial
H₂Optics[®] Exposed Flush Valve

81T201BTA-DF	3	546.15	Chrome
--------------	---	--------	--------

- Electronic exposed flush valve
- Hands-free activation
- H₂Optics[®] Technology
- For 1 1/2" top inlet water closet fixture
- Body mounted sensor
- DF models have dual flush settings factory set to ON, providing a 30% water reduced flush based on time and distance
- Battery operated
- Batteries included
- 1.6 gpf, 6 L/f Factory set flush, field adjustable



Commercial
H₂Optics[®] Exposed Flush Valve

81T201HWA	3	593.60	Chrome
81T201HWA-6	3	593.60	Chrome

- Electronic exposed flush valve
- Hands-free operation
- H₂Optics[®] Technology
- For 1 1/2" top inlet water closet fixture
- Body mounted sensor
- Hardwire, order transformer separately
- 81T201HWA - 1.6 gpf, 6 L/f Factory set flush, field adjustable
- 81T201HWA-6 - 1.6 gpf, 6 L/f Factory set flush, NOT field adjustable



NEW!



Commercial
H₂Optics[®] Exposed Flush Valve

81T231BTA-MMO	3	546.15	Chrome
---------------	---	--------	--------

- Electronic exposed flush valve
- Hands-free operation
- Push-button mechanical override
- H₂Optics[®] Technology
- For 3/4" top inlet urinal fixture
- Body mounted sensor
- Battery operated
- Batteries included
- 0.5 gpf, 1.9 L/f Factory set flush, field adjustable





Model Case Price Finish

Commercial
H₂Optics[®] Exposed Flush Valve

81T231BTA 3 546.15 Chrome

For complete 81T series product offering, see pages C127–C131.

Features

- Electronic exposed flush valve
- H₂Optics[®] Technology
- For 3/4" top inlet urinal fixture
- Body mounted sensor
- Battery operated
- Batteries included
- 0.5 gpf, 1.9 L/f Factory set flush, field adjustable



Commercial
H₂Optics[®] Exposed Flush Valve

81T231BTA-19 3 546.15 Chrome

- Electronic exposed flush valve
- H₂Optics[®] Technology
- For 3/4" top inlet urinal fixture
- Body mounted sensor
- Battery operated
- Batteries included
- 0.5 gpf, 1.9 L/f Factory set flush, NOT field adjustable



Commercial
H₂Optics[®] Exposed Flush Valve

81T231HWA 3 593.60 Chrome

- Electronic exposed flush valve
- Hands-free activation
- H₂Optics[®] Technology
- For 3/4" top inlet urinal fixture
- Body mounted sensor
- Hardwire, order transformer separately
- 0.5 gpf, 1.9 L/f Factory set flush, field adjustable



Commercial
H₂Optics[®] Exposed Flush Valve

81T231HWA-19 3 593.60 Chrome

- Electronic exposed flush valve
- Hands-free activation
- H₂Optics[®] Technology
- For 3/4" top inlet urinal fixture
- Body mounted sensor
- Hardwire, order transformer separately
- Order transformer separately
- 0.5 gpf, 1.9 L/f Factory set flush, NOT field adjustable



Model	Case	Price	Finish	Features
-------	------	-------	--------	----------



Commercial
H₂Optics[®] Exposed Flush Valve

81T201-48-WMSHWA	1	739.00	Chrome
81T201-6-WMSHWA	1	739.00	Chrome
81T201-WMSHWA	1	739.00	Chrome
81T201-WMSHWA-BB	1	783.35	Chrome

For complete 81T series product offering, see pages C127–C131.

- Electronic exposed flush valve
- Hands-free activation
- H₂Optics[®] Technology
- For 1 1/2" top inlet water closet fixture
- Wall mount sensor
- Hardwire, order transformer separately
- 81T201-48-WMSHWA - 1.27 gpf, 4.8 L/f Factory set flush, NOT field adjustable
- 81T201-6-WMSHWA - 1.6 gpf, 6.0 L/f Factory set flush, NOT field adjustable
- 81T201-WMSHWA - 1.6 gpf, 6.0 L/f Factory set flush, field adjustable
- 81T201-WMSHWA-BB - 1.6 gpf, 6.0 L/f Factory set flush, field adjustable, battery back-up



Commercial
H₂Optics[®] Exposed Flush Valve

81T231-WMSHWA	1	739.00	Chrome
81T231-WMSHWA-BB	1	783.35	Chrome

- Electronic exposed flush valve
- Hands-free activation
- H₂Optics[®] Technology
- For 3/4" top inlet urinal fixture
- Wall mount sensor
- Hardwire, order transformer separately
- 81T231-WMSHWA - 0.5 gpf, 1.9 L/f Factory set flush, field adjustable
- 81T231-WMSHWA-BB - 0.5 gpf, 1.9 L/f Factory set flush, field adjustable, battery back-up



Commercial
H₂Optics[®] Exposed Flush Valve

81T231-05-WMSHWA	1	739.00	Chrome
81T231-19-WMSHWA	1	739.00	Chrome

- Electronic exposed flush valve
- Hands-free activation
- H₂Optics[®] Technology
- For 3/4" top inlet urinal fixture
- Wall mount sensor
- Hardwire, order transformer separately
- 81T231-05-WMSHWA - 0.125 gpf, 0.5 L/f Factory set flush, NOT field adjustable
- 81T231-19-WMSHWA - 0.5 gpf, 1.9 L/f Factory set flush, NOT field adjustable



Model Case Price Finish Features



Commercial
Electronic Concealed Flush Valve Rough

1600T6103ARI	1	482.80	NA
1600T6103ARI-48	1	482.80	NA
1600T6103ARI-6	1	482.80	NA

For complete 1600T series product offering, see pages C132–C133.

- Electronic concealed flush valve rough
- Requires separate order of 1600T6103ATR trim for complete product
- Supplied as complete flush valve and wall access frame
- H₂Optics[®] Technology
- For 1 1/2" back inlet wall hung water closet fixture
- 1600T6103ARI - 1.6 gpf, 6.0 L/f Factory set flush, field adjustable
- 1600T6103ARI-48 - 1.27 gpf, 4.8 L/f Factory set flush, NOT field adjustable
- 1600T6103ARI-6 - 1.6 gpf, 6.0 L/f Factory set flush, NOT field adjustable



Commercial
H₂Optics[®] Concealed Flush Valve Trim

1600T6103ATR	1	482.80	Stainless
--------------	---	--------	-----------

- Electronic concealed flush valve trim
- Requires separate order of 1600T6103ARI rough for complete product
- Supplied as sensor, hardwire converter, solenoid & 14" stainless steel cover
- Hands-free activation
- H₂Optics[®] Technology
- For 1 1/2" back inlet wall hung water closet fixture
- Hardwire, order transformer separately

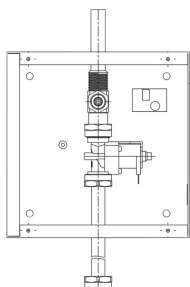

Commercial
H₂Optics[®] Concealed Valve Rough for Washdown Urinals

1600T9001RI	1	381.45	NA
-------------	---	--------	----

- Electronic concealed flush valve rough-in for washdown urinals
- Requires separate order of 1600T9001TR trim for complete product
- Supplied as wall box, stop & outlet hose
- Hands-free activation
- H₂Optics[®] Technology
- For 3/4" back inlet
- Field adjustable flow rate
- 0.5 gpf, 1.9 L/f Factory set flush, field adjustable



Commercial
H₂Optics[®] Concealed Valve Trim for Washdown Urinals

1600T9001TR	3	381.45	Stainless
-------------	---	--------	-----------

- Electronic concealed flush trim rough-in for washdown urinals
- Requires separate order of 1600T9001RI rough for complete product
- Supplied as sensor, hardwire converter, solenoid & 10" stainless steel cover
- Hands-free activation
- H₂Optics[®] Technology
- For 3/4" back inlet
- Hardwire, order transformer separately



Model Case Price Finish Features



Commercial
Electronic Washdown Urinal Valve

DEMD-86505 6 453.95 Chrome

- Electronic washdown urinal valve less vacuum breaker
- Hands-free activation
- Battery operated
- Batteries included
- 0.5 gpf, 1.9 L/f Factory set flush, field adjustable
- Installation Warning: Model shown must be installed on a fixture providing sufficient air gap protection against backflow



Commercial
Electronic Washdown Urinal Valve

DEMD-86515 6 479.80 Chrome

- Electronic washdown urinal valve with vacuum breaker
- Hands-free activation
- Battery operated
- Batteries included
- 0.5 gpf, 1.9 L/f Factory set flush, field adjustable



Commercial
Electronic Washdown Urinal Valve

DEMD-86405 3 428.10 Chrome

- Retrofit electronic washdown urinal valve less vacuum breaker
- Hands-free activation
- Replaces 86T505 manual valve
- Retrofits to stop for 86T505 less vacuum breaker
- Battery operated
- Batteries included
- 0.5 gpf, 1.9 L/f Factory set flush, field adjustable
- Installation Warning: Model shown must be installed on a fixture providing sufficient air gap protection against backflow



Model	Case	Price	Finish	Features
-------	------	-------	--------	----------



Commercial
Electronic Washdown Urinal Valve

DEMD-86415	6	453.95	Chrome
------------	---	--------	--------

- Retrofit electronic washdown urinal valve with vacuum breaker
- Hands-free activation
- Replaces 86T505 manual valve and 86T610 VB outlet
- Retrofits to stop for 86T505 with vacuum breaker
- Battery operated
- Batteries included
- 0.5 gpf, 1.9 L/f Factory set flush, field adjustable



Commercial
Washdown Urinal Valve

86T505	1	155.55	Chrome
--------	---	--------	--------

For complete 86T series product offering, see page C124.

- Cast urinal valve
- For washdown urinal only
- 1/2" back inlet stop
- Vandal resistant handle
- Metering, slow-close lever style
- For 3/4" IP spud
- 0.5 gpf, 1.9 L/f Factory set flush, field adjustable
- Installation Warning: Model shown above must be installed on a fixture providing sufficient air gap protection against backflow



Model Case Price Finish Features



Commercial
Bedpan Washer Water Closet Flushometer

81TBP000 1 609.00 Chrome

For additional bedpan cleanser models, see page C120.

- Bedpan washer water closet flushometer
- With bedpan washer diverter assembly
- 34.38" height from inlet c/l to top of fixture
- For floor mounted or wall mounted top spud bowls
- External water conserving flush volume adjustment
- 1.6 gpm @ 60psi, 6.8 L/min @ 414kPa
Factory set flush, field adjustable



Commercial
Bedpan Washer Water Closet Flushometer

81TBP100 1 609.00 Chrome

- Bedpan washer water closet flushometer
- Meets ADA height requirements
- With bedpan washer diverter assembly
- 26.5" height from inlet c/l to top of fixture
- For floor mounted or wall mounted top spud bowls
- External water conserving flush volume adjustment
- 1.6 gpm @ 60psi, 6.8 L/min @ 414kPa
Factory set flush, field adjustable



Commercial
Bedpan Washer Water Closet Flushometer

81TBP150 1 654.00 Chrome

- Bedpan washer water closet flushometer
- Meets ADA height requirements
- With bedpan washer diverter assembly
- 26.5" height from inlet c/l to top of fixture
- For installation where clearance is required around grab bars
- For floor mounted or wall mounted top spud bowls
- External water conserving flush volume adjustment
- 1.6 gpm @ 60psi, 6.8 L/min @ 414kPa
Factory set flush, field adjustable

How To Order A Complete MultiChoice® 13, 14 & 17 Series Tub/Shower Faucet

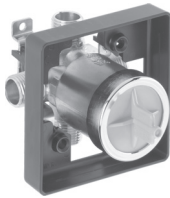
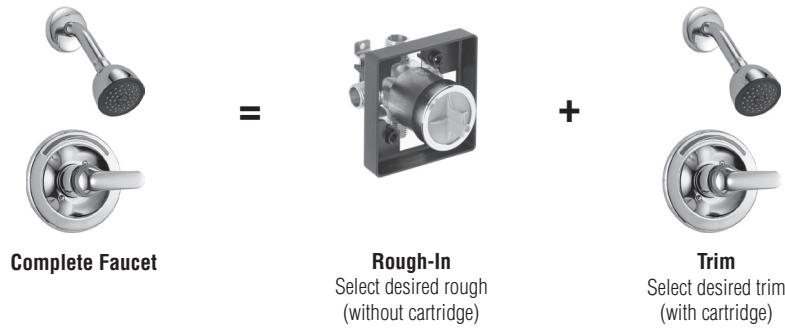

Model	Case	Price	Finish	Features
-------	------	-------	--------	----------

MultiChoice® Universal Tub/Shower Rough Universal Inlets/Outlets

R10000-UN	12•	50.70	NA
R10000-UNBX	3	50.70	NA
R10000-UNBXT	3	54.40	NA
R10000-UNWS	12	71.10	NA
R10000-UNWSBXT	3	74.80	NA

- Valve body only
- Accepts single-function (13/14), dual-function (17), or dual-function thermostatic (17T) cartridge
- Cartridge ships with trim kit
- 1/2" universal inlets accept 1/2" copper, 1/2" iron pipe, PEX or CPVC adapters
- 1/2" universal outlets, inlets/outlets have male threads
- Back-to-back capability
- BX = single box model
- BXT = single box model, thin wall mounting kit included
- WS = with stops, single box model

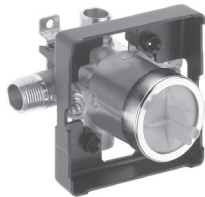

MultiChoice® Universal High-Flow Shower Rough Universal Inlets/Outlets

R10000-UNBXHF	3	50.70	NA
R10000-UNWSHF	12	71.10	NA

- Valve body only
- Shower only
- No tub outlet
- Accepts single-function (13/14), dual-function (17), or dual-function thermostatic (17T) cartridge
- Cartridge ships with trim kit
- 1/2" universal inlets accept 1/2" copper, 1/2" iron pipe, PEX or CPVC adapters
- 1/2" universal outlets, inlets/outlets have male threads
- Back-to-back capability
- BX = single box model
- HF = high flow
- WS = with stops, single box model

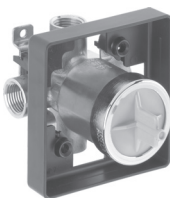

MultiChoice® Universal Tub/Shower Rough IPS Inlets/Outlets

R10000-IP	12•	50.70	NA
R10000-IPWS	12	71.10	NA

- Valve body only
- Accepts single-function (13/14), dual-function (17), or dual-function thermostatic (17T) cartridge
- Cartridge ships with trim kit
- 1/2" female IPS inlets/outlets to accept PEX or CPVC adapters
- Back-to-back capability
- WS = with stops, single box model

• Full case quantity restriction on this model - priced each. Please always order in full case. See pages CI and CII for icon definitions.
Valve rated at minimum 1.25 gpm (4.7 L/min) for 13/14 series pressure balance; 1.5 gpm (5.7 L/min) for 17 series pressure balance;
2.0 gpm (7.6 L/min) for thermostatic at 45 psi (310kPa). ASSE.1016/ASME A112.1016/CSA B125.16

Model	Case	Price	Finish	Features
-------	------	-------	--------	----------



**MultiChoice® Universal Tub/Shower Rough
PEX Crimp**

R10000-PX	12•	50.70	NA
R10000-PXWS	12	71.10	NA

This valve is designed with an insert fitting that complies with ASTM F1807 and CSA B137.5 and is suitable for use with SDR9 PEX tubing using the crimp ring system of joining. It cannot be used as a cold expansion fitting using a PEX reinforcing ring and PEX tubing.

- Valve body only
- Accepts single-function (13/14), dual-function (17), or dual-function thermostatic (17T) cartridge
- Cartridge ships with trim kit
- 1/2" PEX crimp connections and 1/2" universal outlets with male threads
- Back-to-back capability
- WS = with stops, single box model

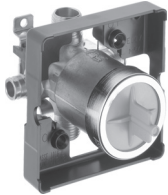

**MultiChoice® Universal Tub/Shower Rough
PEX Cold Expansion**

R10000-MF	12•	50.70	NA
R10000-MFWS	12	71.10	NA

This valve is designed with an insert fitting that complies with ASTM F1960 and is suitable for use with PEX tubing using the cold expansion method of joining. It cannot be used with the crimp ring system of joining.

- Valve body only
- Accepts single-function (13/14), dual-function (17), or dual-function thermostatic (17T) cartridge
- Cartridge ships with trim kit
- 1/2" PEX cold expansion connections and 1/2" universal outlets with male threads
- Back-to-back capability
- MF = PEX cold expansion connections
- WS = with stops, single box model

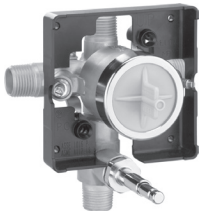

**MultiChoice® Universal Tub/Shower Rough
Push-Button Diverter**

R10300-UNWS	6	163.15	NA
-------------	---	--------	----

- Valve body only for push button diverter
- Accepts single function (13/14)
- Cartridge ships with trim kit
- 1/2" universal inlets to accept
- 1/2" copper, 1/2" iron pipe, PEX or CPVC adapters
- 1/2" universal outlets, inlets/outlets have male threads
- Back-to-back capability
- WS = with stops
- Rough-in for push button diverter









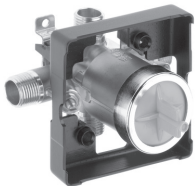















**MultiChoice® Universal Tub/Shower Rough
In-Wall Diverter Valve**

R10700-UNWS	6	118.60	NA
-------------	---	--------	----

- For use with MultiChoice® Universal T13H and T17TH Series with diverter valve for dual showers
- Handle and flange ships with trim



	Model	Case	Price	Finish	Features
   	Vero™  Focus Product <i>Monitor® 14 Series Shower Trim - Less Head</i>				<ul style="list-style-type: none"> • Single-function pressure balance cartridge • Order MultiChoice® Universal rough separately • LHD = Less shower head model • Metal lever handle adjusts temperature • Red/blue pad print escutcheon • RP77991 adds 1 3/4" to max. installation thickness
    	Vero™  Focus Product <i>Monitor® 14 Series Tub & Shower Trim - Less Head</i>				<ul style="list-style-type: none"> • Single-function pressure balance cartridge • Order MultiChoice® Universal rough separately • LHD = Less shower head model • Metal lever handle adjusts temperature • Red/blue pad print escutcheon • RP77991 adds 1 3/4" to max. installation thickness • 7 1/8" pull-up tub spout • Sweat onto 1/2" C.W.T. or thread onto 1/2" IPS
   	Dryden™  Focus Product <i>Monitor® 14 Series Shower Trim - Less Head</i>				<ul style="list-style-type: none"> • Single-function pressure balance cartridge • Order MultiChoice® Universal rough separately • LHD = Less shower head model • Metal lever handle adjusts temperature • Red/blue pad print escutcheon • RP77991 adds 1 3/4" to max. installation thickness
    	Dryden™  Focus Product <i>Monitor® 14 Series Tub & Shower Trim - Less Head</i>				<ul style="list-style-type: none"> • Single-function pressure balance cartridge • Order MultiChoice® Universal rough separately • LHD = Less shower head model • Metal lever handle adjusts temperature • Red/blue pad print escutcheon • RP77991 adds 1 3/4" to max. installation thickness • 7 1/2" pull-up tub spout • Sweat onto 1/2" C.W.T. or thread onto 1/2" IPS

Model Case Price Finish Features



Cassidy™ FP Focus Product
Monitor[®] 14 Series Shower Trim - Less Handle - Less Head

T14297-LHP-LHD	6	143.25	Chrome
T14297-SSLHP-LHD	6	198.90	Brilliance [®] Stainless

- Single-function pressure balance cartridge
- Order MultiChoice[®] Universal rough separately
- LHD = Less shower head model
- Order handle separately (LHP)
- Handle adjusts temperature
- Red/blue pad print escutcheon
- RP77991 adds 1 3/4" to max. installation thickness



Cassidy™ FP Focus Product
Monitor[®] 14 Series Tub & Shower Trim - Less Handle - Less Head

T14497-LHP-LHD	6	179.35	Chrome
T14497-SSLHP-LHD	6	249.05	Brilliance [®] Stainless

- Single-function pressure balance cartridge
- Order MultiChoice[®] Universal rough separately
- LHD = Less shower head model
- Order handle separately (LHP)
- Handle adjusts temperature
- Red/blue pad print escutcheon
- RP77991 adds 1 3/4" to max. installation thickness
- 7 2/3" pull-up tub spout
- Sweat onto 1/2" C.W.T. or thread onto 1/2" IPS



Recommended Cassidy™ Bath Collection Handles.



Handle Part #	Case	List Price
H795	6	53.70
H795CZ	6	81.40
H795PN	6	70.50
H795RB	6	81.40
H795SS	6	70.50



- Metal cross handle
- Sold as single handle
- For 13/14 Series shower and floor mount tub filler applications



Handle Part #	Case	List Price
H797	6	45.70
H797CZ	6	70.75
H797PN	6	64.00
H797RB	6	70.75
H797SS	6	64.00











- Metal lever handle
- Sold as single handle
- For 13/14 Series shower and floor mount tub filler applications



Handle Part #	Case	List Price
H798	6	46.85
H798CZ	6	72.60
H798PN	6	65.65
H798RB	6	72.60
H798SS	6	65.65



- Metal lever handle
- Sold as single handle
- For 13/14 Series shower and floor mount tub filler applications

	Model	Case	Price	Finish	Features
	Addison™ FP Focus Product <i>Monitor® 14 Series Shower Trim - Less Head</i>				<ul style="list-style-type: none"> • Single-function pressure balance cartridge • Order MultiChoice® Universal rough separately • LHD = Less shower head model • Metal lever handle adjusts temperature • Red/blue pad print escutcheon • RP77991 adds 1 3/4" to max. installation thickness
	T14292-LHD	3	140.70	Chrome	
					
	Addison™ FP Focus Product <i>Monitor® 14 Series Tub & Shower Trim - Less Head</i>				<ul style="list-style-type: none"> • Single-function pressure balance cartridge • Order MultiChoice® Universal rough separately • LHD = Less shower head model • Metal lever handle adjusts temperature • Red/blue pad print escutcheon • RP77991 adds 1 3/4" to max. installation thickness • 7 1/2" pull-up tub spout • Sweat onto 1/2" C.W.T. or thread onto 1/2" IPS
	T14492-LHD	3	160.70	Chrome	
					
	Ara® FP Focus Product <i>Monitor® 14 Series Shower Trim - Less Head</i>				<ul style="list-style-type: none"> • Single-function pressure balance cartridge • Order MultiChoice® Universal rough separately • LHD = Less shower head model • Metal lever handle adjusts temperature • Red/blue pad print escutcheon • RP77991 adds 1 3/4" to max. installation thickness
	T14267-LHD	6	160.60	Chrome	
	T14267-SSLHD	6	246.25	Brilliance® Stainless	
					
	Ara® FP Focus Product <i>Monitor® 14 Series Tub & Shower Trim - Less Head</i>				<ul style="list-style-type: none"> • Single-function pressure balance cartridge • Order MultiChoice® Universal rough separately • LHD = Less shower head model • Metal lever handle adjusts temperature • Red/blue pad print escutcheon • RP77991 adds 1 3/4" to max. installation thickness • 7 1/8" pull-up tub spout • Sweat onto 1/2" C.W.T. or thread onto 1/2" IPS
	T14467-LHD	6	192.75	Chrome	
	T14467-SSLHD	6	291.25	Brilliance® Stainless	
					

Model Case Price Finish Features



Compel® FP Focus Product
Monitor® 14 Series Shower Trim - Less Head

T14261-LHD	6	141.55	Chrome
T14261-SSLHD	6	198.15	Brilliance® Stainless

- Single-function pressure balance cartridge
- Order MultiChoice® Universal rough separately
- LHD = Less shower head model
- Metal lever handle adjusts temperature
- Red/blue pad print escutcheon
- RP77991 adds 1 3/4" to max. installation thickness



Compel® FP Focus Product
Monitor® 14 Series Tub & Shower Trim - Less Head

T14461-LHD	6	163.00	Chrome
T14461-SSLHD	6	228.20	Brilliance® Stainless

- Single-function pressure balance cartridge
- Order MultiChoice® Universal rough separately
- LHD = Less shower head model
- Metal lever handle adjusts temperature
- Red/blue pad print escutcheon
- RP77991 adds 1 3/4" to max. installation thickness
- 7" pull-up tub spout
- Sweat onto 1/2" C.W.T. or thread onto 1/2" IPS



Trinsic® FP Focus Product
Monitor® 14 Series Shower Trim - Less Head

T14259-LHD	6	118.20	Chrome
T14259-SSLHD	6	165.50	Brilliance® Stainless

- Single-function pressure balance cartridge
- Order MultiChoice® Universal rough separately
- LHD = Less shower head model
- Metal lever handle adjusts temperature
- Red/blue pad print escutcheon
- RP77991 adds 1 3/4" to max. installation thickness



Trinsic® FP Focus Product
Monitor® 14 Series Tub & Shower Trim - Less Head

T14459-LHD	6	138.60	Chrome
T14459-SSLHD	6	194.10	Brilliance® Stainless

- Single-function pressure balance cartridge
- Order MultiChoice® Universal rough separately
- LHD = Less shower head model
- Metal lever handle adjusts temperature
- Red/blue pad print escutcheon
- RP77991 adds 1 3/4" to max. installation thickness
- 6 1/8" pull-up tub spout
- Sweat onto 1/2" C.W.T. or thread onto 1/2" IPS, converting to slip-on for 1/2" C.W.T Q4 2016



Model	Case	Price	Finish	Features
-------	------	-------	--------	----------



Lahara™
Monitor® 14 Series Shower Trim - Less Head

T14238-LHD	6	110.35	Chrome
T14238-SSLHD	3	161.85	Brilliance® Stainless

- Single-function pressure balance cartridge
- Order MultiChoice® Universal rough separately
- LHD = Less shower head model
- Metal lever handle adjusts temperature
- Red/blue pad print escutcheon
- RP77991 adds 1 3/4" to max. installation thickness



Lahara™
Monitor® 14 Series Tub & Shower Trim - Less Head

T14438-LHD	6	140.40	Chrome
T14438-SSLHD	3	195.45	Brilliance® Stainless

- Single-function pressure balance cartridge
- Order MultiChoice® Universal rough separately
- LHD = Less shower head model
- Metal lever handle adjusts temperature
- Red/blue pad print escutcheon
- RP77991 adds 1 3/4" to max. installation thickness
- 6 3/4" pull-up tub spout
- Sweat onto 1/2" C.W.T. or thread onto 1/2" IPS



Linden™
Monitor® 14 Series Shower Trim - Less Head

T14294-LHD	3	107.20	Chrome
------------	---	--------	--------

- Single-function pressure balance cartridge
- Order MultiChoice® Universal rough separately
- LHD = Less shower head model
- Metal lever handle adjusts temperature
- Red/blue pad print escutcheon
- RP77991 adds 1 3/4" to max. installation thickness



Linden™
Monitor® 14 Series Tub & Shower Trim - Less Head

T14494-LHD	3	141.35	Chrome
------------	---	--------	--------

- Single-function pressure balance cartridge
- Order MultiChoice® Universal rough separately
- LHD = Less shower head model
- Metal lever handle adjusts temperature
- Red/blue pad print escutcheon
- RP77991 adds 1 3/4" to max. installation thickness
- 6 1/2" pull-up tub spout
- Sweat onto 1/2" C.W.T. or thread onto 1/2" IPS

Model	Case	Price	Finish	Features
-------	------	-------	--------	----------



Commercial
Monitor[®] 13 Series Valve Only Trim

T13090	12	76.65	Chrome
--------	----	-------	--------

- Single-function pressure balance cartridge
- Order MultiChoice[®] Universal rough-in separately
- Vandal resistant blade handle adjusts temperature
- Red/blue label on escutcheon



Commercial
Monitor[®] 13 Series Shower Trim

T13290	12	92.45	Chrome
--------	----	-------	--------

- Single-function pressure balance cartridge
- Order MultiChoice[®] Universal rough-in separately
- Vandal resistant blade handle adjusts temperature
- Red/blue label on escutcheon
- Touch-Clean[®] full body shower head
- 2.0 gpm @ 80 psi, 7.6 L/min @ 550 kPa max. water usage



Commercial
Monitor[®] 13 Series Tub & Shower Trim

T13490	12	115.45	Chrome
--------	----	--------	--------

- Single-function pressure balance cartridge
- Order MultiChoice[®] Universal rough-in separately
- Vandal resistant blade handle adjusts temperature
- Red/blue label on escutcheon
- Touch-Clean[®] full body shower head
- 5 1/2" long pull-up diverter spout
- Sweat onto 1/2" C.W.T. or thread onto 1/2" IPS
- 2.0 gpm @ 80 psi, 7.6 L/min @ 550 kPa max. water usage



Commercial
Monitor[®] 13 Series Valve Only Trim

T13091	12	76.65	Chrome
--------	----	-------	--------

- Single-function pressure balance cartridge
- Order MultiChoice[®] Universal rough-in separately
- Metal lever handle adjusts temperature
- Red/blue label on escutcheon



Commercial
Monitor[®] 13 Series Shower Trim

T13291	12	92.45	Chrome
--------	----	-------	--------

- Single-function pressure balance cartridge
- Order MultiChoice[®] Universal rough-in separately
- Metal lever handle adjusts temperature
- Red/blue label on escutcheon
- Touch-Clean[®] full body shower head
- 2.0 gpm @ 80 psi, 7.6 L/min @ 550 kPa max. water usage



Model Case Price Finish Features



Classic
Monitor® 13 Series Shower Trim - Less Head

T13291-LHD	12	79.75	Chrome
T13291-SSLHD	12	111.45	Brilliance® Stainless

- Single-function pressure balance cartridge
- Order MultiChoice® Universal rough separately
- LHD = Less shower head model
- Metal lever handle adjusts temperature
- RP77991 adds 1 3/4" to max. installation thickness
- Red/blue pad print escutcheon



Classic
Monitor® 13 Series Shower Trim - Less Head

T13291-SLHD	12	79.60	Chrome
-------------	----	-------	--------

- Single-function pressure balance cartridge
- Order MultiChoice® Universal rough separately
- LHD = Less shower head model
- Metal lever handle adjusts temperature
- Red/blue pad print escutcheon



Classic
Monitor® 13 Series Tub & Shower Trim - Less Head

T13491-SLHD	12	102.35	Chrome
-------------	----	--------	--------

- Single-function pressure balance cartridge
- Order MultiChoice® Universal rough separately
- LHD = Less shower head
- Metal lever handle adjusts temperature
- 5 1/2" pull-up tub spout
- Sweat onto 1/2" C.W.T. or thread onto 1/2" IPS
- Red/blue pad print escutcheon



Model Case Price Finish Features



Commercial
Monitor® 13 Series Tub & Shower Trim

T13491 12 115.45 Chrome

- Single-function pressure balance cartridge
- Order MultiChoice® Universal rough-in separately
- Metal lever handle adjusts temperature
- Red/blue label on escutcheon
- Touch-Clean® full body shower head
- 5 1/2" pull-up tub spout
- Sweat onto 1/2" C.W.T. or thread onto 1/2" IPS
- 2.0 gpm @ 80 psi, 7.6 L/min @ 550 kPa max. water usage



Commercial
Monitor® 13 Series Tub & Shower Trim - Less Head

T13491-LHD 12 103.30 Chrome
T13491-SSLHD 12 140.05 Brilliance® Stainless

- Single-function pressure balance cartridge
- Order MultiChoice® Universal rough separately
- LHD = Less shower head
- Metal lever handle adjusts temperature
- 5 1/2" pull-up tub spout
- Sweat onto 1/2" C.W.T. or thread onto 1/2" IPS
- RP77991 adds 1 3/4" to max. installation thickness
- Red/blue pad print escutcheon

Model Case Price Finish Features



Commercial
Monitor® 13 Series Valve Only Trim

T13391 12 76.65 Chrome

- Single-function pressure balance cartridge
- Order MultiChoice® Universal push button rough-in separately
- Metal lever handle adjusts temperature
- Red/blue pad print escutcheon
- Push-button diverter



Commercial
Monitor® 13 Series Tub & Shower Trim

T13691 12 115.45 Chrome

- Single-function pressure balance cartridge
- Order MultiChoice® Universal push-button rough-in separately
- Metal lever handle adjusts temperature
- Red/blue pad print escutcheon
- Push-button diverter
- Touch-Clean® full body shower head
- Metal tub filler
- Thread onto 1/2" IPS
- 2.0 gpm @ 80 psi, 7.6 L/min @ 550 kPa max. water usage



Classic
Monitor® 13 Series Tub & Shower Trim

T13691-SOS-15 3 144.25 Chrome

- Single-function pressure balance cartridge
- Order MultiChoice® Universal rough separately
- Metal lever handle adjusts temperature
- Red/blue pad print escutcheon
- Push-button diverter
- Touch-Clean® full body shower head
- Metal tub filler
- Slip onto 1/2" C.W.T
- Removable threaded adapter for 1/2" IPS
- 1.5 gpm @ 80 psi, 5.7 L/min @ 550 kPa max. water usage



Model	Case	Price	Finish	Features
-------	------	-------	--------	----------



Commercial
13 Series Shower Trim

T13H132 6 106.85 Chrome

For complete T13H series product offering, see pages C99–C101.

- Single function pressure balance cartridge
- Order MultiChoice® Universal rough-in separately
- Vandal resistant lever handle adjusts temperature
- Red/blue non-removable marking on escutcheon
- Touch-Clean® full body shower head
- 1.5 gpm @ 80 psi, 5.7 L/min @ 550 kPa max. water usage



Commercial
13 Series Tub & Shower Trim

T13H232 6 127.15 Chrome

- Single function pressure balance cartridge
- Order MultiChoice® Universal rough-in separately
- Vandal resistant lever handle adjusts temperature
- Red/blue non-removable marking on escutcheon
- Pull-up metal diverter spout
- Touch-Clean® full body shower head
- 1.5 gpm @ 80 psi, 5.7 L/min @ 550 kPa max. water usage



Commercial
13 Series Shower Trim

T13H152 1 279.55 Chrome

- Single function pressure balance cartridge
- Order MultiChoice® Universal rough-in separately
- Vandal resistant lever handle adjusts temperature
- Red/blue non-removable marking on escutcheon
- 24" long, 1 1/2" stainless slide bar / grab bar
- 70" vinyl hose
- ADA adjustable mount, hand shower and hose
- ADA compliant grab bar when installed per accessibility guidelines of the act
- Touch-Clean® two-setting hand shower
- 1.5 gpm @ 80 psi, 5.7 L/min @ 550 kPa max. water usage
- Pause, Full Body Spray



Commercial
13 Series Shower Trim

T13H163 6 237.65 Chrome

- Single function pressure balance cartridge
- Order MultiChoice® Universal rough-in separately
- Vandal resistant lever handle adjusts temperature
- Red/blue non-removable marking on escutcheon
- 30° Vandal resistant cast shower head
- 1.5 gpm @ 80 psi, 5.7 L/min @ 550 kPa max. water usage



	Model	Case	Price	Finish	Features
	Commercial 13 Series Shower Trim				<ul style="list-style-type: none"> • Single function pressure balance cartridge • Order MultiChoice® Universal rough-in separately • Vandal resistant blade handle adjusts temperature • Red/blue non-removable marking on escutcheon • 24" long, 1 1/2" stainless slide bar / grab bar • 70" vinyl hose • ADA adjustable mount, hand shower and hose • ADA compliant grab bar when installed per accessibility guidelines of the act • Touch-Clean® two-setting hand shower • 1.5 gpm @ 80 psi, 5.7 L/min @ 550 kPa max. water usage • Pause, Full Body Spray
	T13H153	1	279.55	Chrome	
For complete T13H series product offering, see pages C99–C101.					
	Commercial 13 Series Tub & Shower Trim				<ul style="list-style-type: none"> • Single function pressure balance cartridge • Order MultiChoice® Universal rough-in separately • Vandal resistant blade handle adjusts temperature • Red/blue non-removable marking on escutcheon • 24" long, 1 1/2" stainless slide bar / grab bar • 70" vinyl hose • ADA adjustable mount, hand shower and hose • ADA compliant grab bar when installed per accessibility guidelines of the act • Touch-Clean® two-setting hand shower • Pull-up metal diverter spout • 1.5 gpm @ 80 psi, 5.7 L/min @ 550 kPa max. water usage • Pause, Full Body Spray
	T13H253	1	299.85	Chrome	
	Commercial 13 Series Shower Trim				<ul style="list-style-type: none"> • Single function pressure balance cartridge • Diverter valve • Order R10700-UNWS MultiChoice® Universal rough-in separately • Vandal resistant blade handle adjusts temperature • Red/blue non-removable marking on escutcheon • 24" long, 1 1/2" stainless slide bar / grab bar • 70" vinyl hose • ADA adjustable mount, hand shower and hose • ADA compliant grab bar when installed per accessibility guidelines of the act • Touch-Clean® full body shower head • Touch-Clean® two-setting hand shower • 1.5 gpm @ 80 psi, 5.7 L/min @ 550 kPa max. water usage • Pause, Full Body Spray
	T13H333	1	440.70	Chrome	

Model Case Price Finish Features



Commercial
TempAssure® 17T Series Shower Trim

T17TH125 6 393.35 Chrome

For complete T17TH series product offering, see pages C102–C104.

- Single function thermostatic cartridge
- Order MultiChoice® Universal rough-in separately
- Vandal resistant handle adjusts volume
- Red/blue non-removable marking
- Dial adjusts temperature
- 3-Setting Touch-Clean® shower head
- 2.0 gpm @ 80 psi, 7.6 L/min @ 550 kPa max. water usage
- Full Body Spray, Massage Spray, Soft-Drench Spray

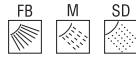

Commercial
TempAssure® 17T Series Shower Trim

T17TH155 1 526.70 Chrome

- Single function thermostatic cartridge
- Order MultiChoice® Universal rough-in separately
- Vandal resistant handle adjusts volume
- Red/blue non-removable marking
- Dial adjusts temperature
- 24" long, 1 1/2" stainless slide bar / grab bar
- 70" vinyl hose
- ADA adjustable mount, hand shower and hose
- ADA compliant grab bar when installed per accessibility guidelines of the act
- Touch-Clean® two-setting hand shower
- 2.5 gpm @ 80 psi, 9.5 L/min @ 550 kPa
- Pause, Full Body Spray



Commercial
TempAssure® 17T Series Tub & Shower Trim

T17TH225 6 413.65 Chrome

- Single function thermostatic cartridge
- Order MultiChoice® Universal rough-in separately
- Vandal resistant handle adjusts volume
- Red/blue non-removable marking
- Dial adjusts temperature
- Pull-up metal diverter spout
- 3-Setting Touch-Clean® shower head
- 2.0 gpm @ 80 psi, 7.6 L/min @ 550 kPa max. water usage
- Full Body Spray, Massage Spray, Soft-Drench Spray

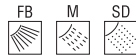

Model Case Price Finish Features



Commercial
Adjustable Slide Bar / Grab Bar Assembly

RPW124HDF 1 173.65 Stainless and White

- Two-setting white hand shower
- Two integral check valves for backflow protection
- Features Touch-Clean® spray holes
- Push button water control
- 24" long, 1 1/2" stainless slide bar / grab bar
- ADA adjustable mount, hand shower and hose
- ADA compliant grab bar when installed per accessibility guidelines of the act
- 60"-82" stretchable metal hose
- 2.5 gpm @ 80 psi, 9.5 L/min @ 550 kPa
- Pause, Full Body Spray



Commercial
Adjustable Slide Bar / Grab Bar Assembly

RPW136HDF 1 191.45 Stainless and White

- Two-setting white hand shower
- Two integral check valves for backflow protection
- Features Touch-Clean® spray holes
- Push button water control
- 36" long, 1 1/2" stainless slide bar / grab bar
- ADA adjustable mount, hand shower and hose
- ADA compliant grab bar when installed per accessibility guidelines of the act
- 60"-82" stretchable metal hose
- 2.5 gpm @ 80 psi, 9.5 L/min @ 550 kPa
- Pause, Full Body Spray



Commercial
Adjustable Slide Bar / Grab Bar Assembly

RPW324HDF 1 225.95 Stainless and White

- Two-setting white hand shower
- Two integral check valves for backflow protection
- Features Touch-Clean® spray holes
- Push button water control
- 24" long, 1 1/2" stainless slide bar / grab bar
- ADA adjustable mount, hand shower and hose
- ADA compliant grab bar when installed per accessibility guidelines of the act
- 60"-82" stretchable metal hose
- 90° chrome wall supply elbow
- 2.5 gpm @ 80 psi, 9.5 L/min @ 550 kPa
- Pause, Full Body Spray



Model Case Price Finish Features



Commercial
Hand Shower with ADA Slide Bar / Grab Bar

RPW324HDF-1.5 4 225.95 Stainless and White

- Two-setting white hand shower
- Two integral check valves for backflow protection
- Features Touch-Clean® spray holes
- Push button water control
- 24" long, 1 1/2" stainless slide bar / grab bar
- ADA adjustable mount, hand shower and hose
- ADA compliant grab bar when installed per accessibility guidelines of the act
- 60"-82" stretchable metal hose
- 90° chrome wall supply elbow
- 1.5 gpm @ 60 psi, 5.7 L/min @ 414 kPa
- Pause, Full Body Spray



Commercial
Adjustable Slide Bar / Grab Bar Assembly - Less Hand Shower

RPW324HDF-LHD 1 213.20 Stainless

- 24" long, 1 1/2" stainless slide bar / grab bar
- ADA adjustable mount and hose
- ADA compliant grab bar when installed per accessibility guidelines of the act
- 60"-82" stretchable metal hose
- 90° chrome wall supply elbow
- LHD = Less hand shower model



Commercial
Adjustable Slide Bar / Grab Bar Assembly

RPW336HDF 1 243.90 Stainless and White

- Two-setting white hand shower
- Two integral check valves for backflow protection
- Features Touch-Clean® spray holes
- Push button water control
- 36" long, 1 1/2" stainless slide bar / grab bar
- ADA adjustable mount, hand shower and hose
- ADA compliant grab bar when installed per accessibility guidelines of the act
- 60"-82" stretchable metal hose
- 90° chrome wall supply elbow
- 2.5 gpm @ 80 psi, 9.5 L/min @ 550 kPa
- Pause, Full Body Spray



Model Case Price Finish Features



Universal Showering
H₂OkinetiC[®] 3-Setting Raincan Shower Head

52687	3	155.35	Chrome
52687-CZ	3	277.50	Champagne Bronze™
52687-PN	3	245.35	Polished Nickel
52687-RB	3	277.50	Venetian Bronze®
52687-SS	3	245.35	Brilliance® Stainless

- Three-setting H₂OkinetiC[®] shower head
- Self-cleaning H₂OkinetiC spray holes
- Touch-Clean[®] spray holes
- 8 1/4" spray face diameter
- 3 7/8" shower head length
- 2.0 gpm @ 80 psi, 7.6 L/min @ 550 kPa maximum water usage
- Pause, Full Body Spray, H₂OkinetiC Spray

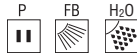

Universal Showering
H₂OkinetiC[®] 3-Setting Raincan Shower Head

52688	3	144.65	Chrome
52688-CZ	3	251.75	Champagne Bronze™
52688-RB	3	251.75	Venetian Bronze®
52688-SS	3	223.95	Brilliance® Stainless

- Three-setting H₂OkinetiC[®] shower head
- Self-cleaning H₂OkinetiC spray holes
- Touch-Clean[®] spray holes
- 7 3/4" spray face diameter
- 3 1/2" shower head length
- 2.0 gpm @ 80 psi, 7.6 L/min @ 550 kPa maximum water usage
- Pause, Full Body Spray, H₂OkinetiC Spray

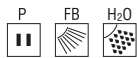

Universal Showering
H₂OkinetiC[®] 3-Setting Raincan Shower Head

52686	3	144.65	Chrome
52686-CZ	3	251.75	Champagne Bronze™
52686-RB	3	251.75	Venetian Bronze®
52686-SS	3	223.95	Brilliance® Stainless

- Three-setting H₂OkinetiC[®] shower head
- Self-cleaning H₂OkinetiC spray holes
- Touch-Clean[®] spray holes
- 7 3/4" spray face diameter
- 3 3/8" shower head length
- 2.0 gpm @ 80 psi, 7.6 L/min @ 550 kPa maximum water usage
- Pause, Full Body Spray, H₂OkinetiC Spray

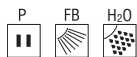

Universal Showering
H₂OkinetiC[®] 3-Setting Raincan Shower Head

52684	3	150.00	Chrome
52684-CZ	3	257.10	Champagne Bronze™
52684-PN	3	230.35	Polished Nickel
52684-RB	3	257.10	Venetian Bronze®
52684-SS	3	230.35	Brilliance® Stainless

- Three-setting H₂OkinetiC[®] shower head
- Self-cleaning H₂OkinetiC spray holes
- Touch-Clean[®] spray holes
- 7 5/8" spray face diameter
- 3 1/2" shower head length
- 2.0 gpm @ 80 psi, 7.6 L/min @ 550 kPa maximum water usage
- Pause, Full Body Spray, H₂OkinetiC Spray

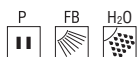

Model
Case
Price
Finish
Features
Universal Showering
H₂Okinetic[®] 5-Setting Shower Head

52638-15-PK	6	95.40	Chrome
52638-CZ15-PK	6	159.65	Champagne Bronze™
52638-PN15-PK	6	148.95	Polished Nickel
52638-RB15-PK	6	159.65	Venetian Bronze®
52638-SS15-PK	6	148.95	Brilliance® Stainless

- Five-setting H₂Okinetic[®] showerhead
- Self-cleaning H₂Okinetic spray holes
- Touch-Clean[®] spray holes
- 4 3/16" spray face diameter
- 3 1/4" shower head length
- 1.5 gpm @ 80 psi, 5.7 L/min @ 550 kPa maximum water usage
- Pause, Full Body Spray, Full Spray w/Massage, H₂Okinetic Spray, Massage Spray

Universal Showering
H₂Okinetic[®] 5-Setting Shower Head

52638-20-PK	6	95.40	Chrome
52638-CZ20-PK	6	159.65	Champagne Bronze™
52638-PN20-PK	6	148.95	Polished Nickel
52638-RB20-PK	6	159.65	Venetian Bronze®
52638-SS20-PK	6	148.95	Brilliance® Stainless

- Five-setting H₂Okinetic[®] shower head
- Self-cleaning H₂Okinetic spray holes
- Touch-Clean[®] spray holes
- 4 3/16" spray face diameter
- 3 1/4" shower head length
- 2.0 gpm @ 80 psi, 7.6 L/min @ 550 kPa maximum water usage
- Pause, Full Body Spray, Full Spray w/Massage, H₂Okinetic Spray, Massage Spray

Universal Showering
H₂Okinetic[®] 5-Setting Shower Head

52637-15-PK	6	95.40	Chrome
52637-CZ15-PK	6	159.65	Champagne Bronze™
52637-PN15-PK	6	148.95	Polished Nickel
52637-RB15-PK	6	159.65	Venetian Bronze®
52637-SS15-PK	6	148.95	Brilliance® Stainless

- Five-setting H₂Okinetic[®] shower head
- Self-cleaning H₂Okinetic spray holes
- Touch-Clean[®] spray holes
- 4 1/8" spray face diameter
- 5 1/4" shower head length
- 1.5 gpm @ 80 psi, 5.7 L/min @ 550 kPa maximum water usage
- Pause, Full Body Spray, Full Spray w/Massage, H₂Okinetic Spray, Massage Spray

Universal Showering
H₂Okinetic[®] 5-Setting Shower Head

52637-20-PK	6	95.40	Chrome
52637-CZ20-PK	6	159.65	Champagne Bronze™
52637-PN20-PK	6	148.95	Polished Nickel
52637-RB20-PK	6	159.65	Venetian Bronze®
52637-SS20-PK	6	148.95	Brilliance® Stainless

- Five-setting H₂Okinetic[®] shower head
- Self-cleaning H₂Okinetic spray holes
- Touch-Clean[®] spray holes
- 4 1/8" spray face diameter
- 5 1/4" shower head length
- 2.0 gpm @ 80 psi, 7.6 L/min @ 550 kPa maximum water usage
- Pause, Full Body Spray, Full Spray w/Massage, H₂Okinetic Spray, Massage Spray



Model Case Price Finish Features



Universal Showering
H₂Okinetic® Shower Head

52660-PK	6	75.80	Chrome
52660-RB-PK	6	115.35	Venetian Bronze®
52660-SS-PK	6	104.85	Brilliance® Stainless

- Adjustable setting H₂Okinetic® shower head
- Self-cleaning H₂Okinetic spray holes
- 3 7/8" spray face diameter
- 4 1/2" shower head length
- Adjusts between 2.0 gpm @ 80 psi, 7.6 L/min @ 550 kPa and 1.5 gpm @ 80 psi, 5.7 L/min @ 550 kPa maximum water usage
- 2.0 gpm @ 80 psi, 7.6 L/min @ 550 kPa maximum water usage
- Adjustable H₂Okinetic Spray



Universal Showering
H₂Okinetic® Single-Setting Shower Head

52658-PK	6	59.45	Chrome
52658-SS-PK	6	86.25	Brilliance® Stainless

- Single-setting H₂Okinetic® shower head
- Self-cleaning H₂Okinetic spray holes
- 3 7/8" spray face diameter
- 4 1/2" shower head length
- 1.5 gpm @ 80 psi, 5.7 L/min @ 550 kPa maximum water usage
- H₂Okinetic Spray



Universal Showering
H₂Okinetic® Single-Setting Shower Head

RP54752	6	57.25	Chrome
RP54752CZ	6	95.55	Champagne Bronze™
RP54752RB	6	95.55	Venetian Bronze®
RP54752SS	6	82.95	Brilliance® Stainless

- H₂Okinetic® single-setting shower head
- Self-cleaning H₂Okinetic spray holes
- 3 7/8" spray face diameter
- 4 1/2" shower head length
- 1.5 gpm @ 80 psi, 5.7 L/min @ 550 kPa maximum water usage
- H₂Okinetic Spray



Universal Showering
H₂Okinetic® Single-Setting Shower Head

RP51032	6	83.45	Chrome
RP51032CZ	6	116.90	Champagne Bronze™
RP51032RB	6	116.90	Venetian Bronze®
RP51032SS	6	112.60	Brilliance® Stainless

- Single-setting H₂Okinetic® shower head
- Self-cleaning H₂Okinetic spray holes
- 4" square spray face
- 2 1/2" shower head length
- 1.5 gpm @ 80 psi, 5.7 L/min @ 550 kPa maximum water usage
- H₂Okinetic Spray



Universal Showering
H₂Okinetic® Single-Setting Shower Head

RP46384	6	83.45	Chrome
RP46384CZ	6	166.75	Champagne Bronze™
RP46384RB	6	166.75	Venetian Bronze®
RP46384SS	6	166.75	Brilliance® Stainless

- Single-setting H₂Okinetic® shower head
- Self-cleaning H₂Okinetic spray holes
- 3 1/4" spray face diameter
- 4 3/4" shower head length
- 1.5 gpm @ 80 psi, 5.7 L/min @ 550 kPa maximum water usage
- H₂Okinetic Spray



Model	Case	Price	Finish	Features
-------	------	-------	--------	----------



Universal Showering
H₂Okinetik[®] Single-Setting Shower Head

52655	6	49.00	Chrome
-------	---	-------	--------

- Single-setting H₂Okinetik[®] shower head
- Self-cleaning H₂Okinetik[®] spray holes
- 4" spray face diameter
- 4 1/2" shower head length
- 1.5 gpm @ 80 psi, 5.7 L/min @ 550 kPa maximum water usage
- H₂Okinetik Spray



Universal Showering
Touch-Clean[®] 5-Setting Water-Efficient Vandal Resistant Shower Head

52634-20VP-PK	6	44.10	Chrome
---------------	---	-------	--------

- Five-setting shower head
- Features Touch-Clean[®] spray holes
- Vandal Resistant
- 3 3/8" spray face diameter
- 3 3/4" shower head length
- 2.0 gpm @ 80 psi, 7.6 L/min @ 550 kPa maximum water usage
- Pause, Full Body Spray, Full Spray w/Massage, Fast Massage, High-Efficiency Spray



Universal Showering
Premium Touch-Clean[®] 5-Setting Shower Head

52634-15-BG	10	38.50	Chrome
-------------	----	-------	--------

- Five-setting shower head
- Features Touch-Clean[®] spray holes
- 3 3/8" spray face diameter
- 3 3/4" shower head length
- Bulk packed
- 1.5 gpm @ 80 psi, 5.7 L/min @ 550 kPa maximum water usage
- Pause, Full Body Spray, Full Spray w/Massage, Fast Massage, High-Efficiency Spray



Universal Showering
Fundamentals[™] Single-Setting Shower Head

52653-PK	6	24.60	Chrome
52653-SS-PK	6	33.10	Brilliance [®] Stainless

- Single-setting shower head
- 2 1/4" spray face diameter
- 3 3/4" shower head length
- 1.5 gpm @ 80 psi, 5.7 L/min @ 550 kPa maximum water usage
- High-Efficiency Spray

























Universal Showering
Fundamentals[™] Single-Setting Shower Head

52653-BG	10	24.60	Chrome
----------	----	-------	--------

- Single-setting shower head
- 2 1/4" spray face diameter
- 3 3/4" showerhead length
- 1.5 gpm @ 80 psi, 5.7 L/min @ 550 kPa maximum water usage
- High-Efficiency Spray



	Model	Case	Price	Finish	Features
   	Universal Showering <i>Fundamentals™ Adjustable 6-Jet Shower Head</i>				
	52667-15-BG	10	52.50	Chrome	<ul style="list-style-type: none"> Adjustable spray metal shower head 2 1/2" spray face diameter 4 1/4" shower head length Six spray jets 1.5 gpm @ 80 psi, 5.7 L/min @ 550 kPa maximum water usage Adjustable Full Spray
   	Universal Showering <i>Fundamentals™ Touch-Clean® Single-Setting Shower Head</i>				
	52672-15-BG 52672-WH15-BG	10 10	30.35 26.90	Chrome White	<ul style="list-style-type: none"> Single-setting shower head Features Touch-Clean® spray holes 2 7/8" spray face diameter 3 1/2" shower head length Bulk packed 1.5 gpm @ 80 psi, 5.7 L/min @ 550 kPa maximum water usage Full Body Spray
     	Universal Showering <i>Fundamentals™ 3-Setting Shower Head</i>				
	52692-15-BG 52692-WH15-BG	10 10	12.90 11.70	Chrome White	<ul style="list-style-type: none"> Three-setting shower head 3 5/8" spray face diameter Bulk packed 1.5 gpm @ 80 psi, 5.7 L/min @ 550 kPa maximum water usage Full Body Spray, Full Spray w/Massage, Fast Massage
NEW!    	Universal Showering <i>H₂Okinetic® Raincan Single-Setting Shower Head</i>				
	RP70171-15 RP70171-RB15 RP70171-SS15	18 18 18	114.75 172.15 160.65	Chrome Venetian Bronze® Brilliance® Stainless	<ul style="list-style-type: none"> Single-setting H₂Okinetic® shower head Self-cleaning H₂Okinetic spray holes 6" square spray face 5 1/8" shower head length 1.5 gpm @ 80 psi, 5.7 L/min @ 550 kPa maximum water usage H₂Okinetic Spray
NEW    	Universal Showering <i>H₂Okinetic® Raincan Single-Setting Shower Head</i>				
	RP70175-15 RP70175-RB15 RP70175-SS15	18 18 18	108.05 161.90 151.50	Chrome Venetian Bronze® Brilliance® Stainless	<ul style="list-style-type: none"> Single-setting H₂Okinetic® shower head Self-cleaning H₂Okinetic spray holes 5 1/2" spray face diameter 2 5/8" shower head length 1.5 gpm @ 80 psi, 5.7 L/min @ 550 kPa maximum water usage H₂Okinetic Spray



Model Case Price Finish

Universal Showering
ActiviTouch® 9-Setting Adjustable Wall Mount Hand Shower

55424	6	145.55	Chrome
55424-RB	6	316.05	Venetian Bronze®
55424-SS	6	275.00	Brilliance® Stainless
55424-WC	6	139.75	White/Chrome

- Nine-setting hand shower
- Features Touch-Clean® spray holes
- 60" - 82" stretchable metal hose
- Soft-Touch® grip
- Push button spray selection
- Adjustable wall mount
- 2.5 gpm @ 80 psi, 9.5 L/min @ 550 kPa
- Pause, Full Body Spray, Full Spray w/Massage, Fast Massage, Soft Drench Spray, Shampoo Rinsing Spray, Soft Drench w/Massage, Shampoo Rinsing Spray w/Massage, Soft Full Spray

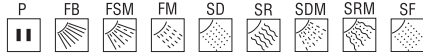

Universal Showering
ActiviTouch® 9-Setting Hand Shower

59424-PK	6	74.55	Chrome
59424-RB-PK	6	128.55	Venetian Bronze®
59424-SS-PK	6	111.85	Brilliance® Stainless
59424-WC-PK	6	71.10	White/Chrome

- Nine-setting hand shower
- Features Touch-Clean® spray holes
- Hand shower only—hose NOT included
- Soft-Touch® grip
- Push button spray selection
- 2.5 gpm @ 80 psi, 9.5 L/min @ 550 kPa
- Pause, Full Body Spray, Full Spray w/Massage, Fast Massage, Soft Drench Spray, Shampoo Rinsing Spray, Soft Drench w/Massage, Shampoo Rinsing Spray w/Massage, Soft Full Spray



Universal Showering
ActiviTouch® 9-Setting Shower Mount Hand Shower

54424-20-PK	6	108.35	Chrome
54424-RB20-PK	6	232.60	Venetian Bronze®
54424-SS20-PK	6	202.30	Brilliance® Stainless
54424-WC20-PK	6	104.85	White/Chrome

- Nine-setting hand shower
- Features Touch-Clean® spray holes
- 60" - 82" stretchable metal hose
- Soft-Touch® grip
- Push button spray selection
- Shower arm mount
- Shower arm and flange NOT included
- 2.0 gpm @ 80 psi, 7.6 L/min @ 550 kPa maximum water usage
- Pause, Full Body Spray, Full Spray w/Massage, Fast Massage, Soft Drench Spray, Shampoo Rinsing Spray, Soft Drench w/Massage, Shampoo Rinsing Spray w/Massage, Soft Full Spray



Universal Showering
ActiviTouch® 9-Setting Hand Shower

59424-20-PK	6	74.55	Chrome
59424-RB20-PK	6	128.55	Venetian Bronze®
59424-SS20-PK	6	111.85	Brilliance® Stainless
59424-WC20-PK	6	71.10	White/Chrome

- Nine-setting hand shower
- Features Touch-Clean® spray holes
- Hand shower only—hose NOT included
- Soft-Touch® grip
- Push button spray selection
- 2.0 gpm @ 80 psi, 7.6 L/min @ 550 kPa maximum water usage
- Pause, Full Body Spray, Full Spray w/Massage, Fast Massage, Soft Drench Spray, Shampoo Rinsing Spray, Soft Drench w/Massage, Shampoo Rinsing Spray w/Massage, Soft Full Spray



Model Case Price Finish

Features



Universal Showering
Palm® 4-Setting Slide Bar / Grab Bar Hand Shower

53001-DS 1 244.45 Chrome

- Four-setting hand shower
- Push-button spray selection
- Features Touch-Clean® spray holes
- 60" - 82" stretchable metal hose
- ADA compliant adjustable mount, hand shower and hose
- ADA compliant grab bar when installed per accessibility guidelines of the act
- 24" long, 1 1/4" diameter stainless slide bar/ grab bar
- 2.5 gpm @ 80 psi, 9.5 L/min @ 550 kPa
- Pause, Full Body Spray, Full Spray w/Massage, Fast Massage



Universal Showering
Palm® 4-Setting Slide Bar / Grab Bar Hand Shower

52008-DS 1 211.90 Chrome

- Four-setting hand shower
- Push-button spray selection
- Features Touch-Clean® spray holes
- 60" - 82" stretchable metal hose
- ADA compliant adjustable mount, hand shower and hose
- ADA compliant grab bar when installed per accessibility guidelines of the act
- 24" long, 1 1/2" diameter stainless slide bar/ grab bar
- 2.5 gpm @ 80 psi, 9.5 L/min @ 550 kPa
- Pause, Full Body Spray, Full Spray w/Massage, Fast Massage



Universal Showering
Palm® 4-Setting Shower Mount Hand Shower

54456-PK 6 103.75 Chrome
54456-SS-PK 6 181.60 Brilliance® Stainless

- Four-setting hand shower
- Features Touch-Clean® spray holes
- 60" - 82" stretchable metal hose
- Push-button spray selection
- Shower arm mount
- Shower arm and flange NOT included
- 2.5 gpm @ 80 psi, 9.5 L/min @ 550 kPa
- Pause, Full Body Spray, Full Spray w/Massage, Fast Massage



Universal Showering
Palm® 4-Setting Hand Shower

59456-PK 6 50.15 Chrome
59456-SS-PK 6 72.25 Brilliance® Stainless

- Four-setting hand shower
- Features Touch-Clean® spray holes
- Hand shower only—hose NOT included
- Push-button spray selection
- 2.5 gpm @ 80 psi, 9.5 L/min @ 550 kPa
- Pause, Full Body Spray, Full Spray w/Massage, Fast Massage



Model	Case	Price	Finish	Features
-------	------	-------	--------	----------



Universal Showering
Palm® 4-Setting Shower Mount Hand Shower

54488-PK	6	149.00	Chrome
54488-RB-PK	6	238.00	Venetian Bronze®
54488-SS-PK	6	186.25	Brilliance® Stainless

- Four-setting hand shower
- Features Touch-Clean® spray holes
- 60" - 82" stretchable metal hose
- Push-button spray selection
- Shower arm mount
- Shower arm and flange NOT included
- 2.0 gpm @ 80 psi, 7.6 L/min @ 550 kPa maximum water usage
- Pause, Full Body Spray, Full Spray w/Massage, Fast Massage



Universal Showering
Palm® 4-Setting Hand Shower

59488-PK	6	78.00	Chrome
59488-RB-PK	6	113.10	Venetian Bronze®
59488-SS-PK	6	97.50	Brilliance® Stainless

- Four-setting hand shower
- Features Touch-Clean® spray holes
- Hand shower only—hose NOT included
- Push-button spray selection
- 2.0 gpm @ 80 psi, 7.6 L/min @ 550 kPa maximum water usage
- Pause, Full Body Spray, Full Spray w/Massage, Fast Massage



Model	Case	Price	Finish	Features
-------	------	-------	--------	----------



Universal Showering
Premium 5-Setting Hand Shower

59434-15-BG	10	47.75	Chrome
59434-SS15-BG	10	68.85	Brilliance® Stainless

- Five-setting hand shower
- Features Touch-Clean® spray holes
- Hand shower only—hose NOT included
- Bulk packed
- 1.5 gpm @ 80 psi, 5.7 L/min @ 550 kPa maximum water usage
- Pause, Full Body Spray, Full Spray w/Massage, Fast Massage, High-Efficiency Spray



Universal Showering
Fundamentals™ 2-Setting Hand Shower

59462-B15-BG	10	38.50	Chrome
59462-WHB15-BG	10	28.05	White

- Two-setting hand shower
- Features Touch-Clean® spray holes
- Hand shower only—hose NOT included
- Push button trickle
- Bulk packed
- 1.5 gpm @ 80 psi, 5.7 L/min @ 550 kPa maximum water usage
- Pause, Full Body Spray

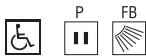

Universal Showering
Fundamentals™ Single-Setting Hand Shower

59462-WH15-BG	10	24.60	White
---------------	----	-------	-------

- Single-setting hand shower
- Features Touch-Clean® spray holes
- Hand shower only—hose NOT included
- Bulk packed
- 1.5 gpm @ 80 psi, 5.7 L/min @ 550 kPa maximum water usage
- Full Body Spray



Universal Showering
Fundamentals™ 3-Setting Shower Mount Hand Shower

54471-15-BG	10	40.85	Chrome
54471-WH15-BG	10	37.30	White

- Three-setting hand shower
- 60" stainless steel hose
- Shower arm mount
- Shower arm and flange NOT included
- Bulk packed
- 1.5 gpm @ 80 psi, 5.7 L/min @ 550 kPa maximum water usage
- Full Body Spray, Full Spray w/Massage, Fast Massage





Model	Case	Price	Finish	Features
Universal Showering <i>Adjustable Pin Mount Wall Bar</i>				<ul style="list-style-type: none"> • 30" long adjustable wall bar w/pin mount • Concealed installation screws
55030	4	137.45	Chrome	



Universal Showering <i>Adjustable Glide Rail Wall Bar</i>				<ul style="list-style-type: none"> • 24" long adjustable glide rail w/pin mount • Adhesive or screw installation
55511-PK	6	102.50	Chrome	



Universal Showering <i>Adjustable Glide Rail Wall Bar</i>				<ul style="list-style-type: none"> • 30" long adjustable glide rail w/pin mount • Adhesive or screw installation
55531	6	128.10	Chrome	



Universal Showering <i>Contemporary Palm® Slide Bar / Grab Bar Hand Shower</i>				<ul style="list-style-type: none"> • Four-setting hand shower • Features Touch-Clean® spray holes • 60-82" stretchable metal hose • Push button spray selection • 24" long, 1 1/4" diameter slide bar / grab bar • ADA compliant adjustable mount, hand shower and hose • ADA compliant grab bar when installed per accessibility guidelines of the act • 2.0 gpm @ 80 psi, 7.6 L/min @ 550 kPa • Pause, Full Body Spray, Full Spray w/Massage, Fast Massage
51400	1	255.00	Chrome	
51400-RB	1	369.75	Venetian Bronze®	
51400-SS	1	318.75	Brilliance® Stainless	



Model Case Price Finish Features



Universal Showering
Traditional ActivTouch® Slide Bar / Grab Bar Hand Shower

51900	1	250.00	Chrome
51900-RB	1	362.50	Venetian Bronze®
51900-SS	1	312.50	Brilliance® Stainless

- Nine-setting hand shower
- Push button spray selection
- Features Touch-Clean® spray holes
- 60-82" stretchable metal hose
- ADA compliant adjustable mount, hand shower and hose
- ADA compliant grab bar when installed per accessibility guidelines of the act
- 24" long, 1 1/4" diameter slide bar / grab bar
- 2.0 gpm @ 80 psi, 7.6 L/min @ 550 kPa
- Pause, Full Body Spray, Full Spray w/Massage, Fast Massage, Soft Drench Spray, Shampoo Rinsing Spray, Soft Drench w/Massage, Shampoo Rinsing Spray w/Massage, Soft Full Spray



Universal Showering
Adjustable Slide Bar / Grab Bar Assembly

56302	1	203.75	Chrome
56302-PB	1	323.75	Brilliance® Polished Brass
56302-RB	1	363.50	Venetian Bronze®
56302-SS	1	318.05	Brilliance® Stainless

- 60" - 82" stretchable metal hose
- 24" long, 1 1/4" diameter slide bar / grab bar
- ADA compliant adjustable mount and hose
- ADA compliant grab bar when installed per accessibility guidelines of the act



Universal Showering
Adjustable Slide Bar / Grab Bar 2-Setting Hand Shower

52001-DS	1	201.40	Brilliance® Stainless
----------	---	--------	-----------------------

- Two-setting hand shower
- 60" - 82" stretchable metal hose
- 24" long, 1 1/2" diameter stainless slide bar / grab bar
- White push button hand shower
- ADA compliant adjustable mount, hand shower and hose
- ADA compliant grab bar when installed per accessibility guidelines of the act
- 2.5 gpm @ 80 psi, 9.5 L/min @ 550 kPa
- Pause, Full Body Spray



Model	Case	Price	Finish	Features
-------	------	-------	--------	----------



Universal Showering
Adjustable Slide Bar / Grab Bar 2-Setting Hand Shower

52001-UF	1	182.80	Brilliance® Stainless
----------	---	--------	-----------------------

- Two-setting hand shower
- 70" UltraFlex® hose
- 24" long, 1 1/2" diameter stainless slide bar / grab bar
- White push button hand shower
- ADA compliant adjustable mount, hand shower and hose
- ADA compliant grab bar when installed per accessibility guidelines of the act
- 2.5 gpm @ 80 psi, 9.5 L/min @ 550 kPa
- Pause, Full Body Spray

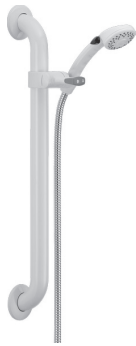

Universal Showering
Adjustable Slide Bar / Grab Bar 2-Setting Hand Shower

52002-DS	1	206.00	White
----------	---	--------	-------

- Two-setting hand shower
- 60" - 82" stretchable metal hose
- 24" long, 1 1/2" diameter white slide bar / grab bar
- White push button hand shower
- ADA compliant adjustable mount, hand shower and hose
- ADA compliant grab bar when installed per accessibility guidelines of the act
- 2.5 gpm @ 80 psi, 9.5 L/min @ 550 kPa
- Pause, Full Body Spray

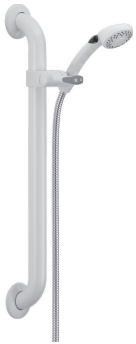

Universal Showering
Adjustable Slide Bar / Grab Bar 2-Setting Hand Shower

52002-UF	1	194.45	White
----------	---	--------	-------

- Two-setting hand shower
- 70" UltraFlex® hose
- 24" long, 1 1/2" diameter white slide bar / grab bar
- White push button hand shower
- ADA compliant adjustable mount, hand shower and hose
- ADA compliant grab bar when installed per accessibility guidelines of the act
- 2.5 gpm @ 80 psi, 9.5 L/min @ 550 kPa
- Pause, Full Body Spray





Model	Case	Price	Finish	Features
Universal Showering <i>Adjustable Slide Bar / Grab Bar 2-Setting Hand Shower</i>				

52003-DS	1	223.50	Brilliance® Stainless	
----------	---	--------	-----------------------	--

- Two-setting hand shower
- 60" - 82" stretchable metal hose
- 36" long, 1 1/2" diameter stainless slide bar / grab bar
- White push button hand shower
- ADA compliant adjustable mount, hand shower and hose
- ADA compliant grab bar when installed per accessibility guidelines of the act
- 2.5 gpm @ 80 psi, 9.5 L/min @ 550 kPa
- Pause, Full Body Spray



Universal Showering <i>Adjustable Slide Bar / Grab Bar 2-Setting Hand Shower</i>				
--	--	--	--	--

52003-UF	1	206.00	Brilliance® Stainless	
----------	---	--------	-----------------------	--

- Two-setting hand shower
- 70" UltraFlex® hose
- 36" long, 1 1/2" diameter stainless slide bar / grab bar
- White push button hand shower
- ADA compliant adjustable mount, hand shower and hose
- ADA compliant grab bar when installed per accessibility guidelines of the act
- 2.5 gpm @ 80 psi, 9.5 L/min @ 550 kPa
- Pause, Full Body Spray



Universal Showering <i>ADA Grab Bar Hand Shower Mount</i>				
---	--	--	--	--

U6300	6	24.60	Black	
U6300-WH	6	24.60	White	

- Fits 1 1/2" or 1 1/4" round grab bars
- Installs vertically or horizontally
- Rotatable hand shower mount



















Universal Showering <i>ADA Grab Bar Hand Shower Mount</i>				
---	--	--	--	--









U6400	6	32.90	Chrome	
U6400-RB	6	43.35	Venetian Bronze®	
U6400-SS	6	41.15	Brilliance® Stainless	

















- Fits 1 1/2" or 1 1/4" round grab bars
- Installs vertically or horizontally
- Rotatable hand shower mount
- Finished surfaces to coordinate with grab bars





	Model	Case	Price	Finish	Features
 	Commercial <i>ADA Grab Bar</i>				<ul style="list-style-type: none"> • 18" long • 1 1/2" diameter • 1 1/2" wall clearance • Supports up to 500 lbs when properly installed • Meets ADA standards • Concealed mounting • Type 304 stainless steel • Grab bar - 18 gauge • 3" diameter flanges - 14 gauge • Snap lock covers - 20 gauge • Mounting hardware included
	40118-PS	3•	34.75	Peened Stainless Steel	
	40118-SS	3•	26.75	Brilliance® Stainless	
 	Commercial <i>ADA Grab Bar</i>				<ul style="list-style-type: none"> • 24" long • 1 1/2" diameter • 1 1/2" wall clearance • Supports up to 500 lbs when properly installed • Meets ADA standards • Concealed mounting • Type 304 stainless steel • Grab bar - 18 gauge • 3" diameter flanges - 14 gauge • Snap lock covers - 20 gauge • Mounting hardware included
	40124-PS	3•	40.15	Peened Stainless Steel	
	40124-SS	3•	29.80	Brilliance® Stainless	
	40124-ST	3•	40.15	Bright Stainless Steel	
 	Commercial <i>ADA Grab Bar</i>				<ul style="list-style-type: none"> • 30" long • 1 1/2" diameter • 1 1/2" wall clearance • Supports up to 500 lbs when properly installed • Meets ADA standards • Concealed mounting • Type 304 stainless steel • Grab bar - 18 gauge • 3" diameter flanges - 14 gauge • Snap lock covers - 20 gauge • Mounting hardware included
	40130-SS	3•	34.65	Brilliance® Stainless	
 	Commercial <i>ADA Grab Bar</i>				<ul style="list-style-type: none"> • 36" long • 1 1/2" diameter • 1 1/2" wall clearance • Supports up to 500 lbs when properly installed • Meets ADA standards • Concealed mounting • Type 304 stainless steel • Grab bar - 18 gauge • 3" diameter flanges - 14 gauge • Snap lock covers - 20 gauge • Mounting hardware included
	40136-PS	3•	50.75	Peened Stainless Steel	
	40136-SS	3•	35.95	Brilliance® Stainless	

	Model	Case	Price	Finish	Features
 	Commercial ADA Grab Bar				<ul style="list-style-type: none"> • 42" long • 1 1/2" diameter • 1 1/2" wall clearance • Supports up to 500 lbs when properly installed • Meets ADA standards • Concealed mounting • Type 304 stainless steel • Grab bar - 18 gauge • 3" diameter flanges - 14 gauge • Snap lock covers - 20 gauge • Mounting hardware included
	40142-PS	3•	55.75	Peened Stainless Steel	
	40142-SS	3•	38.90	Brilliance® Stainless	
 	Commercial ADA Grab Bar				<ul style="list-style-type: none"> • 48" long • 1 1/2" diameter • 1 1/2" wall clearance • Supports up to 500 lbs when properly installed • Meets ADA standards • Concealed mounting • Type 304 stainless steel • Grab bar - 18 gauge • 3" diameter flanges - 14 gauge • Snap lock covers - 20 gauge • Mounting hardware included
	40148-SS	3•	46.55	Brilliance® Stainless	
 	Commercial ADA Grab Bar				<ul style="list-style-type: none"> • 24" long • 1 1/4" diameter • 1 1/2" wall clearance • Supports up to 500 lbs when properly installed • Meets ADA standards • Concealed mounting • Type 304 stainless steel • Grab bar - 18 gauge • 3" diameter flanges - 14 gauge • Snap lock covers - 20 gauge • Mounting hardware included
	41124-SS	3•	26.70	Brilliance® Stainless	
	41124-ST	3•	38.80	Bright Stainless Steel	
 	Commercial ADA Grab Bar				<ul style="list-style-type: none"> • 30" long • 1 1/4" diameter • 1 1/2" wall clearance • Supports up to 500 lbs when properly installed • Meets ADA standards • Concealed mounting • Type 304 stainless steel • Grab bar - 18 gauge • 3" diameter flanges - 14 gauge • Snap lock covers - 20 gauge • Mounting hardware included
	41130-SS	3•	28.55	Brilliance® Stainless	

	Model	Case	Price	Finish	Features
 	Commercial ADA Grab Bar				<ul style="list-style-type: none"> • 36" long • 1 1/4" diameter • 1 1/2" wall clearance • Supports up to 500 lbs when properly installed • Meets ADA standards • Concealed mounting • Type 304 stainless steel • Grab bar - 18 gauge • 3" diameter flanges - 14 gauge • Snap lock covers - 20 gauge • Mounting hardware included
	41136-SS	3•	32.25	Brilliance® Stainless	
 	Commercial ADA Grab Bar				<ul style="list-style-type: none"> • 42" long • 1 1/4" diameter • 1 1/2" wall clearance • Supports up to 500 lbs when properly installed • Meets ADA standards • Concealed mounting • Type 304 stainless steel • Grab bar - 18 gauge • 3" diameter flanges - 14 gauge • Snap lock covers - 20 gauge • Mounting hardware included
	41142-SS	3•	35.40	Brilliance® Stainless	
 	Commercial ADA Grab Bar				<ul style="list-style-type: none"> • 18" long • 1 1/4" diameter • 1 1/2" wall clearance • Supports up to 500 lbs when properly installed • Meets ADA standards • Concealed mounting • Type 304 stainless steel • Grab bar - 18 gauge • 3 1/16" diameter decorative flanges - 14 gauge • Designer step style snap lock covers - 20 gauge • Mounting hardware included
	41218-SN 41218-ST	3• 3•	48.70 48.70	Satin Nickel Bright Stainless Steel	
 	Commercial ADA Grab Bar				<ul style="list-style-type: none"> • 24" long • 1 1/4" diameter • 1 1/2" wall clearance • Supports up to 500 lbs when properly installed • Meets ADA standards • Concealed mounting • Type 304 stainless steel • Grab bar - 18 gauge • 3 1/16" diameter decorative flanges - 14 gauge • Designer step style snap lock covers - 20 gauge • Mounting hardware included
	41224-SN	3•	54.30	Satin Nickel	













	Model	Case	Price	Finish	Features
  	Traditional  Focus Product <i>Decorative ADA Grab Bar</i>				<ul style="list-style-type: none"> • 12" decorative grab bar • 1 1/4" diameter • Extends 2 3/4" from wall • Concealed mounting • 3" diameter flanges • 1 1/2" wall clearance • Mounting hardware included • Grab bar wall anchor included • Supports up to 500 lbs when properly installed • Coordinates with Victorian[®], Cassidy[™], Linden[™] and Windemere[®]
	41612	3	93.00	Chrome	
	41612-CZ	3	134.85	Champagne Bronze [™]	
	41612-PN	3	116.25	Polished Nickel	
	41612-RB	3	134.85	Venetian Bronze [®]	
	41612-SS	3	116.25	Brilliance [®] Stainless	
  	Traditional  Focus Product <i>Decorative ADA Grab Bar</i>				<ul style="list-style-type: none"> • 18" decorative grab bar • 1 1/4" diameter • Extends 2 3/4" from wall • Concealed mounting • 3" diameter flanges • 1 1/2" wall clearance • Mounting hardware included • Grab bar wall anchor included • Supports up to 500 lbs when properly installed • Coordinates with Victorian[®], Cassidy[™], Linden[™] and Windemere[®]
	41618	3	99.00	Chrome	
	41618-CZ	3	143.55	Champagne Bronze [™]	
	41618-PN	3	123.75	Polished Nickel	
	41618-RB	3	143.55	Venetian Bronze [®]	
	41618-SS	3	123.75	Brilliance [®] Stainless	
  	Traditional  Focus Product <i>Decorative ADA Grab Bar</i>				<ul style="list-style-type: none"> • 24" decorative grab bar • 1 1/4" diameter • Extends 2 3/4" from wall • Concealed mounting • 3" diameter flanges • 1 1/2" wall clearance • Mounting hardware included • Grab bar wall anchor included • Supports up to 500 lbs when properly installed • Coordinates with Victorian[®], Cassidy[™], Linden[™] and Windemere[®]
	41624	3	109.00	Chrome	
	41624-CZ	3	158.05	Champagne Bronze [™]	
	41624-PN	3	136.25	Polished Nickel	
	41624-RB	3	158.05	Venetian Bronze [®]	
	41624-SS	3	136.25	Brilliance [®] Stainless	
  	Traditional  Focus Product <i>Decorative ADA Grab Bar</i>				<ul style="list-style-type: none"> • 36" decorative grab bar • 1 1/4" diameter • Extends 2 3/4" from wall • Concealed mounting • 3" diameter flanges • 1 1/2" wall clearance • Mounting hardware included Grab bar wall anchor included • Supports up to 500 lbs when properly installed • Coordinates with Victorian[®], Cassidy[™], Linden[™] and Windemere[®]
	41636	3	125.00	Chrome	
	41636-CZ	3	181.25	Champagne Bronze [™]	
	41636-PN	3	156.25	Polished Nickel	
	41636-RB	3	181.25	Venetian Bronze [®]	
	41636-SS	3	156.25	Brilliance [®] Stainless	

















	Model	Case	Price	Finish	Features
  	Transitional  Focus Product <i>Decorative ADA Grab Bar</i>				<ul style="list-style-type: none"> • 12" decorative grab bar • 1 1/4" diameter • Extends 2 3/4" from wall • Concealed mounting • 3" diameter flanges • 1 1/2" wall clearance • Mounting hardware included • Grab bar wall anchor included • Supports up to 500 lbs when properly installed • Coordinates with Addison™, Lahara®, Classic and Foundations®
	41712	3	93.00	Chrome	
	41712-CZ	3	134.85	Champagne Bronze™	
	41712-RB	3	134.85	Venetian Bronze®	
	41712-SS	3	116.25	Brilliance® Stainless	

  	Transitional  Focus Product <i>Decorative ADA Grab Bar</i>				<ul style="list-style-type: none"> • 18" decorative grab bar • 1 1/4" diameter • Extends 2 3/4" from wall • Concealed mounting • 3" diameter flanges • 1 1/2" wall clearance • Mounting hardware included • Grab bar wall anchor included • Supports up to 500 lbs when properly installed • Coordinates with Addison™, Lahara®, Classic and Foundations®
	41718	3	99.00	Chrome	
	41718-CZ	3	143.55	Champagne Bronze™	
	41718-RB	3	143.55	Venetian Bronze®	
	41718-SS	3	123.75	Brilliance® Stainless	

  	Transitional  Focus Product <i>Decorative ADA Grab Bar</i>				<ul style="list-style-type: none"> • 24" decorative grab bar • 1 1/4" diameter • Extends 2 3/4" from wall • Concealed mounting • 3" diameter flanges • 1 1/2" wall clearance • Mounting hardware included • Grab bar wall anchor included • Supports up to 500 lbs when properly installed • Coordinates with Addison™, Lahara®, Classic and Foundations®
	41724	3	109.00	Chrome	
	41724-CZ	3	158.05	Champagne Bronze™	
	41724-RB	3	158.05	Venetian Bronze®	
	41724-SS	3	136.25	Brilliance® Stainless	

  	Transitional  Focus Product <i>Decorative ADA Grab Bar</i>				<ul style="list-style-type: none"> • 36" decorative grab bar • 1 1/4" diameter • Extends 2 3/4" from wall • Concealed mounting • 3" diameter flanges • 1 1/2" wall clearance • Mounting hardware included • Grab bar wall anchor included • Supports up to 500 lbs when properly installed • Coordinates with Addison™, Lahara®, Classic and Foundations®
	41736	3	125.00	Chrome	
	41736-CZ	3	181.25	Champagne Bronze™	
	41736-RB	3	181.25	Venetian Bronze®	
	41736-SS	3	156.25	Brilliance® Stainless	

	Model	Case	Price	Finish	Features
  	Contemporary ^{FP} Focus Product <i>Decorative ADA Grab Bar</i>				<ul style="list-style-type: none"> • 12" decorative grab bar • 1 1/4" diameter • Extends 2 3/4" from wall • Concealed mounting • 3" diameter flanges • 1 1/2" wall clearance • Mounting hardware included • Grab bar wall anchor included • Supports up to 500 lbs when properly installed • Coordinates with Tesla[®], Compel[®] and Trinsic[®]
	41812	3	93.00	Chrome	
	41812-CZ	3	134.85	Champagne Bronze™	
	41812-RB	3	134.85	Venetian Bronze [®]	
	41812-SS	3	116.25	Brilliance [®] Stainless	
  	Contemporary ^{FP} Focus Product <i>Decorative ADA Grab Bar</i>				<ul style="list-style-type: none"> • 18" decorative grab bar • 1 1/4" diameter • Extends 2 3/4" from wall • Concealed mounting • 3" diameter flanges • 1 1/2" wall clearance • Mounting hardware included • Grab bar wall anchor included • Supports up to 500 lbs when properly installed • Coordinates with Tesla[®], Compel[®] and Trinsic[®]
	41818	3	99.00	Chrome	
	41818-CZ	3	143.55	Champagne Bronze™	
	41818-RB	3	143.55	Venetian Bronze [®]	
	41818-SS	3	123.75	Brilliance [®] Stainless	
  	Contemporary ^{FP} Focus Product <i>Decorative ADA Grab Bar</i>				<ul style="list-style-type: none"> • 24" decorative grab bar • 1 1/4" diameter • Extends 2 3/4" from wall • Concealed mounting • 3" diameter flanges • 1 1/2" wall clearance • Mounting hardware included • Grab bar wall anchor included • Supports up to 500 lbs when properly installed • Coordinates with Tesla[®], Compel[®] and Trinsic[®]
	41824	3	109.00	Chrome	
	41824-CZ	3	158.05	Champagne Bronze™	
	41824-RB	3	158.05	Venetian Bronze [®]	
	41824-SS	3	136.25	Brilliance [®] Stainless	
  	Contemporary ^{FP} Focus Product <i>Decorative ADA Grab Bar</i>				<ul style="list-style-type: none"> • 36" decorative grab bar • 1 1/4" diameter • Extends 2 3/4" from wall • Concealed mounting • 3" diameter flanges • 1 1/2" wall clearance • Mounting hardware included • Grab bar wall anchor included • Supports up to 500 lbs when properly installed • Coordinates with Tesla[®], Compel[®] and Trinsic[®]
	41836	3	125.00	Chrome	
	41836-CZ	3	181.25	Champagne Bronze™	
	41836-RB	3	181.25	Venetian Bronze [®]	
	41836-SS	3	156.25	Brilliance [®] Stainless	

	Model	Case	Price	Finish	Features
  	Angular Modern  Focus Product <i>Decorative ADA Grab Bar</i>				<ul style="list-style-type: none"> • 12" decorative grab bar • 1 1/4" width • Extends 2 3/4" from wall • Concealed mounting • 3" square flanges • 1 1/2" wall clearance • Mounting hardware included • Grab bar wall anchor included • Supports up to 500 lbs when properly installed • Coordinates with Zura™, Vero™, Dryden™, Ara™ and Ashlyn®
	41912	3	93.00	Chrome	
	41912-CZ	3	134.85	Champagne Bronze™	
	41912-PN	3	116.25	Polished Nickel	
	41912-RB	3	134.85	Venetian Bronze®	
	41912-SS	3	116.25	Brilliance® Stainless	
  	Angular Modern  Focus Product <i>Decorative ADA Grab Bar</i>				<ul style="list-style-type: none"> • 18" decorative grab bar • 1 1/4" width • Extends 2 3/4" from wall • Concealed mounting • 3" square flanges • 1 1/2" wall clearance • Mounting hardware included • Grab bar wall anchor included • Supports up to 500 lbs when properly installed • Coordinates with Zura™, Vero™, Dryden™, Ara™ and Ashlyn®
	41918	3	99.00	Chrome	
	41918-CZ	3	143.55	Champagne Bronze™	
	41918-PN	3	123.75	Polished Nickel	
	41918-RB	3	143.55	Venetian Bronze®	
	41918-SS	3	123.75	Brilliance® Stainless	
  	Angular Modern  Focus Product <i>Decorative ADA Grab Bar</i>				<ul style="list-style-type: none"> • 24" decorative grab bar • 1 1/4" width • Extends 2 3/4" from wall • Concealed mounting • 3" square flanges • 1 1/2" wall clearance • Mounting hardware included • Grab bar wall anchor included • Supports up to 500 lbs when properly installed • Coordinates with Zura™, Vero™, Dryden™, Ara™ and Ashlyn®
	41924	3	109.00	Chrome	
	41924-CZ	3	158.05	Champagne Bronze™	
	41924-PN	3	136.25	Polished Nickel	
	41924-RB	3	158.05	Venetian Bronze®	
	41924-SS	3	136.25	Brilliance® Stainless	
  	Angular Modern  Focus Product <i>Decorative ADA Grab Bar</i>				<ul style="list-style-type: none"> • 36" decorative grab bar • 1 1/4" width • Extends 2 3/4" from wall • Concealed mounting • 3" square flanges • 1 1/2" wall clearance • Mounting hardware included Grab bar wall anchor included • Supports up to 500 lbs when properly installed • Coordinates with Zura™, Vero™, Dryden™, Ara™ and Ashlyn®
	41936	3	125.00	Chrome	
	41936-CZ	3	181.25	Champagne Bronze™	
	41936-PN	3	156.25	Polished Nickel	
	41936-RB	3	181.25	Venetian Bronze®	
	41936-SS	3	156.25	Brilliance® Stainless	

Model	Case	Price	Finish	Features
-------	------	-------	--------	----------



Commercial
Recessed Towel Dispenser and Waste Receptacle

45569-SS	1	524.65	Brilliance® Stainless
----------	---	--------	-----------------------

- Stainless steel recessed towel dispenser and waste receptacle
- Holds 800 multi-fold, 600 C-fold, or 1,100 single-fold towels
- Unit 304 satin stainless steel
- Seamless door – 18 gauge
- Cabinet – 26 gauge
- Plastic inner container
- 5 1/2" gallon capacity
- Includes tumbler locks and key
- Mounting hardware included
- Overall size 13" x 55 1/8"



Commercial
Recessed Towel Dispenser and Waste Receptacle

45568-SS	1	245.25	Brilliance® Stainless
----------	---	--------	-----------------------

- Stainless steel recessed towel dispenser and waste receptacle
- Holds 475 multi-fold or 350 C-fold towels
- Removable 2 gallon waste receptacle
- Unit 304 Stainless Steel – 22 gauge
- Includes tumbler lock and key
- Overall size 14" x 28"



Commercial
Towel Dispenser

45700-SS	6	80.35	Brilliance® Stainless
----------	---	-------	-----------------------

- Stainless steel multi-fold/C-fold towel dispenser
- Holds 525 multi-fold or 400 C-fold towels
- Unit 304 satin stainless steel – 22 gauge
- Refill side indicator slot
- Includes tumbler lock and key
- Mounting hardware included



Commercial
Sanitary Napkin Receptacle

48100-SS	12	50.35	Brilliance® Stainless
----------	----	-------	-----------------------

- Stainless steel sanitary napkin receptacle
- Unit 304 Stainless Steel - 26 gauge
- Flip top lid
- Overall size 8" x 11"

Model Case Price Finish Features



Commercial
Liquid Soap Dispenser

44000 1 58.50 Chrome

- Brass basin mounted liquid soap dispenser
- 32 oz. capacity polyethylene container
- 4" spout
- Adjust up to 3" max. counter thickness
- Mounting hardware included



Commercial
Liquid Soap Dispenser

44081 1 59.70 Chrome

- Stainless steel horizontal liquid soap dispenser
- 40 oz. capacity
- Shut-off soap valve
- View level indicator
- Mounting hardware included



Commercial
Liquid Soap Dispenser

44080-SS 24 59.70 Brilliance® Stainless

- Stainless steel vertical liquid soap dispenser
- 40 oz. capacity
- Shut-off soap valve
- View level indicator
- Mounting hardware included



Commercial
Spare Roll Paper Holder

45371-SS 6 96.70 Brilliance® Stainless



- Stainless steel surface spare roll paper holder
- Dispenses two 1,500 sheet rolls
- Stainless steel
- Includes tumbler lock and key
- Plastic rollers
- Overall size 5 3/4" x 10 3/4"









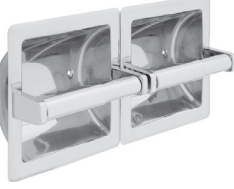



Commercial
Toilet Seat Cover Cabinet

49000-SS 6 53.05 Brilliance® Stainless

- Stainless steel toilet seat cover cabinet
- 500 seat cover capacity
- Unit 304 satin stainless steel
- Cabinet – 22 gauge
- Mounting hardware included
- Overall size 15 3/4" x 11"

	Model	Case	Price	Finish	Features
	Commercial <i>Recessed Paper Holder</i>				<ul style="list-style-type: none"> • Stainless steel recessed paper holder with plastic roller • Polished stainless steel shell • Plastic spring activated roller • Overall size 6 1/4" x 6 1/4"
	45070-ST	30	15.80	Bright Stainless Steel	
	Commercial <i>Recessed Extra Roll Paper Holder</i>				<ul style="list-style-type: none"> • Stainless steel recessed extra roll paper holder • Plastic spring activated roller • Spare roll stored in back • Recessed box - 25 gauge galvanized steel • Overall size 6 7/16" x 6 7/16"
	45470-ST	10	23.80	Bright Stainless Steel	
	Commercial <i>Recessed Paper Holder</i>				<ul style="list-style-type: none"> • Brass recessed paper holder with brass roller • Solid brass shell • Brass spring activated roller • Beveled edges • Overall size 6 1/4" x 6 1/4"
	45072	4	36.35	Chrome	
	Commercial <i>Recessed Twin Paper Holder</i>				<ul style="list-style-type: none"> • Stainless steel recessed twin paper holder, bright stainless • Polished stainless steel frame - 14 gauge • Plastic spring activated rollers • Horizontal mounting • Overall size 12 5/8" x 6 1/4"
	44970-ST	10	34.70	Bright Stainless Steel	



	Model	Case	Price	Finish	Features	
	Commercial <i>Twin Paper Holder</i>	45270	8	22.70	Chrome	<ul style="list-style-type: none"> • Twin paper holder with 2 plastic rollers • Chrome-plated zamak posts • Plastic spring activated rollers • Horizontal Mounting • Overall size 13 1/2" x 2"
	Commercial <i>Twin Paper Holder</i>	45272	8	26.75	Chrome	<ul style="list-style-type: none"> • Twin paper holder with two brass rollers • Chrome-plated zamak posts • Brass spring activated rollers • Horizontal mounting • Overall size 13 1/2" x 2"
	Commercial <i>Double Roll Deluxe Paper Holder</i>	45362	6	24.25	Chrome	<ul style="list-style-type: none"> • Double roll deluxe paper holder • Concealed push button hinge release • Heavy-duty chrome-plated zamak • Spring cabinets - 22 gauge galvanized steel • Overall size 10 7/16" x 2 7/16"
	Commercial <i>Recessed Vanity Tissue Cabinet</i>	46090	10	13.00	Chrome	<ul style="list-style-type: none"> • Galvanized steel recessed vanity tissue cabinet • For use when no tissue cover is required • Spring loaded for easy tissue box replacement • Recessed box and door – 23 gauge galvanized steel • Overall size 11 3/4" x 5 1/4" x 2 1/8"
	Commercial <i>Recessed Wall Clamp</i>	RP71072	1	7.05	Chrome	<ul style="list-style-type: none"> • Recessed wall clamp • For conventional type installations • Use when backing/framing is not available • Use for chrome and stainless steel recessed items • Steel bracket - 20 gauge • Zinc plated

	Model	Case	Price	Finish	Features
	Commercial Towel Shelf 43018	3	119.05	Chrome	<ul style="list-style-type: none"> • 18" towel shelf with one bar • Stainless steel • Concealed mounting • Shelf and towel bar tubing – 3/4" brass • Wall flange – 17 gauge brass • Mounting hardware included
	Commercial Towel Shelf 43024	3	128.75	Chrome	<ul style="list-style-type: none"> • 24" brass towel shelf with one bar • Stainless steel • Concealed mounting • Shelf and towel bar tubing – 3/4" stainless steel • Wall flange – 17 gauge stamped stainless steel • Mounting hardware included
	Commercial Towel Shelf 43224-SN	3	140.05	Satin Nickel	<ul style="list-style-type: none"> • 24" towel shelf with one bar • Stainless steel • Concealed mounting • Decorative beveled flanges • Shelf and towel bar tubing – 3/4" brass • Seamless drawn tubing • Mounting hardware included
	Commercial Towel Shelf 43424	3	147.05	Chrome	<ul style="list-style-type: none"> • 24" towel shelf with two bars • Stainless steel • Concealed mounting • Wall flange – 17 gauge brass • Shelf and towel bar tubing – 3/4" brass • Mounting hardware included
	Commercial Towel Shelf 43618-ST	3	71.75	Bright Stainless Steel	<ul style="list-style-type: none"> • 18" stainless steel towel shelf with one bar • Stainless steel • Exposed mounting • Pre-assembled • Shelf and towel bar tubing – 3/4" 304 stainless steel

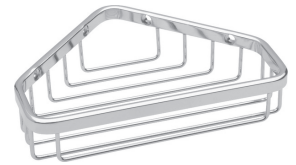
	Model	Case	Price	Finish	Features
	Commercial Towel Shelf				<ul style="list-style-type: none"> • 24" stainless steel towel shelf with one bar • Stainless steel • Exposed mounting • Pre-assembled • Shelf and towel bar tubing – 3/4" 304 stainless steel
	43624-SN	3	80.95	Satin Nickel	
	43624-ST	3	74.20	Bright Stainless Steel	

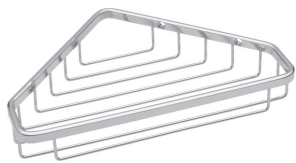
	Commercial Small Corner Caddy				<ul style="list-style-type: none"> • Stainless steel small corner caddy • Mounting hardware included • Overall size 6 9/32" x 5 3/32"
	47000-ST	12	18.45	Bright Stainless Steel	

	Commercial Large Corner Caddy				<ul style="list-style-type: none"> • Stainless steel large corner caddy • Mounting hardware included • Overall size 9 9/32" x 6 9/32"
	47100-ST	12	22.45	Bright Stainless Steel	

	Model	Case	Price	Finish	Features
	Commercial Shower Rod				<ul style="list-style-type: none"> • Stainless steel rod • 6' long • 1 1/4" diameter • Concealed mounting • 304 polished stainless steel • 3" wall flanges - 14 gauge • Snap lock cover flanges - 20 gauge
	42006-ST	3•	52.95	Bright Stainless Steel	
	Commercial Curved Shower Rod				<ul style="list-style-type: none"> • Adjustable shower rod • 5' long • 1" diameter • Concealed mounting • 6" bow • 304 stainless steel tubing • Oval design prevents rotation and wet floors • Solid brass spring pin design replaces set screw • Eliminates need to tighten product • Mounting hardware included
	42205-SS	3•	35.90	Brilliance® Stainless	
	42205-ST	3•	37.60	Bright Stainless Steel	
	Commercial Curved Shower Rod				<ul style="list-style-type: none"> • Adjustable shower rod • 6' long • 1" diameter • Concealed mounting • 6" bow • 304 stainless steel tubing • Oval design prevents rotation and wet floors • Solid brass spring pin design replaces set screw • Eliminates need to tighten product • Mounting hardware included
	42206-SS	3•	37.60	Brilliance® Stainless	
	42206-ST	3•	39.50	Bright Stainless Steel	

Model	Case	Price	Finish	Features
-------	------	-------	--------	----------



Commercial
Grid Strainer

- 1 1/4" grid strainer
- Cast brass body
- Overflow holes

33T260	1	21.50	Chrome
--------	---	-------	--------

For complete 33T series product offering, see page C119.



Commercial
Grid Strainer - Less Overflow Holes

- 1 1/4" grid strainer
- Cast brass body
- Less overflow holes

33T260-1	1	25.30	Chrome
----------	---	-------	--------



Commercial
Grid Strainer - Less Overflow Holes

- Hooded open grid strainer
- Cast brass body
- Removable hooded drain cover for splash reduction
- Less overflow holes

33T260-1DC	1	67.50	Chrome
------------	---	-------	--------



Commercial
Grid Strainer

- Offset grid strainer
- Cast brass body
- Overflow holes

33T290	20	40.40	Chrome
--------	----	-------	--------



Commercial
Grid Strainer - Less Overflow Holes

- Offset grid strainer
- Cast brass body
- Less overflow holes

33T290-1	20	44.35	Chrome
----------	----	-------	--------





Model	Case	Price	Finish	Features
-------	------	-------	--------	----------

Commercial
Grid Strainer - Less Overflow Holes

33T290-1DC	1	85.95	Chrome
------------	---	-------	--------

For complete 33T series product offering, see page C119.

- Hooded open offset grid strainer
- Cast brass body
- Removable hooded drain cover for splash reduction
- Less overflow holes



Commercial
Adjustable P-trap with Cleanout

33T311	12	48.15	Chrome
--------	----	-------	--------

- Adjustable P-trap with cleanout
- Cast brass waste bend
- Slip joint coupling nuts
- Deep, brass wall flange
- 1 1/4" size



Commercial
Adjustable P-trap with Cleanout

33T360	12	59.50	Chrome
--------	----	-------	--------

- Adjustable P-trap with cleanout
- Cast brass waste bend
- Slip joint coupling nuts
- Deep, brass wall flange
- 1 1/2" size



Model Options

Delta is known for its depth of commercial products that meet any project requirement. Part of our solution is having the flexibility to customize products – easily. This section of the price book utilizes our building block process, where you configure the product to your specific needs. It’s all up to you – cartridge, spout, outlet, handle – you select it, we build it. It doesn’t get any better and to top it off we continue to support you by listing some of the most popular selling models within a series, along with a supplemental product list, rough-in, trim and add-on options. Delta has the solutions to meet your current and future needs.

See page C161 for model number and pricing

SPOUT GROUP NO.	SPOUT "ADD-ON" SUFFIX NO.	RIGID/SWIVEL SPOUT DESCRIPTION	"A"		"C"		"L"		PRICE (ADD ON TO REGULAR GOOSENECK FAUCET PRODUCT PRICE)
			MM	IN.	MM	IN.	MM	IN.	
1	R2	Gooseneck Spout	114	4.5	104	4.1	170	6.7	5.35
	R3	Gooseneck Spout	152	6	124	4.9	56	2.2	6.80
	R4	Gooseneck Spout	152	6	124	4.9	146	5.8	5.35
	R5	Gooseneck Spout	152	6	124	4.9	188	7.4	6.80
	R6	Gooseneck Spout	152	6	124	4.9	229	9	10.25
	R7	Gooseneck Spout	229	9	163	6.4	170	6.7	24.20
	R35	Gooseneck Spout	152	6	124	4.9	94	3.7	5.35
2	R2	Gooseneck Spout w/Flow control***	114	4.5	97	3.8	178	7	5.35
	R3	Gooseneck Spout w/Flow control***	152	6	117	4.6	64	2.5	6.80
	R4	Gooseneck Spout w/Flow control***	152	6	117	4.6	152	6	5.35
	R5	Gooseneck Spout w/Flow control***	152	6	117	4.6	196	7.7	6.80
	R6	Gooseneck Spout w/Flow control***	152	6	117	4.6	236	9.3	10.25
	R7	Gooseneck Spout w/Flow control***	229	9	155	6.1	178	7	24.20
	R35	Gooseneck Spout w/Flow control***	152	6	117	4.6	102	4	5.35
3	R17†	Double Joint Spout	359	14.1	38	1.5	218	8.6	65.60

***Must be ordered with Outlet Option #7 or 8.

†Swing spout portion of R17 is brass tubular wall spout. This optional spout is NOT Watersense® applicable. ALL other gooseneck spouts are made from .09" heavy wall **seamless brass pipe**.

PROCEDURE to PRICE and ORDER a complete faucet with one of the above "OPTIONAL SPOUTS".

(1) **START** with the **BASE PRODUCT** (which ALWAYS includes the **STANDARD gooseneck spout**)

(2) **ADD OPTIONAL SUFFIX** if required

(3) **ADD** the **OPTIONAL SPOUT** selected (from the above list)

PRICING:

E.G.	(1) (2) BASE PRODUCT PRICE	PLUS	(3) OPTIONAL SPOUT ADD-ON PRICE	EQUALS	(4) OPTIONAL SPOUT PRODUCT PRICE
e.g. 1	23C644 - LS 287.90	+	R4 5.35	=	23C644 - LS - R4 293.25

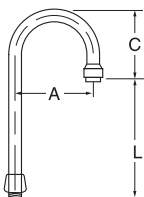

GROUP NO. 1
Regular
Gooseneck

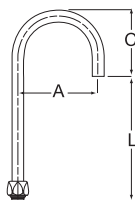

GROUP NO. 2
Smooth End-Flow Control In
Base of Gooseneck Spout
(Available on #7 outlets ONLY)

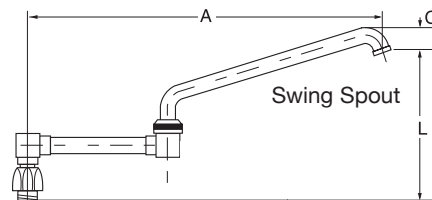

GROUP NO. 3 Double Joint

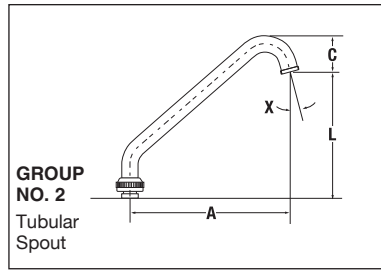
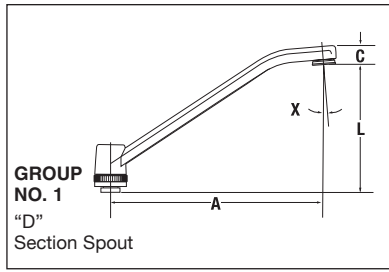

See page C162 for model number and pricing

SPOUT GROUP NO.	SPOUT SUFFIX NUMBER	SWING SPOUT DESCRIPTION	"X" DEGREES	"A"		"C"		"L"		PRICE (ADD-ON TO REGULAR 8" TUBULAR SWING SPOUT FAUCET PRICE)
				MM	IN.	MM	IN.	MM	IN.	
1	S2	8" "D" Section Spout	5	206	8.1	15	0.6	130	5.1	33.00
	S3	6" Tubular Spout	15	140	5.5	38	1.5	107	4.2	4.65
2	S5	8" Tubular Spout	15	185	7.3	41	1.6	147	5.8	4.60
	S7	11" Tubular Spout	16.5	277	10.9	28	1.1	104	4.1	8.55
	S8	14" Tubular Spout	16.5	351	13.8	28	1.1	127	5	13.15

Note: Measurements may vary plus or minus 6 mm (0.25")

E.G.	(1) BASE PRODUCT PRICE	PLUS	(2) OPTIONAL SPOUT ADD-ON PRICE	EQUALS	(3) OPTIONAL SPOUT PRODUCT PRICE
e.g. 1	26C3243 214.55	+	S7 8.55	=	26C3243-S7 223.10
e.g. 2	28C4243 247.05	+	S3 4.65	=	28C4243-S3 251.70

SPECIFYING PROCEDURE FOR OPTIONAL SWING SPOUTS:

1. Select **BASE PRODUCT** with Standard 8" Tubular Swing Spout and with spout outlet and handles required.
2. Select **Optional Swing Spout S** ("ADD-ON" Suffix Number).
3. Attach S (No.) Swing Spout selected to Base Product as a Dash Suffix (-S).

HOW TO SELECT AND SPECIFY ADD-ON OPTIONS:

EG. 1 (1) Base Product Selected:	26C3243	EG. 2 (1) Base Product Selected:	28C4243
(2) Optional Spout selected:	S7	(2) Optional Spout selected:	S3
(9" tubular swing spout selected)		(6" wall form swing spout selected)	
(3) End Product Number to Specify:	26C3243-S7	(3) End Product Number to Specify:	28C4243-S3



T13H152



Model

* - Stock Item

- * T13H133
- * T13H152
- * T13H153
- * T13H163
- * T13H253

Price

- 106.85
- 279.55
- 279.55
- 237.65
- 299.85

Rough-in (Order Separately)

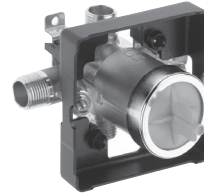

Rough-in for Tub & Shower with Stops

R10000-UNWS * 71.10

Note: Cartridge ships with trim

Trim

Choose trim required. See below. A number from each option column below must be used.

Example: T13H163

Tub/Shower

T13H To order trim, add the prices of chosen variations (listed below). A number from each option column must be used.

Note: Rough-in also required.

VARIATION	SHOWER		HANDLE	
	0	Specify "0" when no shower required (1)	0	0
Shower Valve Only 59.30	1		1	1
Tub and Shower 79.60	2	3-Function Touch-Clean® Showerhead, Arm & Set Screw Flange 60.10	2	26.80
	3	Showerhead, Arm & Set Screw Flange 20.75	3	26.80
	4		4	4
	5	Handshower with 2 Check Valves, 610 mm (24") S/S Bar with ADA Slide 193.45	5	5
	6	30° Vandal Resistant, Cast Flow Control Wallmount Showerhead 151.55	6	6
	7		7	7
	8	H ₂ Okinetic Technology® Showerhead, Arm & Set Screw Flange 50.60	8	8
	9		9	9

See price page C101 for "Add-On Options" pricing. See page C100 for Shower Valves with Diverter for Dual Showers.
 (1) Valve rated at minimum 1.25 gpm (4.7 L/min) for 13/14 series pressure balance; 1.5 gpm (5.7 L/min) for 17 series pressure balance; 2.0 gpm (7.6 L/min) for thermostatic at 45 psi (310 kPa). ASSE.1016/ASME.A112.1016/GSA.B125.16

DELTA COMMERCIAL TECHNICAL SERVICE 1-877-509-2680
 ONLINE CATALOGS: www.deltacommercialfaucets.com (Core products ONLY)
www.specselect.com (Complete Product Offering & Part Numbering System)



T13H332



Model

* - Stock Item

* T13H332

* T13H333

Price

440.70

440.70

Rough-in (Order Separately)

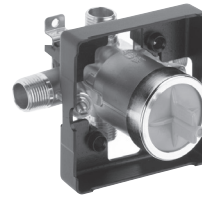

Rough-in for Tub & Shower with In-wall Diverter Valve (not shown) & with Stops

R10700-UNWS *

118.60

Note: Cartridge ships with trim

Trim

Choose trim required. See below. A number from each option column below must be used.

Example: T13H333

T13H To order trim, add the prices of chosen variations (listed below). A number from each option column must be used.

Note: Rough-in also required.

VARIATION	SHOWER	HANDLE
	0 Specify "0" when no shower outlet required (1)	0
	1	1
	2 3-Function Touch-Clean® Showerhead, Arm & Set Screw Flange 60.10	2 85 mm (3.33") Metal Lever Handle 26.80
Shower, Handshower with 2 Check Valves, Diverter Valve, 610 mm (24") S/S Bar with ADA Slide 393.15	3 Showerhead, Arm & Set Screw Flange 20.75	3 57 mm (2.24") Lever Blade Handle 26.80
	4	4
	5	5
	6 30° Vandal Resistant, Cast Flow Control Wallmount Showerhead 151.55	6
	7	7
	8 H ₂ Okinetic Technology® Showerhead, Arm & Set Screw Flange 50.60	8
Tub & Shower (Same as No. 3 above) but with Diverter Spout 436.15	9	9

See price page C101 for "Add-On Options" pricing. See page C99 for Shower Valves **less** Diverter for Dual Showers.



Product Variations 3 & 9 require selection of the second Showerhead from SHOWER Option No. 2, 3, 6 or 8.

(1) Valve rated at minimum 1.25 gpm (4.7 L/min) for 13/14 series pressure balance; 1.5 gpm (5.7 L/min) for 17 series pressure balance; 2.0 gpm (7.6 L/min) for thermostatic at 45 psi (310 kPa). ASSE.1016/ASME.A112.1016/CSA.B125.16

DELTA COMMERCIAL TECHNICAL SERVICE 1-877-509-2680
ONLINE CATALOGS: www.deltacommercialfaucets.com (Core products ONLY)
www.specselect.com (Complete Product Offering & Part Numbering System)

Price additions for Add-On Options:

- To complete an Add-On Option Product Price add the prices of the chosen variations (listed below). A number from the hose and slide bar columns must always be selected, even if it is "0".

HOSE		SLIDE BAR	
Always use "0" if No selection is required from this column	0	Always use "0" if No selection is required from this column	0
	1		1
1753 mm (69") Long CP Stainless Steel Hose (1) -stretches to 92"	2		2
 Add 32.55	3		3
	4		4
		 Add 17.15	5
		 914 mm (36") Combination S/S Slide Bar (2)	

Tub/Shower

Notes:

- (1) **Base Product** for the **HOSE, ETC.** options must be from **PRODUCT VARIATION TRIM No.'s 3 or 9** or must include **SHOWER** option **No. 5**
- (2) **Base Product** for **Slide Bar** must be from **PRODUCT VARIATION TRIM No.'s 3 or 9**, or must include **SHOWER** option **No. 5**

HOW TO SELECT AND SPECIFY ADD-ON OPTIONS:

Example No. 1: Base Product selected is R10700-UNWS Rough-in, and a T13H323 finish trim with an Add-On Option of the 36" S/S Slide Bar.
36" S/S Slide Bar Add-On Suffix Number is -05
Model Number to Specify: R10700-UNWS Rough-in and T13H323-05 Finish Trim

PRICING:

EXAMPLE	(1) BASE PRODUCT PRICE	PLUS	(2) ADD-ON OPTION NO. ADD-ON PRICE	EQUALS	(3) END MODEL NUMBER PRICE
No. 1	R10700-UNWS and T13H323 118.60 + 480.05	+	-05 ADD 17.15	=	R10700-UNWS and T13H323-05 615.80



Model

* - Stock Item
 * T17TH155

Price

526.70

Rough-in (Order Separately)

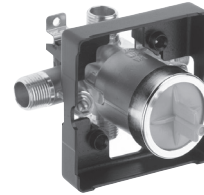

Rough-in for Tub & Shower with Stops

R10000-UNWS * 71.10

Note: Cartridge ships with trim

Trim

Choose trim required. See below. A number from each option column below must be used.

Example: T17TH155

T17TH To order trim, add the prices of chosen variations (listed below). A number from each option column must be used.

Note: Rough-in also required.

VARIATION	SHOWER		HANDLE	
	0	Specify "0" when no shower required (1)	0	0
Shower Valve only 306.45	1		1	1
Tub and Shower 326.75	2	3-Function Touch-Clean® Showerhead, Arm & Set Screw Flange 60.10	2	2
	3	Touch-Clean®, Showerhead, Arm & Set Screw Flange 20.75	3	3
	4		4	4
	5	<input checked="" type="checkbox"/> Handshower with 2 Check Valves, 610 mm (24") S/S Bar with ADA Slide 193.45	5	<input checked="" type="checkbox"/> Metal Lever Volume Control Handle w/Temperature Adjustment 26.80
	6		6	6
	7		7	7
	8		8	8
	9		9	9

See price page C104 for "Add-On Options" pricing. See page C103 for Shower Valves with Diverter for Dual Showers.
 (1) Valve rated at minimum 1.25 gpm (4.7 L/min) for 13/14 series pressure balance; 1.5 gpm (5.7 L/min) for 17 series pressure balance; 2.0 gpm (7.6 L/min) for thermostatic at 45 psi (310 kPa). ASSE.1016/ASME.A112.1016/GSA.B125.16

DELTA COMMERCIAL TECHNICAL SERVICE 1-877-509-2680
 ONLINE CATALOGS: www.deltacommercialfaucets.com (Core products ONLY)
www.specselect.com (Complete Product Offering & Part Numbering System)



T17TH335



Model

* - Stock Item

* T17TH335

Price

687.80

Rough-in (Order Separately)

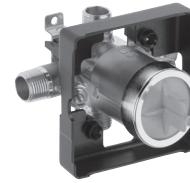

Rough-in for Tub & Shower with In-wall Diverter Valve (not shown) & with Stops

R10700-UNWS * 118.60

Note: Cartridge ships with trim

Trim

Choose trim required. See below. A number from each option column below must be used.

Example: T17TH335

Tub/Shower

T17TH To order trim, add the prices of chosen variations (listed below). A number from each option column must be used.

Note: Rough-in also required.

VARIATION	SHOWER		HANDLE	
	0	Specify "0" when no shower required (1)	0	0
	1		1	1
	2	3-Function Touch-Clean® Showerhead, Arm & Set Screw Flange 60.10	2	2
Shower, Handshower with 2 Check Valves, Diverter Valve, 610 mm (24") S/S Bar with ADA Slide 640.25	3	Touch-Clean®, Showerhead, Arm & Set Screw Flange 20.75	3	3
	4		4	4
	5		5	Metal Lever Volume Control Handle w/Temperature Adjustment 26.80
	6		6	6
	7		7	7
	8		8	8
Tub & Shower (Same as No. 3 above) but with Diverter Spout 683.25	9		9	9

See price page C104 for "Add-On Options" pricing. See page C102 for Shower Valves **less** Diverter for Dual Showers.

Product Variations 3 & 9 require selection of the second Showerhead from SHOWER **Option No. 2 or 3.**



(1) Valve rated at minimum 1.25 gpm (4.7 L/min) for 13/14 series pressure balance; 1.5 gpm (5.7 L/min) for 17 series pressure balance; 2.0 gpm (7.6 L/min) for thermostatic at 45 psi (310 kPa). ASSE.1016/ASME.A112.1016/CSA.B125.16

DELTA COMMERCIAL TECHNICAL SERVICE 1-877-509-2680
ONLINE CATALOGS: www.deltacommercialfaucets.com (Core products ONLY)
www.specselect.com (Complete Product Offering & Part Numbering System)

Price additions for Add-On Options:

To complete an Add-On Option Product Price add the prices of the chosen variations (listed below). A number from each option column must be used.

Tub/Shower

HOSE		SLIDE BAR	
Always use "0" if No selection is required from this column	0	Always use "0" if No selection is required from this column	0
	1		1
1753 mm (69") Long CP Stainless Steel Hose (1) -stretches to 92"	 Add 32.55		2
	3		3
	4		4
		 Add 17.15	5
		914 mm (36") S/S Slide Bar (2)	

Notes:

- (1) **Base Product** for the **HOSE, ETC.** options must be from **PRODUCT VARIATION TRIM No.'s 3 or 9** or must include **SHOWER** option **No. 5**
- (2) **Base Product** for **Slide Bar** must be from **PRODUCT VARIATION TRIM No.'s 3 or 9**, or must include **SHOWER** option **No. 5**

HOW TO SELECT AND SPECIFY ADD-ON OPTIONS:

Example No. 1: Base Product selected is R10700-UNWS Rough-in, and a T17TH325 with 36" S/S Slide Bar. 36" S/S Slide Bar Add-On Suffix Number is -05
Model Number to Specify: R10700-UNWS Rough-in and T17TH325-05 Trim

PRICING:

EXAMPLE	(1) BASE PRODUCT PRICE	PLUS	(2) ADD-ON OPTION NO. ADD-ON PRICE	EQUALS	(3) END MODEL NUMBER PRICE
No. 1	R10700-UNWS and T17TH325 118.60 + 727.15	+	-05 ADD 17.15	=	R10700-UNWS and T17TH325-05 862.90



Model

* - Stock Item

	* 21C132	166.45
	* 21C133	165.15
	* 21C134	184.35
	* 21C142	162.85
	* 21C143	161.55
	* 21C144	180.75
	* 21C153	174.45
	21C542	166.15

Price

ADD-ON "-TI" SUFFIX (ADD THE SUFFIX TO THE END OF THE MODEL NUMBER TO CHOOSE THIS OPTION)		
SUFFIX NUMBER	DESCRIPTION	ADD-ON TO PRICE
-TI	Handle Temperature Indicators "H" (red), "C" (blue) Available on handle options 2, 3 or 4 only	10.90

21C144



Code compliant applies to entire series.

CER-TECK® 21 C To complete a Product Price add the prices of chosen variations (listed below).
A number from each option column must be used.

BASIC PRODUCT		OUTLET		HANDLES	
	0		0		0
Standard Product Less Pop-up (No Pop-up Hole) 124.95	1		1	5 Fluted 24.90	1
Standard Product With Metal Pop-up 179.30	2	Vandal Resistant 1.5 gpm (5.7 L/min.) Laminar w/Agion® Antimicrobial 24.10	2	102 mm (4") Hooded Blade Handle 26.70	2
Standard Product with Cast Open Grid Strainer (No Pop-up Hole) 149.45	3	Vandal Resistant 1.5 gpm (5.7 L/min.) Flow Control Aerator 14.80	3	76 mm (3") Hooded Lever 25.40	3
Standard Product With Cast ADA Offset Open Grid Strainer (No Pop-up Hole) 169.95	4	Standard 1.5 gpm (5.7 L/min.) Flow Control Aerator 11.20	4	102 mm (4") Blade with Sanitary Hood 44.60	4
Standard Product With Chain Stay (For Plug & Chain) 128.25	5	Vandal Resistant 0.5 gpm (1.9 L/min.) Non-Aerating Spray Outlet 24.10	5	152 mm (6") Wrist with Sanitary Hood 71.55	5
	6		6		6
	7		7		7
	8		8	Self-Closing Hooded Lever Both Sides 53.85	8
	9	Vandal Resistant 0.35 gpm (1.32 L/min.) Non-Aerating Spray Outlet 24.10	9	Self-Closing 5-Fluted Both Sides 53.85	9

Flow rates are at 60 PSI (414 kPa)

Lavatory



Model

Price

*- Stock Item

*	22C101	164.75
*	22C131	166.65
*	22C151	175.95
*	22C301	194.90
*	22C401	184.75
*	22C601	182.25
*	22C801	215.80

22C101



Code compliant applies to entire series.

22C **1** To complete a Product Price add the prices of chosen variations (listed below).
A number from each option column must be used.

Lavatory

PRODUCT VARIATION		OUTLET		HANDLE	
102 mm (4") Centerset Less Pop-up (With Pop-up Hole)	146.00	0	Vandal Resistant Outlet (Wrench Flats) 1.5 gpm (5.7 L/min.)	0	
102 mm (4") Centerset Less Pop-up (No Pop-up Hole)	134.00	1		1	89 mm (3 1/2") ADA Compliant Lever Handle 17.85
		2	Vandal Resistant 1.5 gpm (5.7 L/min.) Laminar w/Agion® Antimicrobial	2	
102 mm (4") Centerset With Metal Pop-Up	164.15	3	Vandal Resistant 1.5 gpm (5.7 L/min.) Flow Control Aerator	3	
102 mm (4") Centerset With Open Grid Strainer (No Pop-up Hole)	154.00	4	Standard 1.5 gpm (5.7 L/min.) Flow Control Aerator	4	
102 mm (4") Centerset with ADA Offset Open Grid Strainer (No Pop-up Hole)	171.50	5	Vandal Resistant 0.5 gpm (1.9 L/min.) Non-Aerating Spray Outlet	5	
Single Hole Mount Less Pop-up (No Pop-up Hole)	151.50	6		6	
		7		7	
Single Hole Mount With Metal Pop-Up	185.05	8		8	
Single Hole Mount with Open Grid Strainer (No Pop-up Hole)	173.80	9	Vandal Resistant 0.35 gpm (1.32 L/min.) Non-Aerating Spray Outlet	9	

Flow rates are at 60 PSI (414 kPa)

DELTA COMMERCIAL TECHNICAL SERVICE 1-877-509-2680
 ONLINE CATALOGS: www.deltacommercialfaucets.com (Core products ONLY)
www.specselect.com (Complete Product Offering & Part Numbering System)



Model

- * - Stock Item
- * 23C1041
- 23C1049





Price

- 104.95
- 119.80

23C1041

Code compliant applies to entire series.

CER-TECK® 23 C 1 To complete a Product Price add the prices of chosen variations (listed below).
A number from each option column must be used.

BASIC PRODUCT		OUTLET		HANDLE	
Standard Single Basin Faucet Body	0 80.25		0		0
	1		1	5 Fluted 	1 13.50
	2		2		2
	3		3	 70 mm (2¾") Lever Blade Handle	3 13.50
	4	Standard 1.5 gpm (5.7 L/min.) Flow Control Aerator 	4 11.20		4
	5		5		5
	6		6		6
	7		7		7
	8		8		8
	9		9	Self-Closing 5 Fluted 	9 28.35

Lavatory

Flow rates are at 60 PSI (414 kPa)

DELTA COMMERCIAL TECHNICAL SERVICE 1-877-509-2680
ONLINE CATALOGS: www.deltacommercialfaucets.com (Core products ONLY)
www.specselect.com (Complete Product Offering & Part Numbering System)



23C643



Model

* - Stock Item

- * 23C332
- * 23C333
- * 23C634
- * 23C642
- * 23C644

Price

- 264.20
- 262.90
- 263.90
- 242.40
- 260.30

ADD-ON "-LS" SUFFIX		
SUFFIX NUMBER	DESCRIPTION	ADD-ON TO PRICE
-LS	120° Limited Swing Gooseneck (Available on #6 Basic Product ONLY)	27.60

ADD-ON "-TI" SUFFIX		
SUFFIX NUMBER	DESCRIPTION	ADD-ON TO PRICE
-TI	Handle Temperature Indicators "H" (red), "C" (blue) Available on handle options 2, 3 or 4 only	10.90

Code compliant applies to entire series.

CER-TECK® 23 C

To complete a Product Price add the prices of chosen variations (listed below). A number from each option column must be used.

BASIC PRODUCT	OUTLET	HANDLES
0	0	0
1	1	1
2	Vandal Resistant 1.5 gpm (5.7 L/min.) Laminar w/Agion® Antimicrobial 24.10	102 mm (4") Hooded Blade Handle 26.70
Cast Spout Less Pop-up (No Pop-up Hole) 222.70	Vandal Resistant 1.5 gpm (5.7 L/min.) Flow Control Aerator 14.80	76 mm (3") Hooded Lever 25.40
4	Standard 1.5 gpm (5.7 L/min.) Flow Control Aerator 11.20	102 mm (4") Blade with Sanitary Hood 44.60
5	Vandal Resistant 0.5 gpm (1.9 L/min.) Non-Aerating Spray Outlet 24.10	152 mm (6") Wrist with Sanitary Hood 71.55
(Std is R2) Rigid/Swivel Inline Gooseneck Spout Less Pop-up 204.50	6	6
	Smooth End, Laminar Flow Control in Base of Gooseneck Spout 1.0 gpm (3.8 L/min.) (1) 24.10	7
	8	8
	9	9

See Page C97 for **Optional Rigid/Swivel Spouts**. These spouts can ONLY be added to **BASIC PRODUCT Option No.6**.

(1) This outlet can ONLY be added to **BASIC PRODUCT Option No.6**.

Flow rates are at 60 PSI (414 kPa)

DELTA COMMERCIAL TECHNICAL SERVICE 1-877-509-2680
 ONLINE CATALOGS: www.deltacommercialfaucets.com (Core products ONLY)
www.specselect.com (Complete Product Offering & Part Numbering System)



Model

	24T2623	307.35
	24T2633	298.05
	24T2643	294.45
	24T0003	188.60

Control Valve Only
Less Spout

Price

ADD-ON "-LS" SUFFIX		
SUFFIX NUMBER	DESCRIPTION	ADD-ON TO PRICE
-LS	120° Limited Swing Gooseneck	27.60

24T2643



Code compliant applies to entire series.

24 T 2 **6** **3**

To complete a Product Price add the prices of chosen variations (listed below).
A number from each option column must be used.

BASIC PRODUCT	OUTLET	HANDLES
0	0	0
1	1	1
2	Vandal Resistant 1.5 gpm (5.7 L/min.) Laminar w/Agion® Antimicrobial 24.10	2
3	Vandal Resistant 1.5 gpm (5.7 L/min.) Flow Control Aerator 14.80	3 152 mm (6") Lever Blade Handle 20.35
4	Standard 1.5 gpm (5.7 L/min.) Flow Control Aerator 11.20	4
5	Vandal Resistant 0.5 gpm (1.9 L/min.) Non-Aerating Spray Outlet 24.10	5
(Std is R2) Rigid/Swivel Gooseneck Spout Less Pop-up (No Pop-up Hole) 262.90	6	6
7	Smooth End, Laminar Flow Control in Base of Gooseneck Spout 24.10	7
8	8	8
9	9	9

Lavatory

See Page C97 for **Optional Rigid/Swivel Spouts**.

Flow rates are at 60 PSI (414 kPa)



25C3847



Model

* - Stock Item

* 25C3837

* 25C3847

25C3947

Price

242.80

239.20

239.20

ADD-ON "-LS" SUFFIX		
SUFFIX NUMBER	DESCRIPTION	ADD-ON TO PRICE
-LS	120° Limited Swing Gooseneck Available on #8 and #9 Spout ONLY	27.60

Code compliant applies to entire series.

CER-TECK® 25C3 **133.20 LESS COVER PLATE (BASIC PRODUCT PRICE)**

To complete a Product Price add the prices of chosen variations (listed below) to the **Basic Product Price**. A number from each option column must be used.

SPOUT		OUTLET		HANDLES	
	0		0		0
	1		1		1
	2	Vandal Resistant 1.5 gpm (5.7 L/min.) Laminar w/Agion® Antimicrobial	24.10	2	2
	3	Vandal Resistant 1.5 gpm (5.7 L/min.) Flow Control Aerator	14.80	3	3
	4	Standard 1.5 gpm (5.7 L/min.) Flow Control Aerator	11.20	4	4
	5	Vandal Resistant 0.5 gpm (1.9 L/min.) Non-Aerating Spray Outlet	24.10	5	5
	6			6	6
	7	Smooth End, Laminar Flow Control in Base of Gooseneck Spout 1.0 gpm (3.8 L/min.) (1)	24.10	63.5 mm (2½") Balanced Lever	30.95
(Std is R2) 114 mm (4½") Bend Rigid/Swivel Gooseneck Spout	63.85			8	8
(Std is R4) 152 mm (6") Bend Rigid/Swivel Gooseneck Spout	63.85			9	9

Sink Faucets

See Page C97 for **Optional Rigid/Swivel Spouts**. These spouts can ONLY be added to **SPOUT Option No. 9**.

(1) This outlet can ONLY be added to **SPOUT Option No.'s 8 or 9**.

Flow rates are at 60 PSI (414 kPa)

DELTA COMMERCIAL TECHNICAL SERVICE 1-877-509-2680
 ONLINE CATALOGS: www.deltacommercialfaucets.com (Core products ONLY)
www.specselect.com (Complete Product Offering & Part Numbering System)



26C3933



Model

- * - Stock Item
- 26C3132
- * 26C3133
- * 26C3143
- * 26C3232
- * 26C3233
- * 26C3932
- * 26C3933
- * 26C3934
- * 26C3944

Price

- 241.60
- 240.30
- 236.70
- 219.45
- 218.15
- 246.45
- 245.15
- 264.35
- 260.75

ADD-ON "-LS" SUFFIX		
SUFFIX NUMBER	DESCRIPTION	ADD-ON TO PRICE
-LS	120° Limited Swing Gooseneck Available on #9 Spout ONLY	27.60

ADD-ON "-TI" SUFFIX		
SUFFIX NUMBER	DESCRIPTION	ADD-ON TO PRICE
-TI	Handle Temperature Indicators "H" (red), "C" (blue) Available on handle options 2, 3 or 4 only	10.90

Code compliant applies to entire series.

CER-TECK® 26C3 To complete a Product Price add the prices of chosen variations (listed below). A number from each option column must be used.

SPOUT AND BASIC PRODUCT		OUTLET		HANDLES	
	0		0		0
(Std is S2) 203 mm (8") Wallform Swing Spout	200.10				
	1		1	5 Fluted	24.90
(Std is S5) 203 mm (8") Tubular Swing Spout	177.95			102 mm (4") Hooded Blade Handle	26.70
	2	Vandal Resistant 1.5 gpm (5.7 L/min.) Laminar w/Agion® Antimicrobial	24.10		
	3	Vandal Resistant 1.5 gpm (5.7 L/min.) Flow Control Aerator	14.80	76 mm (3") Hooded Lever	25.40
	4	Standard 1.5 gpm (5.7 L/min.) Flow Control Aerator	11.20	102 mm (4") Blade with Sanitary Hood	44.60
	5	Vandal Resistant 0.5 gpm (1.9 L/min.) Non-Aerating Spray Outlet	24.10	152 mm (6") Wrist with Sanitary Hood	71.55
	6				
	7	Smooth End, Laminar Flow Control in Base of Gooseneck Spout 1.0 gpm (3.8 L/min.) (1)	24.10		
	8				
(Std is R4) 152 mm (6") Bend Rigid/Swivel Gooseneck Spout	204.95				
	9				

Sink Faucets

See Page C97 for **Optional Rigid/Swivel Spouts**. These spouts can ONLY be added to **SPOUT AND BASIC PRODUCT Option No. 9**.
 See Page C98 for **Optional Swing Spouts**. These spouts can ONLY be added to **SPOUT AND BASIC PRODUCT Option No. 2**.
 (1) This outlet can ONLY be added to **SPOUT AND BASIC PRODUCT Option No. 9**.

Flow rates are at 60 PSI (414 kPa)

DELTA COMMERCIAL TECHNICAL SERVICE 1-877-509-2680
 ONLINE CATALOGS: www.deltacommercialfaucets.com (Core products ONLY)
www.specselect.com (Complete Product Offering & Part Numbering System)



27C2933



Model

* - Stock Item

27C2933

* 27C2942

* 27C2944

Price

241.35

239.05

256.95

ADD-ON "-LS" SUFFIX		
SUFFIX NUMBER	DESCRIPTION	ADD-ON TO PRICE
-LS	120° Limited Swing Gooseneck (Available on #9 Basic Product ONLY)	27.60

ADD-ON "-TI" SUFFIX		
SUFFIX NUMBER	DESCRIPTION	ADD-ON TO PRICE
-TI	Handle Temperature Indicators "H" (red), "C" (blue) Available on handle options 2, 3 or 4 only	10.90

Code compliant applies to entire series.

CER-TECK® 27C1 **252.70 WITH HOSE AND SPRAY (BASIC PRODUCT PRICE)**
CER-TECK® 27C2 **146.20 LESS HOSE AND SPRAY (BASIC PRODUCT PRICE)**

To complete a Product Price add the prices of chosen variations (listed below) to the **Basic Product Price**.
 A number from each option column must be used.

SPOUT		OUTLET		HANDLES	
	0		0		0
(Std is S2) 203 mm (8") Wallform Swing Spout	62.45 1		1		1
(Std is S5) 203 mm (8") Tubular Swing Spout	26.90 2	Vandal Resistant 1.5 gpm (5.7 L/min.) Laminar w/Agion® Antimicrobial	24.10 2	102 mm (4") Hooded Blade Handle	26.70 2
	3	Vandal Resistant 1.5 gpm (5.7 L/min.) Flow Control Aerator	14.80 3	76 mm (3") Hooded Lever	25.40 3
	4	Standard 1.5 gpm (5.7 L/min.) Flow Control Aerator	11.20 4	102 mm (4") Blade with Sanitary Hood	44.60 4
	5	Vandal Resistant 0.5 gpm (1.9 L/min.) Non-Aerating Spray Outlet	24.10 5	152 mm (6") Wrist with Sanitary Hood	71.55 5
	6		6		6
	7	Smooth End, Laminar Flow Control in Base of Gooseneck Spout 1.0 gpm (3.8 L/min.) (1)	24.10 7		7
	8		8		8
(Std is R4) 152 mm (6") Bend Rigid/Swivel Gooseneck Spout	54.95 9		9		9

See Page C97 for **Optional Rigid/Swivel Spouts**. These spouts can ONLY be added to **SPOUT AND BASIC PRODUCT Option No. 9**.

See Page C98 for **Optional Swing Spouts**. These spouts can ONLY be added to **SPOUT AND BASIC PRODUCT Option No. 2**.

(1) This outlet can ONLY be added to **SPOUT AND BASIC PRODUCT Option No. 9**.

Flow rates are at 60 PSI (414 kPa)

DELTA COMMERCIAL TECHNICAL SERVICE 1-877-509-2680
 ONLINE CATALOGS: www.deltacommercialfaucets.com (Core products ONLY)
www.specselect.com (Complete Product Offering & Part Numbering System)



27C4834



Model

* - Stock Item

- * 27C4832
- * 27C4834
- * 27C4842
- * 27C4843
- * 27C4844

Price

- 198.90
- 216.80
- 195.30
- 194.00
- 213.20

ADD-ON "-LS" SUFFIX		
SUFFIX NUMBER	DESCRIPTION	ADD-ON TO PRICE
-LS	120° Limited Swing Gooseneck (Available on #8 and #9 Spout ONLY)	27.60

ADD-ON "-TI" SUFFIX		
SUFFIX NUMBER	DESCRIPTION	ADD-ON TO PRICE
-TI	Handle Temperature Indicators "H" (red), "C" (blue) Available on handle options 2, 3 or 4 only	10.90

Code compliant applies to entire series.

CER-TECK® 27C4 **90.50 LESS POP-UP**

(BASIC PRODUCT PRICE)

To complete a Product Price add the prices of chosen variations (listed below) to the **Basic Product Price**.
A number from each option column must be used.

SPOUT		OUTLET		HANDLES	
	0		0		0
	1		1		1
(Std is S5) 203 mm (8") Tubular Swing Spout	27.35	2	Vandal Resistant 1.5 gpm (5.7 L/min.) Laminar w/Agion® Antimicrobial 24.10	2	102 mm (4") Hooded Blade Handle 26.70
(Std is S3) 152 mm (6") Tubular Swing Spout	27.35	3	Vandal Resistant 1.5 gpm (5.7 L/min.) Flow Control Aerator 14.80	3	76 mm (3") Hooded Lever 25.40
	4	4	Standard 1.5 gpm (5.7 L/min.) Flow Control Aerator 11.20	4	102 mm (4") Blade with Sanitary Hood 44.60
	5	5	Vandal Resistant 0.5 gpm (1.9 L/min.) Non-Aerating Spray Outlet 24.10	5	152 mm (6") Wrist with Sanitary Hood 71.55
	6		6		6
	7		7		7
(Std is R2) 114 mm (4 1/2") Bend Rigid/Swivel Gooseneck Spout	66.90		Smooth End, Laminar Flow Control in Base of Gooseneck Spout 1.0 gpm (3.8 L/min.) (1) 24.10		
	8		8		8
(Std is R4) 152 mm (6") Bend Rigid/Swivel Gooseneck Spout	66.90		9		9

See Page C97 for **Optional Rigid/Swivel Spouts**. These spouts can ONLY be added to **SPOUT AND BASIC PRODUCT Option No. 9**.

See Page C98 for **Optional Swing Spouts**. These spouts can ONLY be added to **SPOUT AND BASIC PRODUCT Option No. 2**.

(1) This outlet can ONLY be added to **SPOUT AND BASIC PRODUCT Option No. 9**.

Flow rates are at 60 PSI (414 kPa)

DELTA COMMERCIAL TECHNICAL SERVICE 1-877-509-2680
ONLINE CATALOGS: www.deltacommercialfaucets.com (Core products ONLY)
www.specselect.com (Complete Product Offering & Part Numbering System)



Model

* - Stock Item

* 27C643

Price

175.40

27C643



Code compliant applies to entire series.

CER-TECK® 27C To complete a Product Price add the prices of chosen variations (listed below).
A number from each option column must be used.

SPOUT		OUTLET		HANDLE	
	0		0		0
	1		1		1
	2		2		2
	3	Vandal Resistant 1.5 gpm (5.7 L/min.) Flow Control Aerator	14.80	76 mm (3") Hooded Lever	13.50
	4	Standard 1.5 gpm (5.7 L/min.) Flow Control Aerator	11.20		
	5	Vandal Resistant 0.5 gpm (1.9 L/min.) Non-Aerating Spray Outlet	24.10		
(Std is R2) 114 mm (4½") Bend Rigid/Swivel Gooseneck Spout	150.70				
	6		6		6
	7		7		7
	8		8	Self Closing Hooded Lever	28.35
	9		9		9

Sink Faucets

No Optional Spouts available on this series.

Flow rates are at 60 PSI (414 kPa)

DELTA COMMERCIAL TECHNICAL SERVICE 1-877-509-2680
ONLINE CATALOGS: www.deltacommercialfaucets.com (Core products ONLY)
www.specselect.com (Complete Product Offering & Part Numbering System)



28C2383



Model

- * - Stock Item
- 28C2383
- 28C2384

Price

- 357.55
- 376.75

ADD-ON OPTIONS (ORDER SEPARATELY)		
CATALOGUE NUMBER	DESCRIPTION	PRICE
* 28T910	Mop Holder	66.35
* 28T911	48" Hose and Stainless Steel Hanger	36.85

ADD-ON "-AC" SUFFIX		
SUFFIX NUMBER	DESCRIPTION	ADD-ON TO PRICE
-AC	5½" to 10½" Adjustable Centers (Not available with No. 9 Long Spout)	73.20

CER-TECK® 28C2 **200.75 (BASIC PRODUCT PRICE)**

To complete a Product Price add the prices of chosen variations (listed below) to the **Basic Product Price**.
A number from each option column must be used.

SPOUT		OUTLET		HANDLES	
140 mm (5½") Spout Plain	0 62.35		0		0
	1	Body Mounted Double Check Vacuum Breaker with Garden Hose End	1 116.20		1
	2		2		2
267 mm (10½") Spout with Adjustable Top/Bottom Brace	3 80.65		3		3 25.40
	4		4		4 44.60
	5		5		5 71.55
	6	Spout End Vacuum Breaker with Garden Hose End	6 42.15		6
	7		7		7
	8	Body Mounted Vacuum Breaker with Garden Hose End	8 50.75		8
406 mm (16") Spout with Bottom Fork Brace	9 177.85		9		9

†Distance from wall to spout outlet.

Sink Faucets



Model

* - Stock Item

- * 28C4243
- * 28C4433
- * 28C4443

Price

- 247.05
- 255.00
- 251.40

ADD-ON "-AC" SUFFIX		
SUFFIX NUMBER	DESCRIPTION	ADD-ON TO PRICE
-AC	5½" to 10½" Adjustable Centers	73.20

28C4443



Code compliant applies to entire series.

CER-TECK® 28C4 **183.85** **LESS** INTEGRAL STOPS **(BASIC PRODUCT PRICE)**
CER-TECK® 28C6 **212.45** **WITH** INTEGRAL CHECK STOPS **(BASIC PRODUCT PRICE)**

To complete a Product Price add the prices of chosen variations (listed below) to the **Basic Product Price**.
 A number from each option column must be used.

SPOUT		OUTLET		HANDLES	
	0		0		0
	1		1		1
(Std is S5) 203 mm (8") Tubular Swing Spout 26.60	2	Vandal Resistant 1.5 gpm (5.7 L/min.) Laminar w/Agion® Antimicrobial 24.10	2		2
	3	Vandal Resistant 1.5 gpm (5.7 L/min.) Flow Control Aerator 14.80	3	76 mm (3") Hooded Lever 25.40	3
(Std is S7) 279 mm (11") Tubular Swing Spout 30.95	4	Standard 1.5 gpm (5.7 L/min.) Flow Control Aerator 11.20	4	102 mm (4") Blade with Sanitary Hood 44.60	4
	5	Vandal Resistant 0.5 gpm (1.9 L/min.) Non-Aerating Spray Outlet 24.10	5		5
	6		6		6
	7		7		7
	8		8		8
(Std is R4) 152 mm (6") Bend Rigid/Swivel Gooseneck Spout 54.25	9		9		9

Sink Faucets

See Page C97 for **Optional Rigid/Swivel Spouts**. These spouts can ONLY be added to **SPOUT Option No. 9**.
 See Page C98 for **Optional Swing Spouts**. These spouts can ONLY be added to **SPOUT Option No. 2**.

Flow rates are at 60 PSI (414 kPa)

DELTA COMMERCIAL TECHNICAL SERVICE 1-877-509-2680
 ONLINE CATALOGS: www.deltacommercialfaucets.com (Core products ONLY)
www.specselect.com (Complete Product Offering & Part Numbering System)

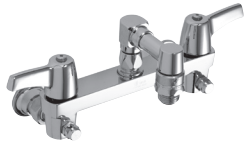

Model

* - Stock Item

- 28C8063
- * 28C8073
- 28C8083
- 28C8183

Price

- 315.05
- 341.95
- 323.65
- 341.95

ADD-ON OPTIONS (ORDER SEPARATELY)		
CATALOGUE NUMBER	DESCRIPTION	PRICE
* 28T910	Mop Holder	66.35
* 28T911	48" Hose and Stainless Steel Hanger	36.85





ADD-ON "-AC" SUFFIX (ADD THE SUFFIX TO THE END OF THE MODEL NUMBER TO CHOOSE THIS OPTION)		
SUFFIX NUMBER	DESCRIPTION	ADD-ON TO PRICE
-AC	5½" to 10½" Adjustable Centers	73.20

28C8063



CER-TECK® 28C8 **185.15 (BASIC PRODUCT PRICE)**

To complete a Product Price add the prices of chosen variations (listed below) to the **Basic Product Price**.
A number from each option column must be used.

SPOUT		OUTLET		HANDLES	
†140 mm (5½") Spout Plain  62.35	0		0		0
†203 mm (8") Spout with Top/Bottom Brace  80.65	1		1		1
	2		2		2
	3		3	 25.40 76 mm (3") Hooded Lever	3
	4		4		4
	5		5		5
	6	Spout End Vacuum Breaker with Garden Hose End  42.15	6		6
	7	Spout End Vacuum Breaker, 1219 mm (48") Hose and S/S Hanger 69.05	7		7
	8	Body Mounted Vacuum Breaker with Garden Hose End  50.75	8		8
	9		9		9

†Distance from wall to spout outlet.



COMPRESSION CARTRIDGE		
MODEL	DESCRIPTION	PRICE
28T9	Rough chrome plated with integral stops, pail hook and inline vacuum breaker, metal cross handles	* 164.70
28T9-AC	Same as 28T9 but with 5½" - 10½" (140 mm - 267 mm) adjustable centers	* 191.65

1/4 TURN CERAMIC CARTRIDGE		
MODEL	DESCRIPTION	PRICE
28C9LH	Rough chrome plated with integral stops, pail hook and inline vacuum breaker, 4" (102 mm) metal lever handles	* 206.90
28C9LH-AC	Same as 28C9LH but with 5½" - 10½" (140 mm - 267 mm) adjustable centers	* 233.90

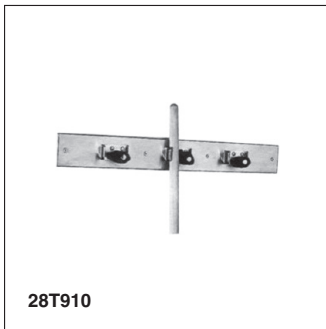

HOSE AND MOP HOLDER ACCESSORIES		
MODEL	DESCRIPTION	PRICE
28T910	Stainless steel mop hanger, 3" x 26" (76 mm x 660 mm) with 3 rubber grips	* 66.35
28T911	Stainless steel hanger bracket, 3" x 5" (76 mm x 127 mm) with rubber grip and 48" (1219 mm) hose	* 36.85

* - Stock Item



CAST LAVATORY WASTES					
MODEL	SIZE	DESCRIPTION	OVERFLOW HOLES		PRICE
			WITH	LESS	
* 33T260	1¼"	P.O. Plug with Open Grid Strainer – Chrome	✓		21.50
* 33T260-1	1¼"	As 33T260 less Overflow Holes – Chrome		✓	25.30
33T260-1DC	1¼"	As 33T260-1 but with Drain Cover		✓	67.50
* 33T290	1¼"	Offset P.O. with Open Grid Strainer – Chrome	✓		40.40
* 33T290-1	1¼"	As 33T290 less Overflow Holes – Chrome		✓	44.35
* 33T290-1DC	1¼"	As 33T290-1 but with Drain Cover (1)		✓	85.95
* 33T295	1¼"	Offset P.O. Plug with Chain & Stopper – Chrome	✓		44.35

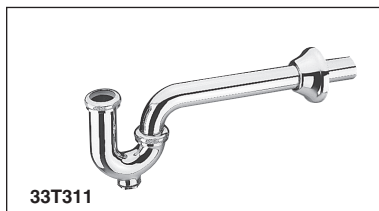

CAST P TRAPS				
MODEL	SIZE	LENGTH	DESCRIPTION	PRICE
* 33T301	1¼"	14½"	Cast P Traps Less Cleanout	46.85
* 33T311	1¼"	14½"	Cast P Traps With Cleanout	48.15
* 33T360	1½"	11½"	Cast P Traps With Cleanout	59.50

* – Stock Item



Model	Price
54T1104	374.85
54T1254	541.80

ADD-ON OPTIONS (ADD THE SUFFIX TO THE END OF THE MODEL NUMBER TO CHOOSE THIS OPTION)		
-SUFFIX NUMBER	DESCRIPTION	ADD-ON TO PRICE
-QD	Quick Disconnect Hose	71.15

54T1104



For 81TBP series water closet bedpan cleanser flush valves, see page C49.

- 54 T 1** Volume Control Valves
54 T 1 Volume Control Valves
54 T 1 **A** Foot Pedal Valves Only

To complete a Product Price add the prices of chosen variations (listed below).
 A number from each option column must be used.

BASIC PRODUCT		SPOUT		OUTLET	
	0	Use 0 in this column when Basic Product "1" specified	0		0
184.70	1			144.30	1
162.20	2				2
	3	238.40	3		3
595.85	4			190.15	4
	5	189.45	5		5
	6				6
	7				7
	8				8
	9				9

- (1) Check with local code authorities for proper cross-flow and hazard protection requirements.
 (2) When using self-close outlet #4, we recommend using #5 Vacuum Breaker Spout for continuous pressure.

DELTA COMMERCIAL TECHNICAL SERVICE 1-877-509-2680
 ONLINE CATALOGS: www.deltacommercialfaucets.com (Core products ONLY)
www.specselect.com (Complete Product Offering & Part Numbering System)



54T5432A



Model

- 54T5300A
- 54T5332A
- 54T5400A
- 54T5432A
- 54T5434A
- 54T2401
- 54T2402

Price

- 515.70
- 609.85
- 310.70
- 404.85
- 391.95
- 275.70
- 275.70

54T2401
8" Widespread Faucet with VR 1.5 gpm (5.7 L/min.) Laminar Outlet for 3rd Valve Connection (R2)

54T2402 Same as 54T2401, except with Smooth End Laminar Flow Control in Base of Gooseneck Spout 1.0 gpm (3.8 L/min.)

Code compliant applies to entire series.

54 T 5 **A** To complete a Product Price add the prices of chosen variations (listed below). A number from each option column must be used.

FOOT PEDAL VALVE		SPOUT		OUTLET	
	0	Select "0" if only pedal valve is required	0	Select "0" if only pedal valve is required	0
	1		1		1
	2	(Std is R2) Wallmount Rigid/Swivel Gooseneck 97.65	2	Vandal Resistant 1.5 gpm (5.7 L/min.) Laminar w/Agion® Antimicrobial 24.10	2
Wall Hung Double Pedal Valve with Inlet and Outlet Stops 515.70	3	(Std is R2) Deckmount Rigid/Swivel Gooseneck 70.05	3	Vandal Resistant 1.5 gpm (5.7 L/min.) Flow Control Aerator 14.80	3
Floor Mounted Double Pedal Valve 310.70	4		4	Standard 1.5 gpm (5.7 L/min.) Flow Control Aerator 11.20	4
	5		5		5
	6		6		6
	7		7	Smooth End, Laminar Flow Control in Base of Gooseneck Spout 1.0 gpm (3.8 L/min.) (1) 24.10	7
	8		8		8
	9		9		9

Surgeon Scrub-up

See Page C97 for **Optional Rigid/Swivel Spouts**. These spouts can ONLY be added to **SPOUT Option No.'s 2 or 3**, and **54T2401/54T2402** faucet.

Flow rates are at 60 PSI (414 kPa)

(1) This outlet can ONLY be added to **SPOUT Option No.'s 2 or 3**.



55C1513



Model	Price
55C1513	634.40
55P1000 0-12" Wall Bracket Only	48.10
55P1513 8" Wallmount Pre-Rinse LESS Wall Bracket and Thin Wall Kit	496.60



Code compliant applies to entire series.

ADD-ON OPTIONS (ORDER SEPARATELY)		
CATALOGUE NUMBER	DESCRIPTION	PRICE
55C1090	Add-On faucet (S5) (if ordered separately)	163.35

ADD-ON "-AC" SUFFIX		
SUFFIX NUMBER	DESCRIPTION	ADD-ON TO PRICE
-AC	5½" to 10½" Adjustable Centers	73.20

CER-TECK® 55C1

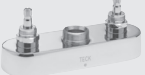
To complete a Product Price add the prices of chosen variations (listed below).
A number from each option column must be used.

BASIC PRODUCT		OUTLET		HANDLES	
	0		0		0
	1	Spray with Spring Loaded S.S. Hose Auto Shut-off	1		1
203 mm (8") Centre Deckmount Faucet, Check Tails  211.00	2		2		2
102 mm (4") Centre Deckmount Faucet, Check Tails  148.45	3		3	76 mm (3") Hooded Lever  25.40	3
	4		4		4
203 mm (8") Centre Wallmount Faucet, Check Stops  243.75	5		5		5
	6		6		6
	7		7		7
	8	Same as No. 1 Above but with Add-On Faucet,(S5) 1.5 gpm @ 60 psi (5.7 L/min. @ 414 kPa)	8		8
	9		9		9

See Page C98 for **Optional Swing Spouts**. These spouts can ONLY be added to **Outlet Option No. 8** and **55C1090**.
Standard spray is 1.6 gpm @ 60 psi (6 L/min. @ 414 kPa).
Optional 1.2 gpm @ 60 psi (4.5 L/min. @ 414 kPa) water and energy saver face plate also provided with 55C series models.

DELTA COMMERCIAL TECHNICAL SERVICE 1-877-509-2680
ONLINE CATALOGS: www.deltacommercialfaucets.com (Core products ONLY)
www.specselect.com (Complete Product Offering & Part Numbering System)



METERING FAUCETS (with 0.5 gpm (1.9 L/min.) Vandal Resistant Non-Aerating Spray Outlet)			
MODEL	DESCRIPTION		PRICE
87T104	Push Button Faucet	*	137.90
87T105	ADA Lever Handle Faucet	☐ *	147.50
87T110	Push Button Faucet with Mixing Tee	*	169.20
87T111	ADA Lever Handle Faucet with Mixing Tee	☐ *	179.45

METERING FAUCETS (with 0.35 gpm (1.32 L/min.) Vandal Resistant Non-Aerating Spray Outlet)			
MODEL	DESCRIPTION		PRICE
87T904	Push Button Faucet		137.90
87T905	ADA Lever Handle Faucet	☐	147.50
87T910	Push Button Faucet with Mixing Tee		169.20
87T911	ADA Lever Handle Faucet with Mixing Tee	☐	179.45

FAUCET COVER PLATE (for above 87T faucets)			
MODEL	DESCRIPTION		PRICE
87T151	With Center Faucet Hole for 4" Centers (cast brass)	*	41.70

METERING FAUCETS (with 0.5 gpm (1.9 L/min.) Vandal Resistant Non-Aerating Spray Outlet)			
MODEL	DESCRIPTION		PRICE
86T1053	4" Cast Centerset, ADA Lever Handles, Open Grid Strainer	☐ *	266.30
86T1153	4" Cast Centerset, ADA Lever Handle, Less Pop-up Hole	☐ *	250.60

METERING FAUCETS (with 0.35 gpm (1.32 L/min.) Vandal Resistant Non-Aerating Spray Outlet)			
MODEL	DESCRIPTION		PRICE
86T1093	4" Cast Centerset, ADA Lever Handles, Open Grid Strainer	☐	266.30
86T1193	4" Cast Centerset, ADA Lever Handle, Less Pop-up Hole	☐	250.60

METERING FAUCETS (with 0.5 gpm (1.9 L/min.) Vandal Resistant Non-Aerating Spray Outlet)			
MODEL	DESCRIPTION		PRICE
86T0104	Push Button Faucet (86T1104) with Cover Plate (86T151)	*	159.20
86T1104	Push Button Faucet	*	139.25

METERING FAUCETS (with 0.35 gpm (1.32 L/min.) Vandal Resistant Non-Aerating Spray Outlet)			
MODEL	DESCRIPTION		PRICE
86T0194	Push Button Faucet (86T1194) with Cover Plate (86T151)		159.20
86T1194	Push Button Faucet		139.25

FAUCET COVER PLATE (for above 86T Single hole models)			
MODEL	DESCRIPTION		PRICE
86T151	4" Cover Plate for use with 86T1104 & 86T1194		41.70

* – Stock Item

Flow rates are at 60 PSI (414 kPa)



Code compliant products applies to entire series.

DELTA COMMERCIAL TECHNICAL SERVICE 1-877-509-2680
 ONLINE CATALOGS: www.deltacommercialfaucets.com (Core products ONLY)
www.specselect.com (Complete Product Offering & Part Numbering System)



86T505

FLUSH VALVES FOR WASHDOWN URINAL (No Backflow Protection)

MODEL	DESCRIPTION	PRICE
86T502	Oscillating Lever Handle Valve, Back Inlet  *	129.35
86T503	Oscillating Lever Handle Valve, Top Inlet  *	129.35
86T505	Oscillating Lever Handle Valve, Back Inlet Stop  *	155.55

INSTALLATION WARNING: Models shown above must be installed on fixtures providing sufficient air gap protection against backflow.

VACUUM BREAKER FOR ABOVE VALVES

MODEL	DESCRIPTION	PRICE
86T610	3/4" Outlet Tube with Vacuum Breaker *	65.15

To order Urinal Valves with Vacuum Breaker, order Urinal Valve PLUS Vacuum Breaker (ie 86T505 & 86T610).
 Models supplied LESS Vacuum Breaker must be installed on fixture providing sufficient air gap protection against backflow.
 For DEFM-100 Electronic Sidemount Conversion Kit, see page C42.
 For DEMD-86 Series Electronic Washdown Urinal Valves, see page C47.

* – Stock Item

TECK® FLUSH VALVES, EXPOSED MODELS (Vacuum Breaker Standard)

MODEL	DESCRIPTION	PRICE
WATER CLOSETS		
Standard Flush 1.6 gallons (6 liter) Factory Set – Field Adjustable		
81T201	1½" top spud, 11½" height, 1" inlet	190.55
81T201-30	1½" top spud, 11½" height (LESS stop, WITH modified tail to fit Sloan®/Zurn® stop)	174.10
81T221	1½" top spud, 24" height, 1" inlet	208.20
81T261	1½" top spud (offset), 24" height, 1" inlet	300.45
81T271	1½" back spud, 15" height, 1" inlet	215.70

WATER CLOSET ADDITIONAL OPTIONS & NOTES

SUFFIX NO.	DESCRIPTION	ADD-ON TO PRICE
WATER CLOSETS		
-1	Trap Seal Primer and for detergent/disinfectant Tee (Add -1 to Flush Valve Model Number) Available on water closet valves only	46.55
-5	Center Bumper on Valve (Add -5 to Flush Valve Model Number) for seat with cover (81T201 & 81T271 ONLY)	14.60
-6	1.6 gallons (6 liter) Factory Set Flush, Not Field Adjustable (Add -6 to Flush Valve Model Number)	No Additional Charge
-48	1.27 gallons (4.8 liter) Factory Set Flush, Not Field Adjustable (Add -48 to Flush Valve Model Number)	No Additional Charge

Select one only

TECK® FLUSH VALVES, EXPOSED MODELS (Vacuum Breaker Standard)

MODEL	DESCRIPTION	PRICE
URINALS		
Standard Flush 0.5 gallons (1.9 liter) Factory Set – Field Adjustable		
81T231	¾" top spud, 13" height, ¾" copper sweat inlet	190.55
81T231-30	¾" top spud, 13" height (LESS stop, WITH modified tail to fit Sloan®/Zurn® stop)	174.10

URINALS ADDITIONAL OPTIONS & NOTES

SUFFIX NO.	DESCRIPTION	PRICE
-05	0.125 gallons (0.5 liter) Factory Set Flush, Not Field Adjustable (Add -05 to Flush Valve Model Number)	No Additional Charge
-19	0.5 gallons (1.9 liter) Factory Set Flush, Not Field Adjustable (Add -19 to Flush Valve Model Number)	No Additional Charge

Select one only

FLUSH VALVE ACCESSORIES

MODEL	DESCRIPTION	PRICE
9T400	14" x 14" S/S Cover and Access Panel	150.40
9T500	14" x 20" S/S Cover and Access Panel	189.45
060115A	¾" Dia. C.P. Brass Adjustable Split Ring Hanger	58.45
060117A	1½" Dia. C.P. Brass Adjustable Split Ring Hanger	70.75

For DEFM-100 Electronic Sidemount Conversion Kit, see page C42.

Sloan® is a registered trademark of Sloan Valve Company. Zurn® is a registered trademark of Zurn Industries, LLC.

* – Stock Item



Flush Valves

REMOTE CONTROL CONCEALED MODELS (Vacuum Breaker Standard)

MODEL	DESCRIPTION	PRICE
WATER CLOSETS		
Standard Flush 1.6 gallons (6 liter) Factory Set – Field Adjustable		
83T000	1½" F.I.P. penal back spud, 1" inlet with ⅝" vandal resistant push button	307.20 *
83T140	1½" wall hung back spud, 1" inlet with ⅝" vandal resistant push button	289.00
83T141	1½" wall hung back spud, 1" inlet with oscillating handle	305.10 *
83T240	1½" free standing back spud, 1" inlet with ⅝" vandal resistant push button	318.45
83T241	1½" free standing back spud, 1" inlet with oscillating handle	328.45
83T340	1½" top spud, 1" inlet with ⅝" vandal resistant push button	335.20
83T341	1½" top spud, 1" inlet with oscillating handle	354.40
URINALS		
Standard Flush 0.5 gallons (1.9 liter) Factory Set – Field Adjustable		
83T430	¾" back spud, ¾" inlet with ⅝" vandal resistant push button	324.80 *
83T431	¾" back spud, ¾" inlet with oscillating handle	318.45

WATER CLOSET ADDITIONAL OPTIONS & NOTES

SUFFIX NO.	DESCRIPTION	ADD-ON TO PRICE
WATER CLOSETS		
-6	1.6 gallons (6 liter) Factory Set Flush, Not Field Adjustable (Add -6 to Flush Valve Model Number)	No Additional Charge
-48	1.27 gallons (4.8 liter) Factory Set Flush, Not Field Adjustable (Add -48 to Flush Valve Model Number)	No Additional Charge
Select one only		

URINAL ADDITIONAL OPTIONS & NOTES

SUFFIX NO.	DESCRIPTION	ADD-ON TO PRICE
URINALS		
-05	0.125 gallons (0.5 liter) Factory Set Flush, Not Field Adjustable (Add -05 to Flush Valve Model Number)	No Additional Charge
-19	0.5 gallons (1.9 liter) Factory Set Flush, Not Field Adjustable (Add -19 to Flush Valve Model Number)	No Additional Charge
Select one only		

* – Stock Item



ELECTRONIC BATTERY FLUSH VALVES EXPOSED MODELS		
MODEL	DESCRIPTION	PRICE
SINGLE FLUSH WATER CLOSETS		
Standard Flush 1.6 gallons (6 liter) Factory Set – Field Adjustable		
81T201BTA	Battery Operated Electronic, 1½" top spud, 11½" height, 1" inlet	546.15
81T201BTA-20	Battery Operated Electronic Retrofit Kit , 1½" top spud, 11½" height, LESS stop	520.15
81T201BTA-30	Battery Operated Electronic Retrofit Kit , 1½" top spud, 11½" height, LESS stop, WITH modified tail to fit Sloan®/Zurn® stop	520.15
81T221BTA	Battery Operated Electronic, 1½" top spud, 24" height, 1" inlet	560.05
URINALS		
Standard Flush 0.5 gallons (1.9 liter) Factory Set – Field Adjustable		
81T231BTA	Battery Operated Electronic, ¾" top spud, 13" height, ¾" copper sweat inlet	546.15
81T231BTA-20	Battery Operated Electronic Retrofit Kit , ¾" top spud, 13" height, LESS stop	520.15
81T231BTA-30	Battery Operated Electronic Retrofit Kit , ¾" top spud, 13" height, LESS stop, WITH modified tail to fit Sloan®/Zurn® stop	520.15

Flush Valves

See pages C132-C133 for Electronic Concealed Models.
Batteries included on all battery version models.

FLUSH VALVE VARIATIONS		
SUFFIX NO.	DESCRIPTION	ADD-ON TO PRICE
SINGLE FLUSH WATER CLOSET ADDITIONAL OPTIONS & NOTES		
-1	Trap Seal Primer and for detergent/disinfectant Tee (Add -1 to Flush Valve Model Number) Available on water closet valves only	46.55
-6	1.6 gallons (6 liter) Factory Set Flush, Not Field Adjustable (Add -6 to Flush Valve Model Number)	No Additional Charge
-13	3.4 gallons (13 liter) Factory Set Flush, Field Adjustable (Add -13 to Flush Valve Model Number) - only available on 81T201BTA-20 and -30	No Additional Charge
-48	1.27 gallons (4.8 liter) Factory Set Flush, Not Field Adjustable (Add -48 to Flush Valve Model Number)	No Additional Charge
-DF	Dual Flush mode factory set to ON provides full flush or 30% reduced flush based on time and distance from valve. Available only on flush valves with a 1.6 gallons (6 liter) Field Adjustable factory set flush. (Add -DF to Flush Valve Model Number.)	No Additional Charge
URINAL ADDITIONAL OPTIONS & NOTES		
-05	0.125 gallons (0.5 liter) Factory Set Flush, Not Field Adjustable (Add -05 to Flush Valve Model Number)	No Additional Charge
-19	0.5 gallons (1.9 liter) Factory Set Flush, Not Field Adjustable (Add -19 to Flush Valve Model Number)	No Additional Charge

Sloan® is a registered trademark of Sloan Valve Company. Zurn® is a registered trademark of Zurn Industries, LLC.

* – Stock Item



Flush Valves

ELECTRONIC BATTERY FLUSH VALVES EXPOSED MODELS WITH MANUAL MECHANICAL OVERRIDE BUTTON

MODEL	DESCRIPTION	PRICE
SINGLE FLUSH WATER CLOSETS		
81T201BTA-MMO	Battery Operated Electronic, 1½" top spud, 11½" height, 1" inlet, 1.6 gallons (6 liter) Factory Set, Field Adjustable	546.15
81T201BTA-48-MMO	Battery Operated Electronic, 1½" top spud, 11½" height, 1" inlet, 1.27 gallons (4.8 liter) Factory Set Flush, Not Field Adjustable	546.15
URINALS		
81T231BTA-MMO	Battery Operated Electronic, ¾" top spud, 13" height, ¾" copper sweat inlet 0.5 gallons (1.9 liter) Factory Set, Field Adjustable	546.15
81T231BTA-05-MMO	Battery Operated Electronic, ¾" top spud, 13" height, ¾" copper sweat inlet 0.125 gallons (0.5 liter) Factory Set Flush, Not Field Adjustable	546.15

See pages C132-C133 for Electronic Concealed Models.
Batteries included on all battery version models.

* – Stock Item



ELECTRONIC HARDWIRE FLUSH VALVES EXPOSED MODELS		
MODEL	DESCRIPTION	PRICE
SINGLE FLUSH WATER CLOSETS Standard Flush 1.6 gallons (6 liter) Factory Set – Field Adjustable		
81T201HWA	Hardwire Electronic, 1½” top spud, 11½” height, 1” inlet	593.60
81T201HWA-20	Hardwire Electronic Retrofit Kit , 1½” top spud, 11½” height, LESS stop	567.55
81T201HWA-30	Hardwire Electronic Retrofit Kit , 1½” top spud, 11½” height, LESS stop, WITH modified tail to fit Sloan®/Zurn® stop	567.55
81T221HWA	Hardwire Electronic, 1½” top spud, 24” height, 1” inlet	607.55
URINALS Standard Flush 0.5 gallons (1.9 liter) Factory Set – Field Adjustable		
81T231HWA	Hardwire Electronic, ¾” top spud, 13” height, ¾” copper sweat inlet	593.60
81T231HWA-20	Hardwire Electronic Retrofit Kit , ¾” top spud, 13” height, LESS stop	567.55
81T231HWA-30	Hardwire Electronic Retrofit Kit , ¾” top spud, 13” height, LESS stop, WITH modified tail to fit Sloan®/Zurn® stop	567.55

Flush Valves

See pages C132-C133 for Electronic Concealed Models.
Transformer to be ordered separately for Hardwire Models. See page C133.

FLUSH VALVE VARIATIONS		
SUFFIX NO.	DESCRIPTION	ADD-ON TO PRICE
SINGLE FLUSH WATER CLOSET ADDITIONAL OPTIONS & NOTES		
-1	Trap Seal Primer and for detergent/disinfectant Tee (Add -1 to Flush Valve Model Number) Available on water closet valves only	46.55
-6	1.6 gallons (6 liter) Factory Set Flush, Not Field Adjustable (Add -6 to Flush Valve Model Number)	No Additional Charge
-13	3.4 gallons (13 liter) Factory Set Flush, Field Adjustable (Add -13 to Flush Valve Model Number) - only available on 81T201-20 and -30	No Additional Charge
-48	1.27 gallons (4.8 liter) Factory Set Flush, Not Field Adjustable (Add -48 to Flush Valve Model Number)	No Additional Charge
-BB	Hardwire converter with Battery Back-Up, to keep electronic units running during power failures until power has been fully restored (Add -BB to Flush Valve Model Number)	44.35
-DF	Dual Flush mode factory set to ON provides full flush or 30% reduced flush based on time and distance from valve. Available only on flush valves with a 1.6 gallons (6 liter) Field Adjustable factory set flush. (Add -DF to Flush Valve Model Number.)	No Additional Charge
URINAL ADDITIONAL OPTIONS & NOTES		
-05	0.125 gallons (0.5 liter) Factory Set Flush, Not Field Adjustable (Add -05 to Flush Valve Model Number)	No Additional Charge
-19	0.5 gallons (1.9 liter) Factory Set Flush, Not Field Adjustable (Add -19 to Flush Valve Model Number)	No Additional Charge
-BB	Hardwire converter with Battery Back-Up, to keep electronic units running during power failures until power has been fully restored (Add -BB to Flush Valve Model Number)	44.35

Sloan® is a registered trademark of Sloan Valve Company. Zurn® is a registered trademark of Zurn Industries, LLC.

* – Stock Item



Flush Valves

ELECTRONIC HARDWARE FLUSH VALVES EXPOSED MODELS

MODEL	DESCRIPTION	PRICE
WATER CLOSETS		
Standard Flush 1.6 gallons (6 liter) Factory Set – Field Adjustable		
81T201-WMSHWA	Hardwire Electronic, 1½" top spud, 11½" height, 1" inlet, with 4" wall mount sensor	739.00
URINALS		
Standard Flush 0.5 gallons (1.9 liter) Factory Set – Field Adjustable		
81T231-WMSHWA	Hardwire Electronic, ¾" top spud, 13" height, ¾" copper sweat inlet, with 4" wall mount sensor	739.00

See pages C132-C133 for additional Electronic Concealed Models.
Transformer to be ordered separately for Hardwire Models. See page C133.
If Battery Operated Models required -Order Hardwire Model AND 061299A Battery Conversion Kit (Separate Order).

FLUSH VALVE VARIATIONS

SUFFIX NO.	DESCRIPTION	ADD-ON TO PRICE
WATER CLOSET ADDITIONAL OPTIONS & NOTES		
-1	Trap Seal Primer and for detergent/disinfectant Tee (Add -1 to Flush Valve Model Number) Available on water closet valves only	46.55
-6	1.6 gallons (6 liter) Factory Set Flush, Not Field Adjustable (Add -6 to Flush Valve Model Number)	No Additional Charge
-48	1.27 gallons (4.8 liter) Factory Set Flush, Not Field Adjustable (Add -48 to Flush Valve Model Number)	No Additional Charge
-BB	Hardwire converter with Battery Back-Up, to keep electronic units running during power failures until power has been fully restored (Add -BB to Flush Valve Model Number. Not available on Battery Operated Units.)	44.35
URINAL ADDITIONAL OPTIONS & NOTES		
-05	0.125 gallons (0.5 liter) Factory Set Flush, Not Field Adjustable (Add -05 to Flush Valve Model Number)	No Additional Charge
-19	0.5 gallons (1.9 liter) Factory Set Flush, Not Field Adjustable (Add -19 to Flush Valve Model Number)	No Additional Charge
-BB	Hardwire converter with Battery Back-Up, to keep electronic units running during power failures until power has been fully restored (Add -BB to Flush Valve Model Number. Not available on Battery Operated Units.)	44.35

* – Stock Item

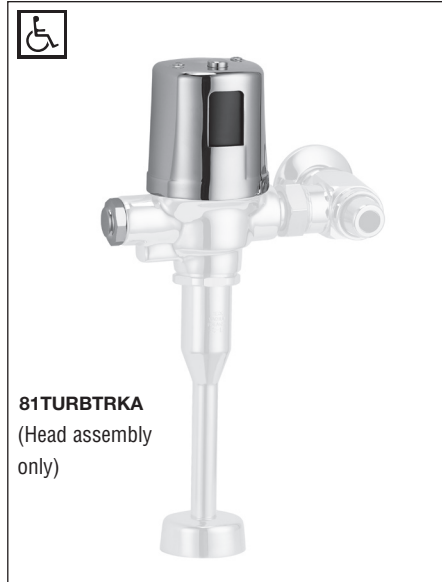

EXPOSED BATTERY OPERATED RETROFIT KIT FOR WATER CLOSET

MODEL	(Standard Flush 1.6 gallon (6 Liter) Factory Set - Field Adjustable) DESCRIPTION	PRICE
81TWCBTRKA	Battery Operated Electronic Water Closet Retrofit Kit LESS Body, Stop, Outlet Tubing *	392.20

EXPOSED BATTERY OPERATED RETROFIT KIT FOR URINAL

MODEL	(Standard Flush 0.5 gallon (1.9 Liter) Factory Set - Field Adjustable) DESCRIPTION	PRICE
81TURBTRKA	Battery Operated Electronic Urinal Retrofit Kit LESS Body, Stop, Outlet Tubing *	392.20

FLUSH VALVE VARIATIONS

SUFFIX NO.	DESCRIPTION	ADD-ON TO PRICE
SINGLE FLUSH WATER CLOSET ADDITIONAL OPTIONS & NOTES		
-6	1.6 gallons (6 liter) Factory Set Flush, Not Field Adjustable (Add -6 to Flush Valve Model Number)	No Additional Charge
-13	3.4 gallons (13 liter) Factory Set Flush, Field Adjustable (Add -13 to Flush Valve Model Number)	No Additional Charge
-48	1.27 gallons (4.8 liter) Factory Set Flush, Not Field Adjustable (Add -48 to Flush Valve Model Number)	No Additional Charge
-DF	Dual Flush mode factory set to ON provides full flush or 30% reduced flush based on time and distance from valve. Available only on flush valves with a 1.6 gallons (6 liter) Field Adjustable factory set flush. (Add -DF to Flush Valve Model Number.)	No Additional Charge
URINAL ADDITIONAL OPTIONS & NOTES		
-05	0.125 gallons (0.5 liter) Factory Set Flush, Not Field Adjustable (Add -05 to Flush Valve Model Number)	No Additional Charge
-19	0.5 gallons (1.9 liter) Factory Set Flush, Not Field Adjustable (Add -19 to Flush Valve Model Number)	No Additional Charge

HARDWIRE KIT

MODEL	DESCRIPTION	PRICE
061069A	Hardwire Kit for 3RD Gen E-FV (includes 24 VAC to 6 VDC converter, V.R. copper tube conduit and 2 x4" Junction Box) Transformer Ordered Separately	76.20

Transformer to be ordered separately for Hardwire Models, see Page C133.

* – Stock Item

Rough-in and Trim Ordered and Priced Separately.

Flush Valves

HARDWARE				
WATER CLOSETS		Standard Flush 1.6 gallons (6 liter) Factory Set – Field Adjustable		
MODEL		Fixture Type & SS Cover Size	PRICE	
Rough-in	Trim		Rough-in	Trim
1600T6102ARI	1600T6102ATR	Wall Hung, 1½" Back Inlet, 14 x 20" Cover, with 12 x 18" Frame	488.75	488.75
1600T6103ARI	1600T6103ATR	Wall Hung, 1½" Back Inlet, 14" Cover, with 12" Frame *	482.80	482.80
1600T6104ARI	1600T6104ATR	Wall Hung, 1½" Back Inlet, 4" Cover, with Box	369.60	369.60
1600T6202ARI	1600T6202ATR	Freestanding, 1½" Back Inlet, 14 x 20" Cover, with 12 x 18" Frame	518.50	518.50
1600T6203ARI	1600T6203ATR	Freestanding, 1½" Back Inlet, 14" Cover, with 12" Frame	512.60	512.60
1600T6204ARI	1600T6204ATR	Freestanding, 1½" Back Inlet, 4" Cover, with Box	399.35	399.35
1600T6302ARI	1600T6302ATR	Toilet, 1½" Top Inlet, 14 x 20" Cover, with 12 x 18" Frame	548.30	548.30
1600T6303ARI	1600T6303ATR	Toilet, 1½" Top Inlet, 14" Cover, with 12" Frame	542.35	542.35
1600T6304ARI	1600T6304ATR	Toilet, 1½" Top Inlet, 4" Cover, with Box	429.15	429.15
URINALS		Standard Flush 0.5 gallons (1.9 liter) Factory Set – Field Adjustable		
MODEL		Fixture Type & SS Cover Size	PRICE	
Rough-in	Trim		Rough-in	Trim
1600T6402ARI	1600T6402ATR	Syphon Jet Urinal, ¾" Back Inlet, 14 x 20" Cover, with 12 x 18" Frame (1)	476.80	476.80
1600T6403ARI	1600T6403ATR	Syphon Jet Urinal, ¾" Back Inlet, 14" Cover, with 12" Frame (1) *	470.85	470.85
1600T6404ARI	1600T6404ATR	Syphon Jet Urinal, ¾" Back Inlet, 4" Cover, with Box (1)	357.65	357.65

Transformer ordered separately. See page C133.

If Battery Operated Models required -Order Hardwire Model AND 061299A Battery Conversion Kit (Separate Order).

(1) When used for Top Inlet Urinal Fixture - Exposed Tubing, Flanges, Elbow, etc. SUPPLIED BY OTHERS

FLUSH VALVE VARIATIONS		
SUFFIX NO.	DESCRIPTION	ADD-ON TO PRICE
WATER CLOSET ADDITIONAL OPTIONS & NOTES		
-6	1.6 gallons (6 liter) Factory Set Flush, Not Field Adjustable (Add -6 to RI Flush Valve Model Number) <input type="checkbox"/> Select one only	No Additional Charge
-48	1.27 gallons (4.8 liter) Factory Set Flush, Not Field Adjustable (Add -48 to RI Flush Valve Model Number) <input type="checkbox"/> Select one only	No Additional Charge
-BB	Battery Back-Up - available on Hardwire operated TR models ONLY.	44.35
URINAL ADDITIONAL OPTIONS & NOTES		
-05	0.125 gallons (0.5 liter) Factory Set Flush, Not Field Adjustable (Add -05 to RI Flush Valve Model Number) <input type="checkbox"/> Select one only	No Additional Charge
-19	0.5 gallons (1.9 liter) Factory Set Flush, Not Field Adjustable (Add -19 to RI Flush Valve Model Number) <input type="checkbox"/> Select one only	No Additional Charge
-BB	Battery Back-Up - available on Hardwire operated TR models ONLY.	44.35

* – Stock Item

Rough-in and Trim Ordered and Priced Separately where noted.

HARDWIRE					
MODEL		(Factory Set 0.5 gallon (1.9 Liter) Flush) Fixture Type & SS Cover Size		PRICE	
Rough-in	Trim			Rough-in	Trim
1600T9001RI	1600T9001TR	¾" Back Inlet, 10" Cover with S/S Outlet Hose	*	381.45	381.45
1600T9003RI	1600T9003TR	¾" Top Inlet, 10" Cover (1)		369.60	369.60
Available as COMPLETE model only				TOTAL PRICE	
1600T9006		Back or Top Inlet, 4" Cover (1)		572.15	

Transformer ordered separately for Hardwire models. See below.

If Battery Operated Models required -Order Hardwire Model AND 061299A Battery Conversion Kit (Separate Order).

(1) When used for Top Inlet Urinal Fixture - Exposed Tubing, Flanges, Elbow, etc. SUPPLIED BY OTHERS

Models must be installed on fixtures providing sufficient air gap protection against backflow.

ADD-ON OPTIONS (ADD THE SUFFIX TO THE END OF THE MODEL NUMBER TO CHOOSE THIS OPTION)		
-SUFFIX NUMBER	DESCRIPTION	ADD-ON TO PRICE
-BB	Battery Back-Up - available on Hardwire operated TR or COMPLETE models ONLY.	44.35

OPTIONAL ACCESSORIES (Use Component Parts Discount)		
MODEL	DESCRIPTION	PRICE
060704A	20VA Transformer (For up to 10 – 590 or 860T Series, or up to 5 – 3000T, 1500T, 590T, 590TP, 591T, 591TP, 1600T, 81THW, DEMD, 600T, 620TP & 630TP Series)	57.00
060771A	40VA Transformer (For up to 10 – 3000T, 1500T, 590T, 590TP, 591T, 591TP, 1600T, 81THW, DEMD, 600T, 620TP & 630TP Series)	58.00
060772A	100VA Transformer (For up to 25 – 3000T, 1500T, 590T, 590TP, 591T, 591TP, 1600T, 81THW, DEMD, 600T, 620TP & 630TP Series)	153.05
RP32856	Plug-In Transformer (For up to 10 – 590 or 860T Series, or up to 5 – 3000T, 1500T, 590T, 590TP, 591T, 591TP, 1600T, 81THW, DEMD, 600T, 620TP & 630TP Series)	42.80

* – Stock Item



Model	Price
* - Stock Item	
* 590T0120	541.10
590T0130	531.80
590T0160	541.10

Note : Available as complete models ONLY

ADD-ON OPTIONS (ADD THE SUFFIX TO THE END OF THE MODEL NUMBER TO CHOOSE THIS OPTION)		
-SUFFIX NUMBER	DESCRIPTION	ADD-ON TO PRICE
-BB	Battery Back-Up - available on Hardwire operated models ONLY	44.35

Code compliant applies to entire series.

590T0120 (shown)

590T0 **Hardwire Operated 48.45 (Base Product Price)**
 590T1 **Battery Operated 48.45 (Base Product Price)**

To complete a Product Price for the above, add the prices of the chosen variations (listed below) to the **Base Product Price**.
 A number from each option column must be used.

SPOUT AND SENSOR		OUTLET		CONTROL BOX	
	0		0	Base Model with Surface Mount Housing - No Mixing Valve 204.25	0
Single Hole Deck Mount Hi-Rise Spout with Integral Sensor	1		1	For Recessed Control Box #1, see page C135	1
Deck Mount Hi-Rise Spout with Integral Sensor and 4" Cover Plate	2	Vandal Resistant 1.5 gpm (5.7 L/min.) Laminar w/Agion® Antimicrobial	2		2
	3	Vandal Resistant 1.5 gpm (5.7 L/min.) Flow Control Aerator	3		3
	4		4		4
	5	Vandal Resistant 0.5 gpm (1.9 L/min.) Laminar Outlet	5		5
	6	Vandal Resistant 1.0 gpm (3.8 L/min.) Laminar Outlet	6		6
	7		7		7
Deck Mount Hi-Rise Spout with Integral Sensor and 8" Cover Plate	8		8	For Recessed Control Box #8, see page C135	8
	9	Vandal Resistant 0.35 gpm (1.32 L/min.) Non-Aerating Spray Outlet	9		9

Transformer to be ordered separately for Hardwire models, see page C133.
 Batteries included on all battery version models.

Flow rates are at 60 PSI (414 kPa)

DELTA COMMERCIAL TECHNICAL SERVICE 1-877-509-2680
 ONLINE CATALOGS: www.deltacommercialfaucets.com (Core products ONLY)
www.specselect.com (Complete Product Offering & Part Numbering System)



Model	Price
* - Stock Item	
590T0121TR	285.40
* 590T0128TR	277.10

Note : Must order Rough-In Number AND Trim Number SEPARATELY

ADD-ON OPTIONS (ADD THE SUFFIX TO THE END OF THE TRIM MODEL NUMBER TO CHOOSE THIS OPTION)		
-SUFFIX NUMBER	DESCRIPTION	ADD-ON TO PRICE
-BB	Battery Back-Up - available on Hardwire operated models ONLY.	44.35

Code compliant applies to entire series.

590T0121TR (shown)

ELAVT0001ARI *	Rough-In ONLY with NO Mixing Valve	417.75
ELAVT0008ARI *	Rough-In ONLY with Thermostatic Mixing Valve	633.25
590T0 <input type="checkbox"/> <input type="checkbox"/> <input type="checkbox"/> TR	Trim ONLY - Hardwire Operated	48.45 (Base Product Price)
590T1 <input type="checkbox"/> <input type="checkbox"/> <input type="checkbox"/> TR	Trim ONLY - Battery Operated	48.45 (Base Product Price)

To complete a Trim Product Price for the above, add the prices of the chosen variations (listed below) to the **Base Product Price**.
 A number from each option column must be used.

SPOUT AND SENSOR		OUTLET		CONTROL BOX	
	0		0	For Surface Mount Control Box #0, see page C134	
Single Hole Deck Mount Hi-Rise Spout with Integral Sensor	1		1	Recessed Mount with 10" x 10" Box - No Mixing Valve (1) Requires separate purchase of ELAVT0001ARI	
Deck Mount Hi-Rise Spout with Integral Sensor and 4" Cover Plate	2	Vandal Resistant 1.5 gpm (5.7 L/min.) Laminar w/Agion® Antimicrobial	24.10	2	52.25
	3	Vandal Resistant 1.5 gpm (5.7 L/min.) Flow Control Aerator	14.80	3	
	4			4	
	5	Vandal Resistant 0.5 gpm (1.9 L/min.) Laminar Outlet	24.10	5	
	6	Vandal Resistant 1.0 gpm (3.8 L/min.) Laminar Outlet	24.10	6	
	7			7	
Deck Mount Hi-Rise Spout with Integral Sensor and 8" Cover Plate	8			8	Recessed Mount with 10" x 10" Box with Thermostatic Mixing Valve (1) Requires separate purchase of ELAVT0008ARI
	9	Vandal Resistant 0.35 gpm (1.32 L/min.) Non-Aerating Spray Outlet	24.10	9	43.95

(1) Connection from box to spout not supplied. Batteries included on all battery version models. Transformer to be ordered separately for Hardwire models, see page C133.

Flow rates are at 60 PSI (414 kPa)



590TP0150 (shown)

Model	Price
* - Stock Item	
* 590TP0150	582.50
590TP0250	649.55
590TP1150	582.50

Note : Available as complete models ONLY

Code compliant applies to entire series.

ADD-ON OPTIONS (ADD THE SUFFIX TO THE END OF THE MODEL NUMBER TO CHOOSE THIS OPTION)		
-SUFFIX NUMBER	DESCRIPTION	ADD-ON TO PRICE
-BB	Battery Back-Up - available on Hardwire operated models ONLY	44.35

590TP0 **Hardwire Operated 48.45 (Base Product Price)**

590TP1 **Battery Operated 48.45 (Base Product Price)**

To complete a Product Price add the prices of chosen variations (listed below) to the **Base Product Price**.

A number from each option column must be used.

SPOUT AND SENSOR		OUTLET		CONTROL BOX	
	0			Base Model with Surface Mount Housing - No Mixing Valve	0
				204.25	
Single Hole Deck Mount Hi-Rise Spout	305.70	1		For Recessed Control Box #1, see page C137	1
Deck Mount Hi-Rise Spout 4" Cover Plate	372.75	2	Vandal Resistant 1.5 gpm (5.7 L/min.) Laminar w/Agion® Antimicrobial	24.10	2
		3	Vandal Resistant 1.5 gpm (5.7 L/min.) Flow Control Aerator	14.80	3
		4			4
		5	Vandal Resistant 0.5 gpm (1.9 L/min.) Laminar Outlet	24.10	5
		6	Vandal Resistant 1.0 gpm (3.8 L/min.) Laminar Outlet	24.10	6
		7			7
Deck Mount Hi-Rise Spout 8" Cover Plate	391.85	8		For Recessed Control Box #8, see page C137	8
		9	Vandal Resistant 0.35 gpm (1.32 L/min.) Non-Aerating Spray Outlet	24.10	9

Transformer to be ordered separately for Hardwire models, see page C133.

Batteries included on all battery version models.

Use 061271A to convert from original Proximity models to latest technology, including metering mode and periodic rinse features.

Flow rates are at 60 PSI (414 kPa)

DELTA COMMERCIAL TECHNICAL SERVICE 1-877-509-2680
ONLINE CATALOGS: www.deltacommercialfaucets.com (Core products ONLY)
www.specselect.com (Complete Product Offering & Part Numbering System)



590TP0158TR (shown)

Model Price

* - Stock Item

* 590TP0128TR	318.50
* 590TP0158TR	318.50

Note : Must order Rough-In Number AND Trim Number SEPARATELY

Code compliant applies to entire series.

ADD-ON OPTIONS (ADD THE SUFFIX TO THE END OF THE MODEL NUMBER TO CHOOSE THIS OPTION)		
-SUFFIX NUMBER	DESCRIPTION	ADD-ON TO PRICE
-BB	Battery Back-Up - available on Hardwire operated models ONLY	44.35

ELAVT0001ARI *	Rough-In ONLY with NO Mixing Valve	417.75
ELAVT0008ARI *	Rough-In ONLY with Thermostatic Mixing Valve	633.25
590TP0 <input type="checkbox"/> <input type="checkbox"/> <input type="checkbox"/> TR	Trim ONLY - Hardwire Operated	48.45 (Base Product Price)
590TP1 <input type="checkbox"/> <input type="checkbox"/> <input type="checkbox"/> TR	Trim ONLY - Battery Operated	48.45 (Base Product Price)

To complete a Trim Product Price add the prices of chosen variations (listed below) to the **Base Product Price**.
A number from each option column must be used.

SPOUT AND SENSOR		OUTLET		CONTROL BOX	
	0		0	For Surface Mount Control Box #0, see page C136	0
Single Hole Deck Mount Hi-Rise Spout	1		1	Recessed Mount with 10" x 10" Box - No Mixing Valve (1) Requires separate purchase of ELAVT0001ARI	1
202.00				52.25	
Deck Mount Hi-Rise Spout 4" Cover Plate	2	Vandal Resistant 1.5 gpm (5.7 L/min.) Laminar w/Agion® Antimicrobial	24.10		2
269.05					
	3	Vandal Resistant 1.5 gpm (5.7 L/min.) Flow Control Aerator	14.80		3
	4				4
	5	Vandal Resistant 0.5 gpm (1.9 L/min.) Laminar Outlet	24.10		5
	6	Vandal Resistant 1.0 gpm (3.8 L/min.) Laminar Outlet	24.10		6
	7				7
Deck Mount Hi-Rise Spout 8" Cover Plate	8			Recessed Mount with 10" x 10" Box with Thermostatic Mixing Valve (1) Requires separate purchase of ELAVT0008ARI	8
288.15				43.95	
	9	Vandal Resistant 0.35 gpm (1.32 L/min.) Non-Aerating Spray Outlet	24.10		9

Electronics

(1) Connection from box to spout not supplied
Transformer to be ordered separately for Hardwire models, see page C133.
Batteries included on all battery version models.
Flow rates are at 60 PSI (414 kPa)
Use 061271A to convert from original Proximity models to latest technology, including metering mode and periodic rinse features.



Model	Price
* - Stock Item	
* 591T0250	541.10
* 591T1250	541.10

Note : Available as complete models ONLY

ADD-ON OPTIONS (ADD THE SUFFIX TO THE END OF THE MODEL NUMBER TO CHOOSE THIS OPTION)		
-SUFFIX NUMBER	DESCRIPTION	ADD-ON TO PRICE
-BB	Battery Back-Up - available on Hardwire operated models ONLY	44.35

Code compliant applies to entire series.

591T1250 (shown)

591T0 **Hardwire Operated** **48.45 (Base Product Price)**
591T1 **Battery Operated** **48.45 (Base Product Price)**

To complete a Product Price for the above, add the prices of the chosen variations (listed below) to the **Base Product Price**.
 A number from each option column must be used.

SPOUT AND SENSOR		OUTLET		CONTROL BOX	
	0			0	Base Model Surface Mount - No Mixing Valve 204.25
	1			1	For Recessed Control Box #1, see page C139
Cast Spout - 102 mm (4") 264.30	2	Vandal Resistant 1.5 gpm (5.7 L/min.) Laminar w/Agion® Antimicrobial	 24.10	2	
	3	Vandal Resistant 1.5 gpm (5.7 L/min.) Flow Control Aerator	 14.80	3	
	4			4	
	5	Vandal Resistant 0.5 gpm (1.9 L/min.) Laminar Outlet	 24.10	5	
	6	Vandal Resistant 1.0 gpm (3.8 L/min.) Laminar Outlet	 24.10	6	
	7			7	
	8			8	For Recessed Control Box #8, see page C139
	9	Vandal Resistant 0.35 gpm (1.32 L/min.) Non-Aerating Spray Outlet	 24.10	9	

Transformer to be ordered separately for Hardwire models, see page C133.
 Batteries included on all battery version models.

Flow rates are at 60 PSI (414 kPa)

DELTA COMMERCIAL TECHNICAL SERVICE 1-877-509-2680
 ONLINE CATALOGS: www.deltacommercialfaucets.com (Core products ONLY)
www.specselect.com (Complete Product Offering & Part Numbering System)



Model **Price**
 * - Stock Item
 * 591T1258TR 268.40

Note : Must order Rough-In Number AND Trim Number SEPARATELY



Code compliant applies to entire series.

591T1258TR (shown)

ADD-ON OPTIONS (ADD THE SUFFIX TO THE END OF THE TRIM MODEL NUMBER TO CHOOSE THIS OPTION)		
-SUFFIX NUMBER	DESCRIPTION	ADD-ON TO PRICE
-BB	Battery Back-Up - available on Hardwire operated models ONLY.	44.35

ELAVT0001ARI *	Rough-In ONLY with NO Mixing Valve	417.75
ELAVT0008ARI *	Rough-In ONLY with Thermostatic Mixing Valve	633.25
591T0 <input type="checkbox"/> <input type="checkbox"/> <input type="checkbox"/> TR	Trim ONLY - Hardwire Operated	48.45 (Base Product Price)
591T1 <input type="checkbox"/> <input type="checkbox"/> <input type="checkbox"/> TR	Trim ONLY - Battery Operated	48.45 (Base Product Price)

To complete a Trim Product Price for the above, add the prices of the chosen variations (listed below) to the **Base Product Price**.
 A number from each option column must be used.

SPOUT AND SENSOR	OUTLET	CONTROL BOX
0		0 For Surface Mount Control Box #0, see page C138
1		1 Recessed Mount with 10" x 10" Box - No Mixing Valve (1) Requires separate purchase of ELAVT0001ARI 52.25
Cast Spout - 102 mm (4") 151.90	2 Vandal Resistant 1.5 gpm (5.7 L/min.) Laminar w/Agion® Antimicrobial 24.10	2
3	3 Vandal Resistant 1.5 gpm (5.7 L/min.) Flow Control Aerator 14.80	3
4		4
5	5 Vandal Resistant 0.5 gpm (1.9 L/min.) Laminar Outlet 24.10	5
6	6 Vandal Resistant 1.0 gpm (3.8 L/min.) Laminar Outlet 24.10	6
7		7
8		8 Recessed Mount with 10" x 10" Box with Thermostatic Mixing Valve (1) Requires separate purchase of ELAVT0008ARI 43.95
9	9 Vandal Resistant 0.35 gpm (1.32 L/min.) Non-Aerating Spray Outlet 24.10	9

(1) Connection from box to spout not supplied.
 Transformer to be ordered separately for Hardwire models, see page C133.
 Batteries included on all battery version models.

Flow rates are at 60 PSI (414 kPa)

DELTA COMMERCIAL TECHNICAL SERVICE 1-877-509-2680
 ONLINE CATALOGS: www.deltacommercialfaucets.com (Core products ONLY)
www.specselect.com (Complete Product Offering & Part Numbering System)



Model	Price
591TP0250	582.50
591TP1250	582.50

Note : Available as complete models ONLY

ADD-ON OPTIONS (ADD THE SUFFIX TO THE END OF THE MODEL NUMBER TO CHOOSE THIS OPTION)		
-SUFFIX NUMBER	DESCRIPTION	ADD-ON TO PRICE
-BB	Battery Back-Up - available on Hardwire operated models ONLY.	44.35

Code compliant applies to entire series.

591TP1250 (shown)

591TP0 **Hardwire Operated 48.45 (Base Product Price)**
591TP1 **Battery Operated 48.45 (Base Product Price)**

To complete a Product Price add the prices of chosen variations (listed below) to the **Base Product Price**.
 A number from each option column must be used.

SPOUT AND SENSOR		OUTLET		CONTROL BOX	
	0		0	Base Model Surface Mount - No Mixing Valve 204.25	0
	1		1	For Recessed Control Box #1, see page C141	1
Cast Spout - 102 mm (4") 305.70	2	Vandal Resistant 1.5 gpm (5.7 L/min.) Laminar w/Agion® Antimicrobial	24.10		2
	3	Vandal Resistant 1.5 gpm (5.7 L/min.) Flow Control Aerator	14.80		3
	4				4
	5	Vandal Resistant 0.5 gpm (1.9 L/min.) Laminar Outlet	24.10		5
	6	Vandal Resistant 1.0 gpm (3.8 L/min.) Laminar Outlet	24.10		6
	7				7
	8			For Recessed Control Box #8, see page C141	8
	9	Vandal Resistant 0.35 gpm (1.32 L/min.) Non-Aerating Spray Outlet	24.10		9

Transformer to be ordered separately for Hardwire models, see page C133.

Batteries included on all battery version models.

Use 061271A to convert from original Proximity models to latest technology, including metering mode and periodic rinse features.

Flow rates are at 60 PSI (414 kPa)

DELTA COMMERCIAL TECHNICAL SERVICE 1-877-509-2680
 ONLINE CATALOGS: www.deltacommercialfaucets.com (Core products ONLY)
www.specselect.com (Complete Product Offering & Part Numbering System)



Model	Price
* - Stock Item	
* 591TP0258TR	309.80
* 591TP0268TR	309.80

Note : Must order Rough-In Number AND Trim Number SEPARATELY

Code compliant applies to entire series.

591TP0258TR (shown)

ADD-ON OPTIONS (ADD THE SUFFIX TO THE END OF THE TRIM MODEL NUMBER TO CHOOSE THIS OPTION)		
-SUFFIX NUMBER	DESCRIPTION	ADD-ON TO PRICE
-BB	Battery Back-Up - available on Hardwire operated models ONLY.	44.35

ELAVT0001ARI *	Rough-In ONLY with NO Mixing Valve	417.75
ELAVT0008ARI *	Rough-In ONLY with Thermostatic Mixing Valve	633.25
591TP0 <input type="checkbox"/> <input type="checkbox"/> <input type="checkbox"/> TR	Trim ONLY - Hardwire Operated	48.45 (Base Product Price)
591TP1 <input type="checkbox"/> <input type="checkbox"/> <input type="checkbox"/> TR	Trim ONLY - Battery Operated	48.45 (Base Product Price)

To complete a Trim Product Price for the above, add the prices of the chosen variations (listed below) to the **Base Product Price**.
A number from each option column must be used.

SPOUT AND SENSOR		OUTLET		CONTROL BOX	
	0			0	For Surface Mount Control Box #0, see page C140
	1			1	Recessed Mount with 10" x 10" Box - No Mixing Valve (1) Requires separate purchase of ELAVT0001ARI 52.25
Cast Spout - 102 mm (4")		2	Vandal Resistant 1.5 gpm (5.7 L/min.) Laminar w/Agion® Antimicrobial		24.10
	3	3	Vandal Resistant 1.5 gpm (5.7 L/min.) Flow Control Aerator		14.80
	4	4			
	5	5	Vandal Resistant 0.5 gpm (1.9 L/min.) Laminar Outlet		24.10
	6	6	Vandal Resistant 1.0 gpm (3.8 L/min.) Laminar Outlet		24.10
	7	7			
	8	8			Recessed Mount with 10" x 10" Box with Thermostatic Mixing Valve (1) Requires separate purchase of ELAVT0008ARI 43.95
	9	9	Vandal Resistant 0.35 gpm (1.32 L/min.) Non-Aerating Spray Outlet		24.10

(1) Connection from box to spout not supplied. Flow rates are at 60 PSI (414 kPa)
Transformer to be ordered separately for Hardwire models, see page C133.
Batteries included on all battery version models.

Use 061271A to convert from original Proximity models to latest technology, including metering mode and periodic rinse features.

DELTA COMMERCIAL TECHNICAL SERVICE 1-877-509-2680
ONLINE CATALOGS: www.deltacommercialfaucets.com (Core products ONLY)
www.specselect.com (Complete Product Offering & Part Numbering System)

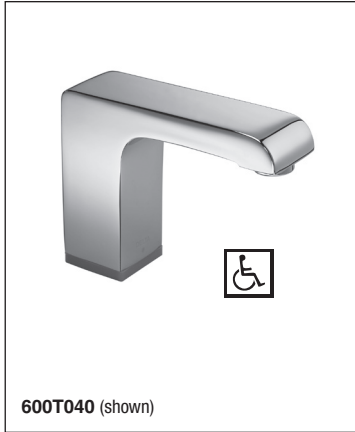

✓ Code compliant applies to entire series.

ELECTRONIC BATTERY FAUCETS			
MODEL		DESCRIPTION	PRICE
601T040		Battery Operated Electronic faucet with Proximity® Sensing Technology, Vandal Resistant 1.5 gpm (5.7 L/min) flow rate laminar outlet	583.30
601T050		Battery Operated Electronic faucet with Proximity® Sensing Technology, Vandal Resistant 0.5 gpm (1.9 L/min) flow rate laminar outlet	591.95
601T090		Battery Operated Electronic faucet with Proximity® Sensing Technology, Vandal Resistant 0.35 gpm (1.32 L/min) flow rate non-aerating spray outlet	591.95

ELECTRONIC HARDWIRE FAUCETS			
MODEL		DESCRIPTION	PRICE
600T040		Hardwire Electronic faucet with Proximity® Sensing Technology, Vandal Resistant 1.5 gpm (5.7 L/min) flow rate laminar outlet	583.30
600T050		Hardwire Electronic faucet with Proximity® Sensing Technology, Vandal Resistant 0.5 gpm (1.9 L/min) flow rate laminar outlet	591.95
600T090		Hardwire Electronic faucet with Proximity® Sensing Technology, Vandal Resistant 0.35 gpm (1.32 L/min) flow rate non-aerating spray outlet	591.95

ADD-ON OPTIONS (ADD THE SUFFIX TO THE END OF THE MODEL NUMBER TO CHOOSE THIS OPTION)		
-SUFFIX NUMBER	DESCRIPTION	ADD-ON TO PRICE
-BB	Battery Back-Up - available on Hardwire operated models ONLY	44.35
-SS	Brilliance® Stainless Finish. Available on single hole models and 062021A 4" cover plate ONLY	56.70

OPTIONAL COVER PLATES (ORDER SEPARATELY)		
MODEL	DESCRIPTION	PRICE
062021A	Decorative Cover Plate, 4" (102 mm)	20.05
061119A	Decorative Cover Plate, 8" (204 mm)	98.50

Supplied as Complete Model Only, with surface mount control box, no separate rough-in required. Flow rates are at 60 PSI (414 kPa)
 Transformer to be ordered separately for Hardwire Models, see page C133.
 Batteries included on all battery version models.
 Mixing valve to be ordered separately.
 Use 061271A to convert from original Proximity models to latest technology, including metering mode and periodic rinse features.

* – Stock Item

DELTA COMMERCIAL TECHNICAL SERVICE 1-877-509-2680
 ONLINE CATALOGS: www.deltacommercialfaucets.com (Core products ONLY)
www.specselect.com (Complete Product Offering & Part Numbering System)



Model

620TP3320

Price

582.50

Note : Available as complete models ONLY

Code compliant applies to entire series.

620TP3320 (shown)

ADD-ON OPTIONS (ADD THE SUFFIX TO THE END OF THE MODEL NUMBER TO CHOOSE THIS OPTION)		
-SUFFIX NUMBER	DESCRIPTION	ADD-ON TO PRICE
-BB	Battery Back-Up - available on Hardwire operated models ONLY	44.35
-SS	Brilliance® Stainless Finish	60.00

OPTIONAL COVER PLATES (ORDER SEPARATELY)		
PRODUCT NO.	DESCRIPTION	PRICE
061269A 061269SS	4" Cover Plate	64.30 77.15
061270A 061270SS	8" Cover Plate	112.50 133.90

620TP3 **3** **0** **Hardwire Operated 48.45 (Base Product Price)**

621TP3 **3** **0** **Battery Operated 48.45 (Base Product Price)**

To complete a Product Price add the prices of chosen variations (listed below) to the **Base Product Price**.

A number from each option column must be used.

SPOUT AND SENSOR		OUTLET		CONTROL BOX	
	0			0	Base Model with Surface Mount Housing - No Mixing Valve 204.25
	1	Vandal Resistant 2.2 gpm (8.3 L/min.) Laminar Outlet	24.10	1	For Recessed Control Box #1, see page C144
	2	Vandal Resistant 1.5 gpm (5.7 L/min.) Laminar Outlet	24.10	2	
Single Hole Deck Mount Gooseneck Spout 305.70	3			3	
	4			4	
	5	Vandal Resistant 0.5 gpm (1.9 L/min.) Laminar Outlet	24.10	5	
	6	Vandal Resistant 1.0 gpm (3.8 L/min.) Laminar Outlet	24.10	6	
	7			7	
	8			8	For Recessed Control Box #8, see page C144
	9			9	

Transformer to be ordered separately for Hardwire models, see page C133.
Batteries included on all battery version models.

Flow rates are at 60 PSI (414 kPa)



Model
 620TP3328TR **Price**
 318.50

**Note : Must order Rough-In Number
AND Trim Number SEPARATELY**

Code compliant applies to entire series.

620TP3328TR (shown)

ELAVT0001ARI * Rough-In ONLY with NO Mixing Valve 417.75
ELAVT0008ARI * Rough-In ONLY with Thermostatic
Mixing Valve 633.25
620TP3 TR Trim ONLY - Hardwire Operated 48.45 (Base Product Price)
621TP3 TR Trim ONLY - Battery Operated 48.45 (Base Product Price)

To complete a Trim Product Price add the prices of chosen variations (listed below) to the **Base Product Price**.
A number from each option column must be used.

ADD-ON OPTIONS (ADD THE SUFFIX TO THE END OF THE MODEL NUMBER TO CHOOSE THIS OPTION)		
-SUFFIX NUMBER	DESCRIPTION	ADD-ON TO PRICE
-BB	Battery Back-Up - available on Hardwire operated models ONLY	44.35
-SS	Brilliance® Stainless Finish	60.00

OPTIONAL COVER PLATES (ORDER SEPARATELY)		
PRODUCT NO.	DESCRIPTION	PRICE
061269A 061269SS	4" Cover Plate	64.30 77.15
061270A 061270SS	8" Cover Plate	112.50 133.90

Electronics

SPOUT AND SENSOR		OUTLET		CONTROL BOX	
	0		0	For Surface Mount Control Box #0, see page C143	0
	1	Vandal Resistant 2.2 gpm (8.3 L/min.) Laminar Outlet	24.10	Recessed Mount with 10" x 10" Box - No Mixing Valve (1) Requires separate purchase of ELAVT0001ARI	52.25
	2	Vandal Resistant 1.5 gpm (5.7 L/min.) Laminar Outlet	24.10		
Single Hole Deck Mount Gooseneck Spout	202.00				
	3				
	4				
	5	Vandal Resistant 0.5 gpm (1.9 L/min.) Laminar Outlet	24.10		
	6	Vandal Resistant 1.0 gpm (3.8 L/min.) Laminar Outlet	24.10		
	7				
	8			Recessed Mount with 10" x 10" Box with Thermostatic Mixing Valve (1) Requires separate purchase of ELAVT0008ARI	43.95
	9				

(1) Connection from box to spout not supplied.
Transformer to be ordered separately for Hardwire models, see page C133.
Batteries included on all battery version models.

Flow rates are at 60 PSI (414 kPa)

DELTA COMMERCIAL TECHNICAL SERVICE 1-877-509-2680
 ONLINE CATALOGS: www.deltacommercialfaucets.com (Core products ONLY)
www.specselect.com (Complete Product Offering & Part Numbering System)



630TP320 (shown)

Model

630TP320

Price

583.30

Note : Available as complete models ONLY

Code compliant applies to entire series.

ADD-ON OPTIONS (ADD THE SUFFIX TO THE END OF THE MODEL NUMBER TO CHOOSE THIS OPTION)		
-SUFFIX NUMBER	DESCRIPTION	ADD-ON TO PRICE
-BB	Battery Back-Up - available on Hardwire operated models ONLY	44.35
-SS	Brilliance® Stainless Finish	60.00

OPTIONAL COVER PLATES (ORDER SEPARATELY)		
PRODUCT NO.	DESCRIPTION	PRICE
061305A	4" Cover Plate	76.55
061305SS		83.90

630TP3

Hardwire Operated

48.45 (Base Product Price)

631TP3

Battery Operated

48.45 (Base Product Price)

To complete a Product Price add the prices of chosen variations (listed below) to the **Base Product Price**.
A number from each option column must be used.

SPOUT AND SENSOR		OUTLET		CONTROL BOX	
	0			0	Base Model with Surface Mount Housing - No Mixing Valve 204.25
	1			1	For Recessed Control Box #1, see page C146
	2	Vandal Resistant 1.5 gpm (5.7 L/min.) Laminar Outlet	24.10	2	
Single Hole Deck Mount Ara® Spout	3			3	
					306.50
	4			4	
	5	Vandal Resistant 0.5 gpm (1.9 L/min.) Laminar Outlet	24.10	5	
	6			6	
	7			7	
	8			8	For Recessed Control Box #8, see page C146
	9	Vandal Resistant 0.35 gpm (1.32 L/min.) Non- Aerating Spray Outlet	24.10	9	

Transformer to be ordered separately for Hardwire models, see page C133.
Batteries included on all battery version models.

Flow rates are at 60 PSI (414 kPa)

Electronics



Model
630TP358TR **Price**
318.50

Note : Must order Rough-In Number AND Trim Number SEPARATELY

Code compliant applies to entire series.

630TP358TR (shown)

ELAVT0001ARI * Rough-In ONLY with NO Mixing Valve 417.75
ELAVT0008ARI * Rough-In ONLY with Thermostatic Mixing Valve 633.25
630TP3 TR Trim ONLY - Hardwire Operated 48.45 (Base Product Price)
631TP3 TR Trim ONLY - Battery Operated 48.45 (Base Product Price)

To complete a Trim Product Price add the prices of chosen variations (listed below) to the **Base Product Price**.
A number from each option column must be used.

ADD-ON OPTIONS (ADD THE SUFFIX TO THE END OF THE MODEL NUMBER TO CHOOSE THIS OPTION)		
-SUFFIX NUMBER	DESCRIPTION	ADD-ON TO PRICE
-BB	Battery Back-Up - available on Hardwire operated models ONLY	44.35
-SS	Brilliance® Stainless Finish	60.00

OPTIONAL COVER PLATES (ORDER SEPARATELY)		
PRODUCT NO.	DESCRIPTION	PRICE
061305A	4" Cover Plate	76.55
061305SS		83.90

Electronics

SPOUT AND SENSOR		OUTLET		CONTROL BOX	
	0			For Surface Mount Control Box #0, see page C145	0
	1			Recessed Mount with 10" x 10" Box - No Mixing Valve (1) Requires separate purchase of ELAVT0001ARI	1
	2	Vandal Resistant 1.5 gpm (5.7 L/min.) Laminar Outlet	24.10		2
202.00	3				3
	4				4
	5	Vandal Resistant 0.5 gpm (1.9 L/min.) Laminar Outlet	24.10		5
	6				6
	7				7
	8			Recessed Mount with 10" x 10" Box with Thermostatic Mixing Valve (1) Requires separate purchase of ELAVT0008ARI	8
	9	Vandal Resistant 0.35 gpm (1.32 L/min.) Non-Aerating Spray Outlet	24.10		9

(1) Connection from box to spout not supplied.
Transformer to be ordered separately for Hardwire models, see page C133.
Batteries included on all battery version models.

Flow rates are at 60 PSI (414 kPa)

DELTA COMMERCIAL TECHNICAL SERVICE 1-877-509-2680
ONLINE CATALOGS: www.deltacommercialfaucets.com (Core products ONLY)
www.specselect.com (Complete Product Offering & Part Numbering System)



860T167



Model

* - Stock Item

- 860T167
- 861T167

Price

- 1,272.65
- 1,272.65

Note : Available as complete models ONLY



ADD-ON OPTIONS (ADD THE SUFFIX TO THE END OF THE MODEL NUMBER TO CHOOSE THIS OPTION)		
-SUFFIX NUMBER	DESCRIPTION	ADD-ON TO PRICE
-BB	Battery Back-Up - available on Hardwire operated models ONLY	44.35

- 860T1
- 861T1

Hardwire Operated
Battery Operated

To complete a Trim Product Price add the prices of chosen variations (listed below).
A number from each option column must be used.

	SHOWER		CONTROL SENSOR BOX	
	Specify "0" when no shower required. (1)	0		0
		1		1
		2		2
	Showerhead, Arm & Set Screw Flange 20.75	3	Recessed Mount with 8" Box - No Mixing Valve 712.10	3
		4		4
	Handshower with 2 Check Valves, 610 mm (24") S/S Bar with ADA Slide 252.75	5		5
	30° Vandal Resistant, Cast Flow Control Wallmount Showerhead 193.00	6	Components only UNASSEMBLED 4" Box - No Mixing Valve 439.90	6
	30° Vandal Resistant, Forged Brass Wallmount Showerhead 193.00	7	Recessed Mount with 10" Box and Pressure Balance Mixing Valve 1,079.65	7
		8	Recessed Mount with 10" Box and Thermostatic Mixing Valve 1,079.65	8
		9		9

Electronics

Transformer to be ordered separately for Hardwire models, see Page C133.

Batteries included on all battery version models.

See next page for Add-On Options for the 860T Series.

(1) #7 control box pressure balance valve rated at minimum 1.25 gpm (4.7 L/min), @ 45 psi (310 kPa).

#8 control box thermostatic valve rated at minimum 0.34 gpm (1.29 L/min), @ 45 psi (310 kPa).

DELTA COMMERCIAL TECHNICAL SERVICE 1-877-509-2680
ONLINE CATALOGS: www.deltacommercialfaucets.com (Core products ONLY)
www.specselect.com (Complete Product Offering & Part Numbering System)

Price additions for Add-On Options:

- To complete an Add-On Option Product Price add the prices of the chosen variations (listed below). A number from the Hose and Slide Bar columns must always be selected, even if it is "0".

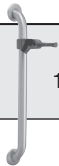
HOSE		SLIDE BAR	
Always use "0" if No selection is required from this column	0	Always use "0" if No selection is required from this column	0
	1		1
1753 mm (69") Long CP stainless steel hose (1) -stretches to 92"	2		2
 Add 32.55	3		3
	4		4
		 Add 17.15	5
		914 mm (36") S/S Slide Bar (2)	

Electronics

Notes:

- (1) **Base Product** for the **HOSE, ETC.** must include **SHOWER** option **No. 5**
- (2) **Base Product** for S/S Slide Bar must include **SHOWER** option **No. 5**

HOW TO SELECT AND SPECIFY ADD-ON OPTIONS:

Example No. 1: Base Product selected is 860T153, 36" S/S Slide Bar Add-On Suffix Number is -05
Model Number to Specify: 860T153-05

PRICING:

EXAMPLE	(1) BASE PRODUCT PRICE	PLUS	(2) ADD-ON OPTION NO. ADD-ON PRICE	EQUALS	(3) END MODEL NUMBER MODEL PRICE
No. 1	860T153 964.85	+	-05 ADD 17.15	=	860T153-05 982.00



1501T3470 (shown)



Model	Price
1500T3420	691.50
1501T3420	691.50

Supplementary Products
Deck Mount Mixing Valve for Control Box #0

24T3003 with 6" handle	218.85
24T3001 with 2 3/4" handle	211.60

ADD-ON OPTIONS (ADD THE SUFFIX TO THE END OF THE MODEL NUMBER TO CHOOSE THIS OPTION)		
-SUFFIX NUMBER	DESCRIPTION	ADD-ON TO PRICE
-BB	Battery Back-Up - available on Hardwire operated models ONLY.	44.35
-KS	3-Position Switch	196.30

Note : Available as complete models ONLY

Code compliant applies to entire series.

1500T3 **0 Hardwire Operated 103.65 (Base Product Price)**

1501T3 **0 Battery Operated 103.65 (Base Product Price)**

To complete a Product Price for the above, add the prices of the chosen variations (listed below) to the **Base Product Price**.

A number from each option column must be used.

SPOUT AND SENSOR		OUTLET		CONTROL BOX	
	0		0	Base Model with Surface Mount Housing - No Mixing Valve 363.95	0
	1	Smooth End Laminar Flow Control in Base of Gooseneck Spout 2.2 gpm (8.3 L/min.) 24.10	1	For Recessed Control Box #1, see page C150	1
	2	Vandal Resistant 1.5 gpm (5.7 L/min.) Laminar w/Agion® Antimicrobial 24.10	2		2
(Std is R5) Single Hole Deck Mount Fixed Gooseneck Spout with Integral Sensor in Base (1) 136.55	3	Vandal Resistant 1.5 gpm (5.7 L/min.) Flow Control Aerator 14.80	3		3
(Std is R5) Deck Mount Fixed Gooseneck Spout with Integral Sensor in Base and 4" Cover Plate (1) 199.80	4		4		4
(Std is R5) Deck Mount Fixed Gooseneck Spout with Integral Sensor in Base and 8" Cover Plate (1) 217.75	5		5		5
	6		6		6
	7	Smooth End, Laminar Flow Control in Base of Gooseneck Spout 1.5 gpm (5.7 L/min.) 24.10	7		7
	8	Smooth End, Laminar Flow Control in Base of Gooseneck Spout 0.5 gpm (1.9 L/min.) 24.10	8	For Recessed Control Box #8, see page C150	8
	9		9		9

Electronics

(1) Optional Spouts R3, R7 and R35 **only** available in this series due to fixed gooseneck supplied. See page C97 for **Optional Fixed Spouts**.

Flow rates are at 60 PSI (414 kPa)

Transformer to be ordered separately for Hardwire models, see page C133.

Batteries included on all battery version models.

DELTA COMMERCIAL TECHNICAL SERVICE 1-877-509-2680
ONLINE CATALOGS: www.deltacommercialfaucets.com (Core products ONLY)
www.specselect.com (Complete Product Offering & Part Numbering System)



Model	Price
1500T3478TR	379.75
1501T3478TR	379.75

Note : Must order Rough-In Number AND Trim Number SEPARATELY

ADD-ON OPTIONS (ADD THE SUFFIX TO THE END OF THE TRIM MODEL NUMBER TO CHOOSE THIS OPTION)		
-SUFFIX NUMBER	DESCRIPTION	ADD-ON TO PRICE
-BB	Battery Back-Up - available on Hardwire operated models ONLY.	44.35
-KS	3-Position Switch	196.30

Code compliant applies to entire series.

1501T3478TR (shown)

ELAVT0001ARI *	Rough-In ONLY with NO Mixing Valve	417.75
ELAVT0008ARI *	Rough-In ONLY with Thermostatic Mixing Valve	633.25
1500T3 <input type="checkbox"/> <input type="checkbox"/> <input type="checkbox"/> TR	Trim ONLY - Hardwire Operated	103.65 (Base Product Price)
1501T3 <input type="checkbox"/> <input type="checkbox"/> <input type="checkbox"/> TR	Trim ONLY - Battery Operated	103.65 (Base Product Price)

To complete a Trim Product Price for the above, add the prices of the chosen variations (listed below) to the **Base Product Price**.
A number from each option column must be used.

SPOUT AND SENSOR		OUTLET		CONTROL BOX	
	0		0	For Surface Mount Control Box #0, see page C149	0
	1	Smooth End Laminar Flow Control in Base of Gooseneck Spout 2.2 gpm (8.3 L/min.)	24.10	Recessed Mount with 10" x 10" Box - No Mixing Valve (2) Requires separate purchase of ELAVT0001ARI	1 90.95
	2	Vandal Resistant 1.5 gpm (5.7 L/min.) Laminar w/Agion® Antimicrobial	24.10		2
(Std is R5) Single Hole Deck Mount Fixed Gooseneck Spout with Integral Sensor in Base (1)	3	Vandal Resistant 1.5 gpm (5.7 L/min.) Flow Control Aerator	14.80		3
(Std is R5) Deck Mount Fixed Gooseneck Spout with Integral Sensor in Base and 4" Cover Plate (1)	4				4
(Std is R5) Deck Mount Fixed Gooseneck Spout with Integral Sensor in Base and 8" Cover Plate (1)	5				5
	6				6
	7	Smooth End, Laminar Flow Control in Base of Gooseneck Spout 1.5 gpm (5.7 L/min.)	24.10		7
	8	Smooth End, Laminar Flow Control in Base of Gooseneck Spout 0.5 gpm (1.9 L/min.)	24.10	Recessed Mount with 10" x 10" Box with Thermostatic Mixing Valve (2) Requires separate purchase of ELAVT0008ARI	8 52.20
	9				9

(1) Optional Spouts R3, R7 and R35 **only** available in this series due to fixed gooseneck supplied.
(2) Connection from box to spout not supplied.

See page C97 for **Optional Fixed Spouts**. Flow rates are at 60 PSI (414 kPa)
Transformer to be ordered separately for Hardwire models, see page C133.
Batteries included on all battery version models.



1500T4670



Model	Price
1500T4620	680.65
1500T4628	986.15
1501T4620	680.65

Note : Available as complete models ONLY

Code compliant applies to entire series.

ADD-ON OPTIONS (ADD THE SUFFIX TO THE END OF THE MODEL NUMBER TO CHOOSE THIS OPTION)		
-SUFFIX NUMBER	DESCRIPTION	ADD-ON TO PRICE
-BB	Battery Back-Up - available on Hardwire operated models ONLY	44.35

1500T4 **Hardwire Operated 112.60 (Base Product Price)**
 1501T4 **Battery Operated 112.60 (Base Product Price)**

To complete a Product Price for the above, add the prices of the chosen variations (listed below) to the **Base Product Price**.
 A number from each option column must be used.

SPOUT AND SENSOR		OUTLET		CONTROL BOX	
	0			0	Base Model with Surface Mount Housing - No Mixing Valve 395.55
	1	Smooth End Laminar Flow Control in Base of Gooseneck Spout 2.2 gpm (8.3 L/min.)	24.10	1	Recessed Mount with 10" x 10" Box - No Mixing Valve (1) 515.70
	2	Vandal Resistant 1.5 gpm (5.7 L/min.) Laminar w/Agion® Antimicrobial	24.10	2	
	3	Vandal Resistant 1.5 gpm (5.7 L/min.) Flow Control Aerator	14.80	3	
	4			4	
	5			5	
(Std is R5) Wallmount Gooseneck Spout with Integral Sensor in Base (2) 148.40	6			6	
	7	Smooth End, Laminar Flow Control in Base of Gooseneck Spout 1.5 gpm (5.7 L/min.)	24.10	7	
	8			8	Recessed Mount with 10" x 10" Box with Thermostatic Mixing Valve (1) 701.05
	9			9	

(1) Connection from box to spout **NOT** supplied.
 (2) Optional Spouts R3, R7 and R35 **only** available in this series due to fixed gooseneck supplied.

See Page C97 for **Optional Spouts**. Flow rates are at 60 PSI (414 kPa)
 Transformer to be ordered separately for Hardwire models, see Page C133.
 Batteries included on all battery version models.



3000T3470 (shown)



Model	Price
3000T3320A	782.65
3000T3370A	782.65
Supplementary Products	
Deck Mount Mixing Valve for Control Box #0	
24T3003 with 6" handle	218.85
24T3001 with 2 3/4" handle	211.60

ADD-ON OPTIONS (ADD THE SUFFIX TO THE END OF THE MODEL NUMBER TO CHOOSE THIS OPTION)		
-SUFFIX NUMBER	DESCRIPTION	ADD-ON TO PRICE
-BB	Battery Back-Up - available on Hardwire operated models ONLY.	44.35
-KS	3-Position Switch	196.30

Note : Available as complete models ONLY

Code compliant applies to entire series.

3000T3 **0 A Hardwire Operated 258.05 (Base Product Price)**

3001T3 **0 A Battery Operated 258.05 (Base Product Price)**

To complete a Product Price for the above, add the prices of the chosen variations (listed below) to the **Base Product Price**.
A number from each option column must be used.

SPOUT AND SENSOR		OUTLET		CONTROL BOX		
	0			0	Base Model with Surface Mount Housing - No Mixing Valve 363.95	0
	1			1	For Recessed Control Box #1, see page C153	1
	2	Vandal Resistant 1.5 gpm (5.7 L/min.) Laminar w/Agion® Antimicrobial	24.10	2		2
(Std is R5) Single Hole Deck Mount Fixed Gooseneck Spout with Integral Sensor in Base (1)	136.55			3	Vandal Resistant 1.5 gpm (5.7 L/min.) Flow Control Aerator	3
(Std is R5) Deck Mount Fixed Gooseneck Spout with Integral Sensor in Base and 4" Cover Plate (1)	199.80			4		4
(Std is R5) Deck Mount Fixed Gooseneck Spout with Integral Sensor in Base and 8" Cover Plate (1)	217.75			5		5
	6			6		6
	7	Smooth End, Laminar Flow Control in Base of Gooseneck Spout 1.5 gpm (5.7 L/min.)	24.10	7		7
	8	Smooth End, Laminar Flow Control in Base of Gooseneck Spout 0.5 gpm (1.9 L/min.)	24.10	8	For Recessed Control Box #8, see page C153	8
	9			9		9

(1) Optional Spouts R3, R7 and R35 **only** available in this series due to fixed gooseneck supplied. See page C97 for **Optional Fixed Spouts**.

Flow rates are at 60 PSI (414 kPa)

Transformer to be ordered separately for Hardwire models, see page C133.

Batteries included on all battery version models.

DELTA COMMERCIAL TECHNICAL SERVICE 1-877-509-2680
ONLINE CATALOGS: www.deltacommercialfaucets.com (Core products ONLY)
www.specselect.com (Complete Product Offering & Part Numbering System)



Model **Price**
 3000T3428ATR 512.15

Note : Must order Rough-In Number AND Trim Number SEPARATELY

Code compliant applies to entire series.

3000T3478ATR (shown)

ADD-ON OPTIONS (ADD THE SUFFIX TO THE END OF THE MODEL NUMBER TO CHOOSE THIS OPTION)		
-SUFFIX NUMBER	DESCRIPTION	ADD-ON TO PRICE
-BB	Battery Back-Up - available on Hardwire operated models ONLY.	44.35
-KS	3-Position Switch	196.30

- ELAVT0001ARI *** **Rough-In ONLY with NO Mixing Valve** **417.75**
- ELAVT0008ARI *** **Rough-In ONLY with Thermostatic Mixing Valve** **633.25**
- 3000T3** **ATR** **Trim ONLY - Hardwire Operated** **258.05 (Base Product Price)**
- 3001T3** **ATR** **Trim ONLY - Battery Operated** **258.05 (Base Product Price)**

To complete a Trim Product Price for the above, add the prices of the chosen variations (listed below) to the **Base Product Price**.
 A number from each option column must be used.

SPOUT AND SENSOR		OUTLET		CONTROL BOX	
	0			For Surface Mount Control Box #0, see page C152	0
	1			Recessed Mount with 10" x 10" Box - No Mixing Valve (2) Requires separate purchase of ELAVT0001ARI	1
	2	Vandal Resistant 1.5 gpm (5.7 L/min.) Laminar w/Agion® Antimicrobial	 24.10		2
<input type="checkbox"/> (Std is R5) Single Hole Deck Mount Fixed Gooseneck Spout with Integral Sensor in Base (1)	3	Vandal Resistant 1.5 gpm (5.7 L/min.) Flow Control Aerator	 14.80		3
	3				3
<input type="checkbox"/> (Std is R5) Deck Mount Fixed Gooseneck Spout with Integral Sensor in Base and 4" Cover Plate (1)	4				4
	4				4
<input type="checkbox"/> (Std is R5) Deck Mount Fixed Gooseneck Spout with Integral Sensor in Base and 8" Cover Plate (1)	5				5
	5				5
	6				6
	6				6
	7	Smooth End, Laminar Flow Control in Base of Gooseneck Spout 1.5 gpm (5.7 L/min.)	 24.10		7
	8	Smooth End, Laminar Flow Control in Base of Gooseneck Spout 0.5 gpm (1.9 L/min.)	 24.10	Recessed Mount with 10" x 10" Box with Thermostatic Mixing Valve (2) Requires separate purchase of ELAVT0008ARI	8
	9				9

(1) Optional Spouts R3, R7 and R35 **only** available in this series due to fixed gooseneck supplied.
 (2) Connection from box to spout not supplied.

See page C97 for **Optional Fixed Spouts**. Flow rates are at 60 PSI (414 kPa)
 Transformer to be ordered separately for Hardwire models, see page C133.
 Batteries included on all battery version models.



✓ Code compliant applies to entire series.

Rough-in and Trim Ordered and Priced Separately.

HARDWIRE – LAVATORY				
MODEL		DESCRIPTION	PRICE	
Rough-in	Trim		Rough-in	Trim
3000T4128ARI	3000T4128ATR	Double wallmount sensor, wallmount spout, 1.5 gpm (5.7 L/min) *	660.00	1,060.00
3000T4328ARI	3000T4328ATR	Single wallmount sensor, wallmount spout, 1.5 gpm (5.7 L/min) *	600.00	700.00

BATTERY POWERED – LAVATORY				
MODEL		DESCRIPTION	PRICE	
Rough-in	Trim		Rough-in	Trim
3001T4128ARI	3001T4128ATR	Double wallmount sensor, wallmount spout, 1.5 gpm (5.7 L/min)	660.00	1,060.00
3001T4328ARI	3001T4328ATR	Single wallmount sensor, wallmount spout, 1.5 gpm (5.7 L/min)	600.00	700.00

Flow rates are at 60 PSI (414 kPa)

ADD-ON OPTIONS (ADD THE SUFFIX TO THE END OF THE MODEL NUMBER TO CHOOSE THIS OPTION)		
-SUFFIX NUMBER	DESCRIPTION	ADD-ON TO PRICE
-BB	Battery Back-Up - available on Hardwire TR models ONLY.	44.35

RI comes complete with thermostatic mixing valve in 10" x 10" box.
Transformer to be ordered separately for hardwire models. See page C133.
Batteries included in all battery version models.

* – Stock Item

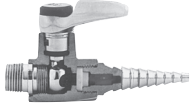
DELIVERY		Model	Description	No Shank	Standard Handle	Non-Removable Lever	Price
- W6200 GAS (Stock)							
 W6200		W6200	Ball valve hose cock with 3/8" M.I.P. inlet			✓	49.15

Laboratory Faucets, Deckmount Turrets with Hose Cocks (Ball Valve)

DELIVERY		Model	Description	Standard Shank 4.44" (L)	Standard Handle	Non-Removable Lever	Price	
- W6210 GAS (Stock) - W6220 GAS (Stock) - W6225 GAS (Stock)								
 W6210		SINGLE VALVES						
		W6210	Single ball valve hose cock, 1/4" I.P. tail			✓	109.75	
		2 VALVES AT 90 DEGREES						
		W6220	2 ball valve hose cocks @ 90 degrees, 1/4" I.P. tail			✓	166.35	
		2 VALVES AT 180 DEGREES						
		W6225	2 ball valve hose cocks @ 180 degrees, 1/4" I.P. tail			✓	166.35	

Laboratory Faucets, Wall Flange with Hose Cocks (Ball Valve)

DELIVERY		Model	Description	Standard Shank 2.38" (N)	Standard Handle	Non-Removable Lever	Price
- W6270 GAS (Stock)							
 W6270		W6270	Single ball valve hose cock with 1 1/8" wall flange, 1/4" I.P. tail			✓	92.30



SERVICE CODES	
Service	Code
Air	AIR
Argon	A
Cold Water	CW
Natural Gas	GAS
Nitrogen	N
Propane	PRO
Vacuum	VAC

Laboratory

DELIVERY	Model	Description	Price
- W6629 DW (Stock) - W6635 DW (Stock)	068128A	Repair kit for W6629 control valve	73.45
 <p>W6635</p>	W6629	Celcon control valve for pure water faucets	242.65
	W6635	Deckmount pure water faucet with combined self-closing and lock-open celcon control valve, C.P. rigid 6" gooseneck with tygon liner	391.20

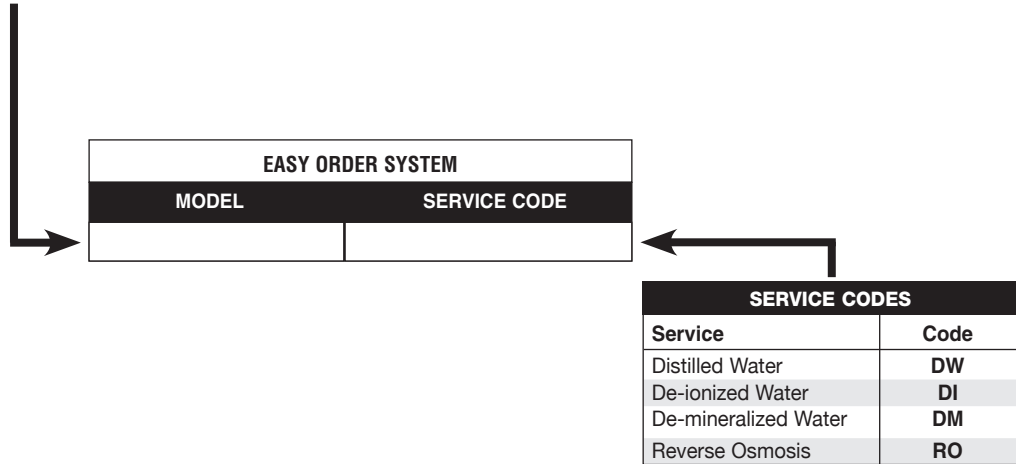

SERVICE CODES	
Service	Code
Distilled Water	DW
De-ionized Water	DI
De-mineralized Water	DM
Reverse Osmosis	RO

DELIVERY		Model	Description	Std. Handle Two Arm Metal	Std. Spout () X = Regular O = Angle VB	Price
- W6600-9 (Stock) - W6600-10 (Stock)						
 <p>W6600-10</p>	SINGLE WATER FAUCET FOR UP TO 1 1/4" DIA. HOLE					
	W6600	Deckmount compression valve with rigid/swivel gooseneck and nozzle		X (R5)		147.40
	W6600-9	As W6600 but with in-line vacuum breaker and nozzle		X (R5)		207.35
	W6600-10	As W6600 but with W6850 rigid/swivel gooseneck with angle vacuum breaker and nozzle		O (R23)		232.55
	SINGLE WATER FAUCET FOR UP TO 1 1/2" DIA. HOLE					
	W6601	Deckmount compression valve with rigid/swivel gooseneck and nozzle		X (R5)		144.80
W6601-9	As W6601 but with in-line vacuum breaker and nozzle		X (R5)		212.85	
W6601-10	As W6601 but with W6850 rigid/swivel gooseneck with angle vacuum breaker and nozzle		O (R23)		212.85	

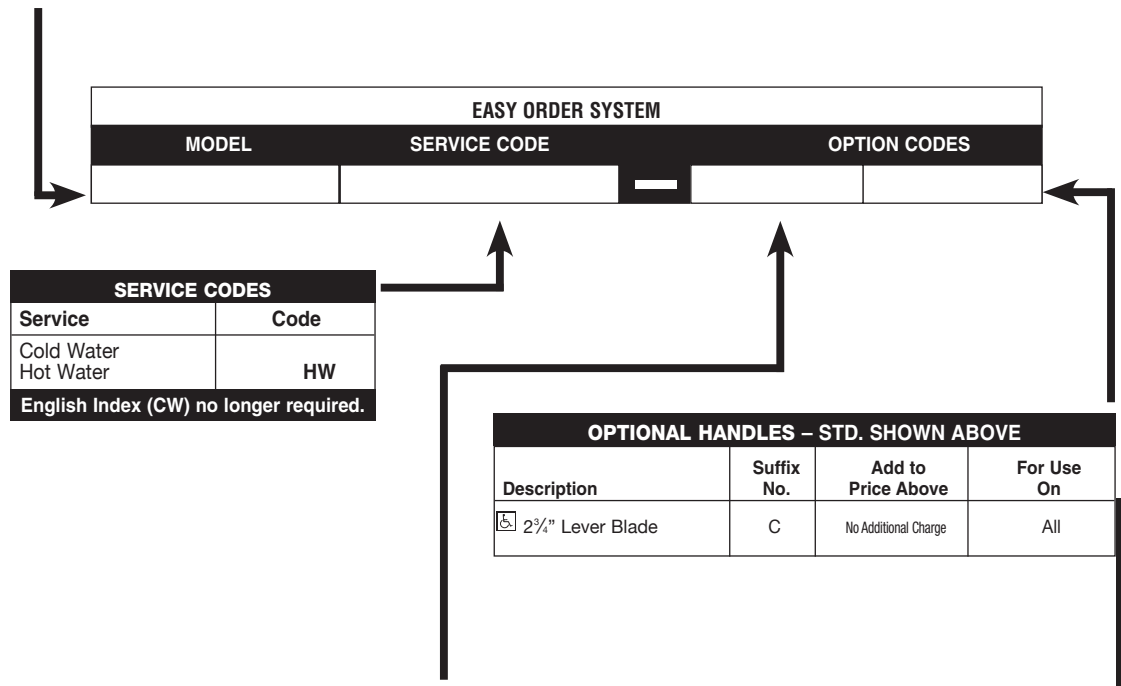

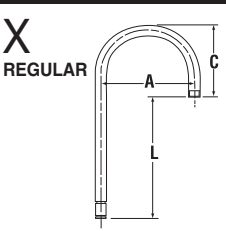
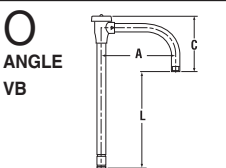
OPTIONAL SPOUTS – OPTIONAL SPOUT <u>MUST</u> BE SAME TYPE AS STD. SPOUT (I.E., REGULAR OR ANGLE VB)								
 X REGULAR	Suffix Number	"A"		"C"		"L"		ADD TO PRICE ABOVE
		mm	inches	mm	inches	mm	inches	Chrome Plated
	R2	114	4.5	104	4.1	170	6.7	5.35
	R3	152	6.0	124	4.9	56	2.2	6.80
	R4	152	6.0	124	4.9	146	5.8	5.35
	R5	152	6.0	124	4.9	188	7.4	STD
	R6	152	6.0	124	4.9	229	9	10.25
	R7	229	9.0	163	6.4	170	6.7	24.20
 O ANGLE VB	R23	152	6.0	135	5.3	188	7.4	STD

DELTA COMMERCIAL TECHNICAL SERVICE 1-877-509-2680
 ONLINE CATALOGS: www.deltacommercialfaucets.com (Core products ONLY)
www.specselect.com (Complete Product Offering & Part Numbering System)

Laboratory

DELIVERY		Model	Description	Std. Handle Two Arm Metal	Std. Spout () X = Regular O = Angle VB	Price
- W6700-9 (Stock)						
<p>W6700-9</p>	MIXING FAUCET WITH 2 3/4" Centers					
	W6700	With rigid/swivel gooseneck and nozzle outlet, inlets at 2 3/4" centers			X (R5)	228.10
	W6700-9	As W6700 but with in-line vacuum breaker and nozzle outlet			X (R5)	282.90
	W6700-10	As W6700 but with W6850 rigid/swivel gooseneck with angle vacuum breaker and nozzle			O (R23)	305.95
	MIXING FAUCET WITH 4" Centers					
	W6720	With rigid/swivel gooseneck and nozzle outlet, inlets at 4" centers, CAST body			X (R6)	177.20
	W6720-9	As W6720 but with in-line vacuum breaker and nozzle outlet			X (R6)	234.30
	W6720-10	As W6720 but with W6850 rigid/swivel gooseneck with angle vacuum breaker and nozzle			O (R23)	234.30
	MIXING FAUCET WITH 8" Centers					
W6740	Bar deck faucet w/ rigid/swivel gooseneck and nozzle outlet, inlets at 8" centers, CAST body			X (R6)	245.80	
W6740-9	As W6740 but with in-line vacuum breaker and nozzle outlet			X (R6)	300.95	
W6740-10	As W6740 but with W6850 rigid/swivel gooseneck with angle vacuum breaker and nozzle			O (R23)	300.95	

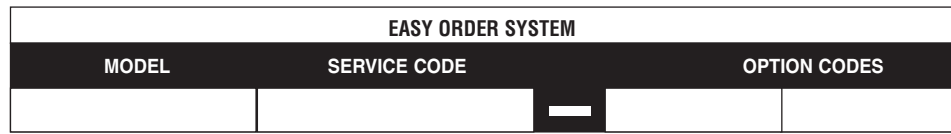

SERVICE CODES

Service	Code
Cold Water / Hot Water	
English Index (CW/HW) no longer required.	

OPTIONAL HANDLES – STD. SHOWN ABOVE

Description	Suffix No.	Add to Price Above	For Use On
2 3/4" Lever Blade	C	No Additional Charge	All

OPTIONAL SPOUTS – OPTIONAL SPOUT MUST BE SAME TYPE AS STD. SPOUT (I.E., REGULAR OR ANGLE VB)

<p>X REGULAR</p>	Suffix Number	"A"		"C"		"L"		ADD TO PRICE ABOVE
		mm	inches	mm	inches	mm	inches	Chrome Plated
<p>O ANGLE VB</p>	R2	114	4.5	104	4.1	170	6.7	5.35
	R3	152	6.0	124	4.9	56	2.2	6.80
	R4	152	6.0	124	4.9	146	5.8	5.35
	R5	152	6.0	124	4.9	188	7.4	6.80
	R6	152	6.0	124	4.9	229	9	10.25
	R7	229	9.0	163	6.4	170	6.7	24.20
	R23	152	6.0	135	5.3	188	7.4	STD

DELTA COMMERCIAL TECHNICAL SERVICE 1-877-509-2680
 ONLINE CATALOGS: www.deltacommercialfaucets.com (Core products ONLY)
www.specselect.com (Complete Product Offering & Part Numbering System)

 W6760-9	Model	Description	Std. Handle Two Arm Metal	Std. Spout () X = Regular O = Angle VB	Price
	W6760	Single Shank mixing with rigid/swivel gooseneck & nozzle outlet		X (R5)	262.65
	W6760-9	As W6760 but with in-line vacuum breaker and nozzle outlet		X (R5)	314.95
	W6760-10	As W6760 but with W6850 rigid/swivel gooseneck with angle vacuum breaker & nozzle outlet		O (R23)	336.70

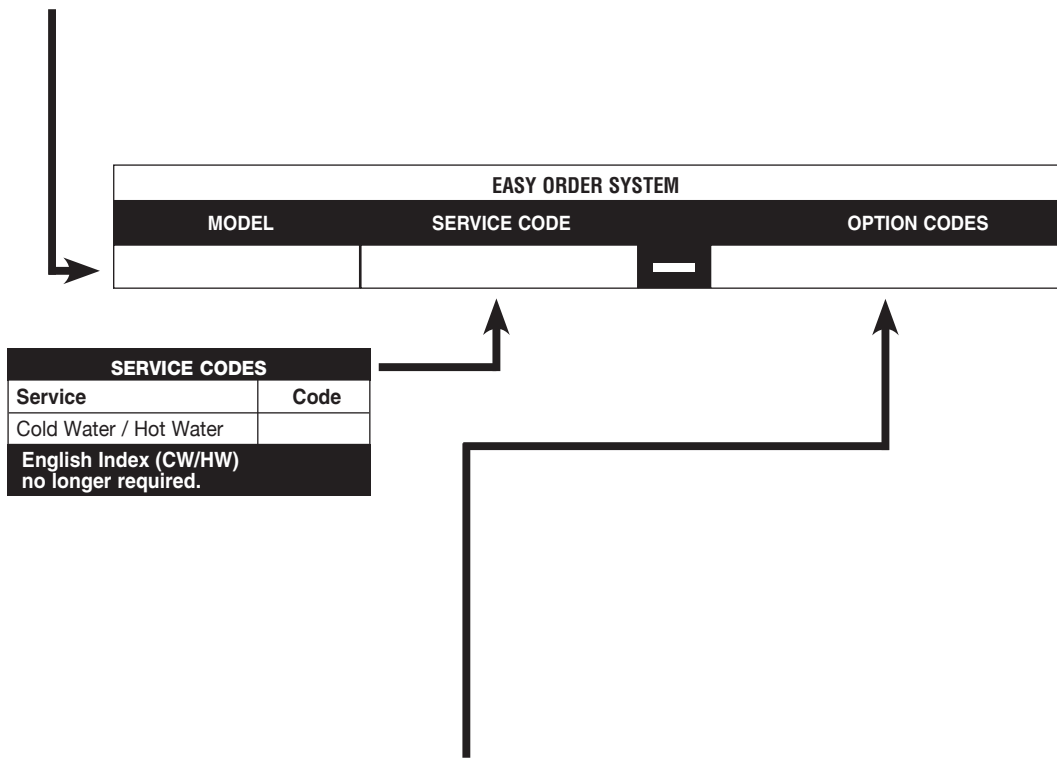

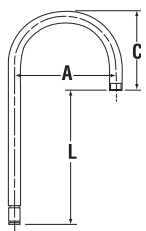
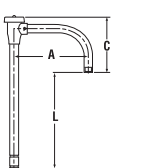
OPTIONAL SPOUTS - OPTIONAL SPOUT <u>MUST</u> BE SAME TYPE AS STD. SPOUT (I.E., REGULAR OR ANGLE VB)									
X REGULAR		Suffix Number	"A"		"C"		"L"		ADD TO PRICE ABOVE
			mm	inches	mm	inches	mm	inches	Chrome Plated
		R2	114	4.5	104	4.1	170	6.7	5.35
		R3	152	6.0	124	4.9	56	2.2	6.80
		R4	152	6.0	124	4.9	146	5.8	5.35
		R5	152	6.0	124	4.9	188	7.4	STD
		R6	152	6.0	124	4.9	229	9	10.25
		R7	229	9.0	163	6.4	170	6.7	24.20
O ANGLE VB		R23	152	6.0	135	5.3	188	7.4	STD

DELTA COMMERCIAL TECHNICAL SERVICE 1-877-509-2680
 ONLINE CATALOGS: www.deltacommercialfaucets.com (Core products ONLY)
www.specselect.com (Complete Product Offering & Part Numbering System)

Laboratory

Inserts for Outlets			
MODEL	DESCRIPTION		PRICE
060686A	1.9 L/min. (0.5 gpm) Insert (pkg. of 12)	Spray	40.95
060687A	3.8 L/min. (1.0 gpm) Insert (pkg. of 12)	Spray	50.45
060688A	5.7 L/min. (1.5 gpm) Antimicrobial Laminar Flow Insert (pkg. of 12)	Laminar	101.60
060689A	5.7 L/min. (1.5 gpm) Insert (pkg. of 12)	Aerated	28.30

Outlets

FLOW	MODEL	DESCRIPTION		PRICE
1.32 L/min. (0.35 gpm)	061104A	1.32 L/min (0.35 gpm) Vandal Resistant Outlet (Male)	Spray	25.30
	061104SS	1.32 L/min (0.35 gpm) Vandal Resistant Stainless Outlet (Male)	Spray	46.85
	061105A	1.32 L/min (0.35 gpm) Vandal Resistant Outlet (Female)	Spray	29.80
	061106A	1.32 L/min (0.35 gpm) Outlet (Male)	Spray	13.95
	061107A	1.32 L/min (0.35 gpm) Outlet (Female)	Spray	13.95
1.9 L/min. (0.5 gpm)	060726A	1.9 L/min. (0.5 gpm) Vandal Resistant Outlet (Female)	Spray	29.80
	060666A	1.9 L/min. (0.5 gpm) Outlet (Female)	Spray	13.95
	060667A	1.9 L/min. (0.5 gpm) Outlet (Male)	Spray	13.95
	061203A	1.9 L/min. (0.5 gpm) Vandal Resistant Outlet (Male)	Laminar	26.35
	061203SS	1.9 L/min. (0.5 gpm) Vandal Resistant Stainless Outlet (Male)	Laminar	35.55
	061204A	1.9 L/min. (0.5 gpm) Vandal Resistant Outlet (Female)	Laminar	26.35
	RP31704	1.9 L/min. (0.5 gpm) Vandal Resistant Outlet (Male)	Spray	24.10
	RP31704SS	1.9 L/min. (0.5 gpm) Vandal Resistant Stainless Outlet (Male)	Spray	75.90
3.8 L/min. (1.0 gpm)	060663A	3.8 L/min. (1.0 gpm) Vandal Resistant Outlet (Female)	Spray	27.25
	060566A	3.8 L/min. (1.0 gpm) Vandal Resistant Outlet (Male)	Spray	27.25
	060664A	3.8 L/min. (1.0 gpm) Outlet (Female)	Spray	13.95
	060665A	3.8 L/min. (1.0 gpm) Outlet (Male)	Spray	13.95
	060941A	3.8 L/min. (1.0 gpm) Outlet (Female)	Aerated	13.25
	060940A	3.8 L/min. (1.0 gpm) Outlet (Male)	Aerated	13.95
	060940SS	3.8 L/min. (1.0 gpm) Stainless Outlet (Male)	Aerated	45.85
	061176A	3.8 L/min. (1.0 gpm) Vandal Resistant Outlet (Male)	Laminar	28.75
	061177A	3.8 L/min. (1.0 gpm) Vandal Resistant Outlet (Female)	Laminar	28.75
5.7 L/min. (1.5 gpm)	060637A	5.7 L/min. (1.5 gpm) Antimicrobial Laminar Flow Vandal Resistant Outlet (Female)	Laminar	29.80
	060638A	5.7 L/min. (1.5 gpm) Antimicrobial Laminar Flow Vandal Resistant Outlet (Male)	Laminar	29.80
	060638SS	5.7 L/min. (1.5 gpm) Antimicrobial Laminar Flow Vandal Resistant Stainless Outlet (Male)	Laminar	40.90
	060639A	5.7 L/min. (1.5 gpm) Vandal Resistant Outlet (Female)	Aerated	18.30
	060640A	5.7 L/min. (1.5 gpm) Vandal Resistant Outlet (Male)	Aerated	18.30
	060641A	5.7 L/min. (1.5 gpm) Outlet (Female)	Aerated	13.95
	060642A	5.7 L/min. (1.5 gpm) Outlet (Male)	Aerated	13.95
5.7 L/min. (1.5 gpm)	061178A	5.7 L/min. (1.5 gpm) Swivel Outlet M24x1 (Male)	Laminar	26.35
	061118A	5.7 L/min. (1.5 gpm) Antimicrobial Outlet M24x1 (Male)	Laminar	28.75
8.3 L/min. (2.2 gpm)	060719A	8.3 L/min. (2.2 gpm) Outlet (Female)	Aerated	13.95
	060720A	8.3 L/min. (2.2 gpm) Outlet (Male)	Aerated	13.95
	060721A	8.3 L/min. (2.2 gpm) Vandal Resistant Outlet (Female)	Laminar	29.80
	060723A	8.3 L/min. (2.2 gpm) Vandal Resistant Outlet (Female)	Aerated	18.30
	060724A	8.3 L/min. (2.2 gpm) Vandal Resistant Outlet (Male)	Aerated	18.30

Notes: Female thread 55/64" dia - 27 threads/inch Male thread 15/16" dia - 27 threads/inch

DELTA COMMERCIAL TECHNICAL SERVICE 1-877-509-2680
ONLINE CATALOGS: www.deltacommercialfaucets.com (Core products ONLY)
www.specselect.com (Complete Product Offering & Part Numbering System)

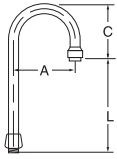

GROUP NO. 1
Regular Gooseneck

Rigid/Swivel Model ONLY	Rigid/Swivel Price	Limited Swing Model ONLY	Limited Swing Price	"A"		"C"		"L"		"ADD-ON" SUFFIX NO.	RIGID/SWIVEL SPOUT DESCRIPTION
				MM	IN.	MM	IN.	MM	IN.		
063092A	72.00	—	—	89	3.5	51	2	173	6.8	R1	Gooseneck Spout
063087A	51.15	063063A	73.75	114	4.5	104	4.1	170	6.7	R2	Gooseneck Spout
063093A	74.10	063064A	114.15	152	6	124	4.9	56	2.2	R3	Gooseneck Spout
063088A	55.80	063065A	79.35	152	6	124	4.9	146	5.8	R4	Gooseneck Spout
063089A	59.85	063066A	85.90	152	6	124	4.9	188	7.4	R5	Gooseneck Spout
063090A	59.85	063067A	86.45	152	6	124	4.9	229	9	R6	Gooseneck Spout
063091A	66.30	063068A	100.05	229	9	163	6.4	170	6.7	R7	Gooseneck Spout
063094A	76.35	063069A	113.40	229	9	163	6.4	348	13.7	R8	Gooseneck Spout
061006A	58.65	061007A	83.30	152	6	124	4.9	94	3.7	R35	Gooseneck Spout

Note: Contact customer service for 1500T and 3000T Series Fixed Spouts.

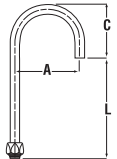

GROUP NO. 2
Smooth End-Flow Control
In Base of Gooseneck
Spout
(Available on #7 outlets ONLY)

060878A	58.10	063070A	79.85	114	4.5	97	3.8	178	7	R2	Gooseneck Spout w/FC
060876A	82.00	063071A	120.30	152	6	117	4.6	64	2.5	R3	Gooseneck Spout w/FC
060872A	62.85	063072A	85.35	152	6	117	4.6	152	6	R4	Gooseneck Spout w/FC
060873A	67.15	063073A	92.00	152	6	117	4.6	196	7.7	R5	Gooseneck Spout w/FC
060874A	67.15	063074A	92.70	152	6	117	4.6	236	9.3	R6	Gooseneck Spout w/FC
060875A	73.95	063075A	105.65	229	9	155	6.1	178	7	R7	Gooseneck Spout w/FC
060877A	80.35	063076A	119.50	229	9	155	6.1	356	14	R8	Gooseneck Spout w/FC
060540A	59.85	063077A	85.35	152	6	117	4.6	102	4	R35	Gooseneck Spout w/FC

Note: Contact customer service for 1500T and 3000T Series Fixed Spouts.

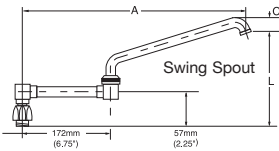

GROUP NO. 4 Double Joint

063015A & 060452A	116.65 / 29.50	—	—	309	12.2	38	1.5	175	6.9	R16	Double Joint Spout
063015A & 060269A	116.65 / 50.40	—	—	359	14.1	38	1.5	218	8.6	R17	Double Joint Spout
063015A & 060455A	116.65 / 62.85	—	—	448	17.6	29	1.1	175	6.9	R18	Double Joint Spout

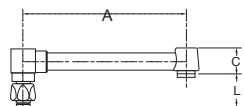

GROUP NO. 5 Plain Spout

060805A	158.95	—	—	81	3.2	33	1.3	38	1.5	R27	Plain Spout
060806A	236.10	—	—	203	8	33	1.3	38	1.5	R19	Plain Spout
060271A	110.65	—	—	89	3.5	33	1.3	43	1.7	R28	Plain VB Spout
060754A	314.80	—	—	203	8	33	1.3	43	1.7	R20	Plain VB Spout

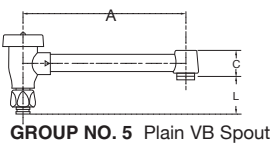

GROUP NO. 5 Plain VB Spout

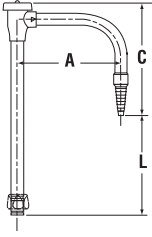
 ANGLE VB	Model	"A" inches		"C" inches		"L" inches		Add-On Suffix #	Price
	W6850	152	6.0	173	6.8	137	5.4	R23	140.00
W6850-1	152	6.0	173	6.8	97	3.8	R22	140.00	
W6850-8	203	8.0	173	6.8	137	5.4	R24	140.15	
W6850-9	229	9.0	173	6.8	137	5.4	R25	144.65	
W6850-12	305	12.0	173	6.8	137	5.4	R26	148.45	

Laboratory Special Replacement Rigid/Swivel Goosenecks (Separate Orders)

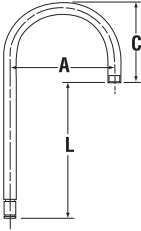
 REGULAR	Model	"A" inches		"C" inches		"L" inches		Add-On Suffix #	Price
	W6890-1	114	4.5	104	4.1	170	6.7	R2	63.80
W6890-7	152	6.0	124	4.9	56	2.2	R3	95.60	
W6890-2	152	6.0	124	4.9	146	5.8	R4	71.35	
W6890	152	6.0	124	4.9	188	7.4	R5	71.35	
W6890-4	152	6.0	124	4.9	229	9	R6	77.80	
W6890-5	229	9.0	163	6.4	170	6.7	R7	95.65	
W6890-8	229	9.0	163	6.4	348	13.7	R8	102.85	

Replacement Swing Spouts (Separate Orders)

SWING SPOUT REPAIR PART			
Model	Description	Add-on Suffix #	Price
063044A	8" "D" Section Spout	S2	56.65
060452A	6" Tubular Spout	S3	29.50
060269A	8" Tubular Spout	S5	50.40
060454A	9" Tubular Spout	S6	29.80
060455A	11" Tubular Spout	S7	62.85
060456A	14" Tubular Spout	S8	76.10
060457A	16" Tubular Spout	S9	43.60

Model	Description	Price
060003A	C.P. wall flange	11.05
060004A	C.P. 1-1/2" spud flange	16.20
060022A	Handle screws & index kit (for 'T' products) includes:	50.25
	12 – short screws	
	12 – long screws	
	12 – red indexes	
	12 – blue indexes	
	1 – driver bit	
060026A	Gooseneck spout repair parts kit includes:	32.90
	1 – rigid collar	
	6 – retaining rings	
	6 – swivel rings	
	12 – "O" rings	
	1 – spout nut	
060027A	Cross handle w/ screw, red & blue button (for 28T9)	31.00
060028A	Pkg. of 12 – set screws	13.25
	2 – allen keys	
060029A	Check unit kit (2 units)	59.05
060030A	Pkg. of 6 – "O" rings	38.25
	6 – check units	
060032A	Pkg. of 4 – springs for self-close lever handle w/ L.H. structure (cold water side)	43.60
060033A	Pkg. of 4 – springs for self-close lever handle w/ R.H. structure (hot water side) and for 5 fluted self-close handles	43.60
060034A	Stem structure complete w/ seat (for 28T9)	35.25
060037A	Pkg. of 2 – sani guards	28.00
060042A	Pkg. of 6 – plug buttons	15.45
	6 – "O" rings	
	6 – chain stay posts	
060046A	2-3/4" lever handle w/ screw red and blue index (21B)	24.00
060047A	R.H. structure, regular and long renewable seat (21B)	17.00
060048A	L.H. structure, regular and long renewable seat (21B)	17.00
060049A	Pkg. of 12 – fibre washers	16.65
	12 – rubber washers	
060051A	Pkg. of 12 – plug buttons	10.50
060052A	Pkg. of 24 – spout "O" rings	12.85
060056A	Pail brace complete (for 28T9)	87.65
060057A	14" cover plate (9T400)	74.95
060058A	Integral stop structure complete (for 28T9)	35.85
060059A	Pkg. of 12 – "O" rings	9.20
060072A	No. 6 x 2" V.P. spanner screws (2) and driver bit	28.05
060073A	No. 10 x 2" V.P. spanner screws (4) and driver bit	32.60
060074A	Pkg. of 5 – springs	14.45
060075A	Pkg. of 5 – plastic handle inserts	7.05
060076A	Pkg. of 12 – C.P. cover screws	21.65
	1 – driver bit	
060077A	Cover and screw (non hold open model)	26.25
060078A	Pkg. of 12 – Cast cap screws	14.35
060079A	Pkg. of 12 – Diaphragms	71.60
060081A	Pkg. of 12 – Plug buttons	12.20
060082A	Pkg. of 20 – "O" rings	16.00
060083A	Pkg. of 12 – Rubber washers	16.00
	12 – Fibre washers	
060094A	Hex coupling ring	10.00
060096A	Renewable seat wrenches for brass and plastic renewable seats	155.25
060115A	3/4" dia. C.P. brass split ring hanger	58.45
060117A	1-1/2" dia. C.P. brass split ring hanger	70.75
060132A	Handshower, swivel wall mount elbow	234.15

Model	Description	Price
060132A-20	Handshower package w/ SS hose	268.35
060139A	Seat washers (24/pkg.)	10.95
060140A	Pkg. of 24 – "O" rings	14.85
060148A	Handle index package	28.50
060164A	3" single control lever handle	37.75
060193A	Controller fuse (for 2000T)	12.95
060197A	13/16" male thread aerator	9.25
060198A	Single inlet shank parts kit (for 28T9)	34.15
060239A	Wheel handle and screw	4.70
060245A	Pkg. of 6 – Retaining rings	7.20
060246A	Pkg. of 6 – Plastic collars	9.65
060253A	3/4" x 19-1/2" VB Tube	93.75
060254A	59" bedpan cleanser hose	60.55
060259A	Tempus repair parts kit	95.40
060264A	Package of 2 sani-guards	22.95
060269A	8" Tubular swing spout complete	50.40
060270A	Extension shank, tube and flange (for 16" long bottom fork bracket spout) 1 of each	83.00
060271A	3" RCP VB spout complete	110.65
060274A	Wall thermometer kit for shower	347.50
060278A	2.2 gpm (8.3 L/min) VR female laminar flow moderator outlet w/ wrench (for pre-1998 gooseneck spouts)	28.40
060279A	Vandal resistant aerator	17.35
060280A	2.2 gpm (8.3 L/min) Female aerator (for pre-1998 gooseneck spouts)	13.25
060282A	Check structures complete (2 units, pre-1998)	54.80
060302A	Vacuum breaker repair parts kit	44.85
060303A	Supply elbow/flange	28.05
060310A	Flow control & sprayplate	9.85
060311A	CP insert	20.00
060316A	1-1/2" TV CP elbow	62.15
060318A	Flow control inserts only (6/pkg.)	24.55
060329A	Cover screws	5.95
060331A	Thumbscrew and "O" ring kit	27.50
060334A	Battery holder	11.15
060341A	Wrench kit for brass renewable seat	61.75
060342A	Plug & "O" ring for handle end	19.00
060344A	Filter screen for FV (12/pkg.)	38.25
060345A	Single shank kit w/ 1.25" offset	35.40
060346A	12" flexible braided urinal hose	62.50
060354A	CP union tail 1" longer	46.00
060355A	CP union tail 2" longer	47.05
060365A	"O" ring kit (6/pkg.) for conn. lav.	23.95
060397A	6" long cover tube (for optional rough-in problems)	41.00
060400A	1-1/2" x 10" long CP VB tube	26.25
060401A	1-1/2" x 22-3/4" long CP VB tube	52.10
060402A	3/4" x 11.5" long VB tube	45.65
060409A	1-1/4" x 19.6" long trap seal tube	110.65
060412A	Body Gland	17.00
060424A	Wall spout w/ top brace bracket less VB	141.40
060428A	Deck mount assembly for rigid/swivel spouts	56.00
060434A	Metal mounting hardware	8.85
060436A	Holddown package	11.60
060437A	Holddown package (2 each locknuts, cplg. nuts, lockwashers)	8.45
060441A	#3 scrulox 8 drive bit	7.10
060444A	Locknut	5.85
060445A	CP deck flange	11.50
060446A	Fiber washer (12/pkg.)	7.90
060452A	6" tubular swing spout	29.50

Model	Description	Price
060454A	9" tubular swing spout	29.80
060455A	11" tubular swing spout	62.85
060456A	14" tubular swing spout	76.10
060457A	16" tubular swing spout	43.60
060462A	1/2" U.A.S. stop	66.15
060463A	3/4" spud nut, washers and flange pkg.	28.10
060464A	Deck flange	9.20
060465A	Rubber washer (12/pkg.)	5.05
060466A	Wall flange and set screw (2/pkg.)	52.70
060467A	Diverter	14.55
060469A	Fiber gasket kit (12/pkg.)	19.45
060473A	Optional thin wall trim kit	27.20
060475A	Soap dish w/ post	33.35
060479A	Handle & screw kit	2.65
060480A	1-1/2" x 3/4" threaded adapter	17.05
060481A	3/4" x 16" long rough tube - threaded one end	77.45
060482A	1-1/2" x 16" long rough tube - threaded one end	52.50
060485A	Wall flange and CP brass hub (2/pkg.)	33.50
060486A	1.69" long union tail	25.70
060487A	2.19" long union tail	22.80
060488A	3/4" IP coupling nut - chrome	21.35
060489A	1.75" long cover tube	9.20
060493A	"O" ring kit (6/pkg.)	17.35
060494A	Spray head hook & screw	36.50
060496A	Pre-rinse spring only	67.90
060504A	Cover tube & SS wall flange	18.85
060505A	CP cover w/ bumper seat lid	60.00
060506A	Standard adjustable tail CP	32.35
060507A	CP poppet pin for watercloset (3/pkg.)	18.50
060508A	CP poppet pin for urinal (3/pkg.)	9.90
060513A	Adapter	27.05
060514A	Optional outlet tube - 16" long	40.20
060523A	FP repair kit (1999 on)	73.45
060524A	FP repair kit (1999 on)	124.15
060540A	Gooseneck spout w/ flow control	59.85
060543A	4" hooded lever handle pkg. (1 handle, 1 screw, 1 alignment insert, red and blue indexes)	31.25
060544A	Alignment insert (12/pkg.)	17.90
060546A	4" plate and holddown package (3000TGN Series)	94.00
060547A	8" plate and holddown package (3000TGN Series)	125.90
060552A	8" CP forged deck plate	121.75
060553A	CER-TECK® structure "O" ring kit (24/pkg.)	14.35
060554A	CER-TECK® bottom seal (24/pkg.)	9.70
060556A	8" deck gasket	95.25
060564A	Single hole deck gasket	34.30
060566A	VR 1 gpm flow control non-aerating spray outlet	27.25
060570A	3/4" coupling nut & washers	14.60
060577A	12" SS cover	136.70
060583A	Balanced lever handle w/ 1 screw, 1 red and 1 blue index	42.45
060584A	Mounting hardware (1 gasket, 1 locknut)	27.15
060585A	Cover plate and mounting hardware	81.70
060586A	Flexible SS supply tubes (2/pkg.) 3/8" compression connectors	76.50
060590A	Spout w/ adj. bracket - No VB 8"	263.50
060591A	Spout w/ adj. bracket - Inline VB 8"	353.15
060592A	Spout w/ adj. bracket - Ang VB 8"	370.80
060593A	Spout w/ adj. bracket - no VB 5.5"	157.90
060594A	Spout w/ adj. bracket - Ang VB 5 3/4"	157.90

Model	Description	Price
060595A	Straight wall brace assembly	103.90
060596A	Fork wall brace assembly	191.75
060599A	3" hooded lever handle & screw	27.30
060602A	4" blade handle w/ screw, 1 red & 1 blue index, alignment insert	59.60
060605A	Toe test spout	105.65
060637A	Female V.R. 1.5 gpm (5.7 L/min) laminar w/ antimicrobial	29.80
060638A	Male V.R. 1.5 gpm (5.7 L/min) laminar w/ antimicrobial	29.80
060638SS	Male SS V.R. 1.5 gpm (5.7 L/min) laminar w/ antimicrobial	40.90
060639A	Female V.R. 1.5 gpm (5.7 L/min) flow control aerator	18.30
060640A	Male V.R. 1.5 gpm (5.7 L/min) flow control aerator	18.30
060641A	Female 1.5 gpm (5.7 L/min) std. flow control aerator	13.95
060642A	Male 1.5 gpm (5.7 L/min) std. flow control aerator	13.95
060646A	24T3 Series cam package	16.55
060647A	24T3 Series braided hose w/ 3/8" compression connection	31.70
060648A	24T3 Series inlet screen (12/pkg.)	63.90
060651A	3 position switch add-on package keyed switch	229.30
060652A	Slow close foot pedal cartridge (1999 on)	276.60
060654A	ADA metering handle (plain)	47.65
060655A	ADA metering handle (red)	50.30
060656A	ADA metering handle (blue)	50.30
060657A	4" deck gasket for 86T ADA metering (3/pkg.)	18.00
060658A	4" deck gasket for 87T151 (3/pkg.)	22.65
060660A	Checks for 060659A (6/pkg.)	24.60
060661A	Holddown pkg. for 87T single hole	5.10
060663A	Female V.R. 1.0 gpm (3.8 L/min) outlet	27.25
060664A	Female std. 1.0 gpm (3.8 L/min) outlet	13.95
060665A	Male std. 1.0 gpm (3.8 L/min) outlet	13.95
060666A	Female std. 0.5 gpm (1.9 L/min) outlet	13.95
060667A	Male std. 0.5 gpm (1.9 L/min) outlet	13.95
060671A	3/4" NPS solenoid valve	66.65
060673A	10" x 10" stainless cover w/ override	145.80
060674A	14" x 14" stainless cover w/ override	174.30
060675A	14" x 20" stainless cover w/ override	195.40
060676A	Sensor module - washdown urinal	288.35
060677A	Sensor module - urinal FV	288.35
060678A	Sensor module - watercloset FV	288.35
060679A	Override button	72.30
060680A	Solenoid extension cable 48" (1600T)	22.30
060681A	Battery holder (1600T) 4 C cells fla	11.30
060683A	24 VAC to 6 VDC converter	46.80
060684A	Battery holder (1600T) 4 C cells Sq	16.00
060685A	Ferrite bead for electronic series	31.80
060686A	0.5 gpm (1.9 L/min) insert only	40.95
060687A	1.0 gpm (3.8 L/min) insert only	50.45
060688A	1.5 gpm (5.7 L/min) antimicrobial	101.60
060689A	1.5 gpm (5.7 L/min) insert only	28.30
060690A	36" cable extension	34.65
060691A	Tube, urinal	20.60
060692A	Adj. TV ret. ring	3.25
060693A	CP oscillating handle	14.20
060694A	3/4" C adaptor	13.85
060695A	TV guide screw gasket	2.50
060696A	1/2" C X MIP adaptor	4.15
060697A	1" copper inlet adaptor	16.55
060698A	3/8" IP X M Aerator thd adaptor	16.40
060701A	CP outlet adaptor	32.35
060702A	CP 1/2" NPS adaptor	35.90

DELTA COMMERCIAL TECHNICAL SERVICE 1-877-509-2680
ONLINE CATALOGS: www.deltacommercialfaucets.com (Core products ONLY)
www.specselect.com (Complete Product Offering & Part Numbering System)

Model	Description	Price
060703A	CP 1/2" x 3/8" IP bushing	4.35
060704A	20VA transformer	57.00
060705A	CP diverter spout	46.15
060706A	Check tail S/A	41.45
060707A	1-1/2" CP cplg. nut S/A	14.60
060708A	CP 3/8" FIP x 3/8" FIP VB	108.90
060709A	1/2" angle vac breaker	90.90
060710A	Shower arm trim S/A	35.25
060711A	3/8" IPS set screw FLG S/A	25.95
060712A	Remotrol parts pkg.	33.90
060713A	Female VP rose spray S/A	38.15
060715A	Straight VB	59.60
060716A	Wall mounted vacuum breaker	171.20
060718A	Bracket holder S/A	40.45
060719A	Aerator, female, .859 THD, 2.2 gpm	13.95
060720A	Aerator, male, .937 THD, 2.2 gpm	13.95
060721A	Moderator, female, 2.2 gpm	29.80
060722A	Moderator, Male, 2.2 gpm	28.60
060723A	VP aerator (female) & key S/A, 2.2 gpm	18.30
060724A	VP aerator (male) & key S/A, 2.2 gpm	18.30
060726A	VP aerator (0.5 gpm), Female, S/A	29.80
060728A	Bedpan cleanser w/ stop	210.90
060729A	Bedpan cleanser LESS stop	131.90
060730A	CP TECK line vacuum breaker	50.55
060734A	CP VB coupling nut	40.05
060735A	CP union nut	10.95
060745A	1-1/4" TV lockring S/A	40.00
060754A	Plain VB spout S/A	314.80
060755A	Cage & P.B. S/A	50.25
060756A	Flange & pin S/A	44.80
060757A	CP 3/8" IP angle VB	59.30
060759A	CP 3/8" IP nipple 1.5 IN L	26.00
060761A	RCP 3/8" IP nipple 3.5 IN L	18.30
060762A	RCP 3/8" IP nipple 5 IN L	21.60
060764A	1 x 3/4" MIP X FIP flush bushing	24.00
060765A	VP aerator key	5.15
060767A	Aqua Controller	727.50
060768A	Short range WP sensor 39" L	678.00
060769A	Long range WP sensor 39" L	678.00
060771A	40VA transformer	58.00
060772A	100VA transformer	153.05
060773A	1-1/4" SJ nut S/A	11.05
060777A	1-1/2" TV offset VB & coupling Ring	219.25
060778A	1-1/2" RGH coupling nut S/A	7.30
060779A	Diaphragm & guide S/A	30.60
060781A	1 1/2" TV outlet tube & tee S/A	87.30
060782A	TECK II 1-1/2" x 10" CP VB S/A	58.80
060783A	TECK II 1-1/2" x 22-3/4" CP VB S/A	114.20
060784A	TECK II 3/4" x 11-1/2" CP VB S/A	86.30
060785A	VB sleeve M.O.	13.40
060789A	Aerator x 3/8" MIP adaptor	49.20
060790A	Aerator x 1/2" MIP adaptor	45.70
060791A	Hose end VB S/A	50.55
060792A	Spout & flange S/A	120.10
060793A	30 deg. inst. shower head S/A	190.95
060794A	TECK® fluted handle & screw S/A	31.00
060796A	VB for 81T281 AM - gray S/A	105.75
060797A	Plastic bumper & screw S/A	6.15

Model	Description	Price
060798A	Vacuum breaker S/A w/ gasket	42.00
060799A	Universal TV washer repair kit	18.95
060801A	Universal TV handle kit	74.00
060803A	Spout w/ VB outlet S/A	204.05
060804A	1/2" Female hose X aerator thread adapter	16.10
060805A	Short spout S/A	158.95
060806A	Plain rigid spout S/A	236.10
060809A	Lever handle & screw S/A	19.30
060810A	Handle cage S/A	22.90
060815A	Osc. handle & flange S/A	58.90
060816A	1-3/8" PB & flange S/A	112.25
060819A	Stream straightener & VP key	34.05
060820A	Set screw flange S/A	23.00
060822A	PB control unit Complete	200.00
060825A	Handle. gland & sleeve S/A	15.25
060826A	Bedpan structure	72.60
060829A	Pair check stop cartridges	42.40
060838A	Push Button Metering Lavatory Retrofit Kit	79.40
060841A	Push button & set screw kit	21.20
060843A	Retrofit kit - TECK II exposed	34.45
060844A	Repair kit - check/stop	5.10
060845A	Retrofit kit - TECK II concealed	36.15
060848A	SC cartridge kit	41.45
060851A	UR & WC Poppet Pin Kit	4.65
060858A	Vacuum breaker insert	4.65
060859A	1" CP UAS stop assembly	130.05
060860A	CP UAS L/nut & tail S/A	102.30
060861A	Outlet tube washer set	7.45
060862A	1" Conc UAS complete	138.90
060863A	1-1/4" x 10" CP TECK II VB complete	87.90
060864A	4" blade handle & screw sub-assembly	36.55
060865A	6" wrist handle & screw S/A	44.10
060872A	Flow control gooseneck spout	62.85
060873A	Flow control gooseneck spout	67.15
060874A	Flow control gooseneck spout	67.15
060875A	Flow control gooseneck spout	73.95
060876A	Flow control gooseneck spout	82.00
060877A	Flow control gooseneck spout	80.35
060878A	Flow control gooseneck spout	58.10
060880A	Handle control unit & bracket	143.65
060894A	RGH BR drain plug & gasket	3.55
060895A	CP 1-1/2" x 16" tube	93.20
060896A	CP 1-1/2" x 6.62" L tube	66.05
060897A	Anchor plate & cap S/A	32.60
060898A	Cover screws & driver bit for 81T	9.15
060899A	CP metal cover, screws & bit for 81T	103.70
060901A	12" solenoid extension cord for 81T	12.90
060902A	36" solenoid extension cord for 81T	19.20
060905A	Cover gasket	6.60
060906A	Surface mount housing	22.90
060907A	Driver board	169.00
060908A	Solenoid holder	2.60
060909A	Screen assembly	1.45
060911A	Mechanical mixing valve assembly	108.45
060917A	Lotion w/ moisturizers soap refill	36.30
060918A	Soap dispenser plug-In transformer	68.05
060919A	Soap dispenser 24 VAC to 6 VDC converter	61.15
060920A	Complete brass flow housing & contr	14.00

DELTA COMMERCIAL TECHNICAL SERVICE 1-877-509-2680
ONLINE CATALOGS: www.deltacommercialfaucets.com (Core products ONLY)
www.specselect.com (Complete Product Offering & Part Numbering System)

Model	Description	Price
060922A	Replacement faceplates - 1.2, 1.6 & 3.3 gpm (4.5, 6 & 12.5 L/min) one of each	35.00
060923A	Nuts for 1600T recessed (12/pkg.)	39.35
060924A	Retrofit kit for 1000T6 WC w/ 12" FR	583.25
060925A	Retrofit kit for 1000T6 WC w/ 4" Box	560.85
060926A	Retrofit kit for 1000T6 UR w/ 12" frame	583.25
060927A	Retrofit kit for 1000T6 UR w/ 4" Box	560.85
060928A	Retrofit kit for 1000T9 washdown w/ 10" frame	410.50
060931A	E-soap spout assembly metal	401.95
060932A	Spacer & adhesive washer package	22.00
060933A	Lock washer & mounting nut	5.60
060934A	Bottle clip (3/pkg.)	7.90
060935A	C-clip (3/pkg.)	7.90
060936A	Motor housing assembly	202.00
060940A	1.0 gpm (3.8 L/min) male aerator	13.95
060940SS	SS male std. 1.0 gpm (3.8 L/min)	45.85
060941A	Female std. 1.0 gpm (3.8 L/min)	13.25
060947A	3" hooded lever handle PR. H/C-TI w/ screws	42.20
060948A	4" blade handle PR. H/C-TI w/ screws	52.45
060949A	4" hooded lever handle PR. H/C-TI w/ screws	44.50
060950A	1.75 gpm flow regulator (10/pkg.)	15.80
060951A	Allen wrench for DEFM-100	13.90
060952A	Adaptor kit for DEFM-100	41.70
060953SS	SS spout assembly for 591T	543.75
060955A	2nd gen. driver board	171.75
060956A	Extension cord	33.45
060958A	Plug-in transformer for DEMD	44.05
060959A	Battery box (6 x 1.5AA) for DEMD	83.30
060960A	Aerator pkg. 0.5 gpm for DEMD	36.65
060960ANS	Outlet pkg. 0.5 gpm spray nickel stainless finish	39.40
060961A	Aerator pkg. 1 gpm for DEMD	36.65
060961ANS	Outlet pkg. 1 gpm spray nickel stainless finish	39.40
060962A	Escutcheon kit for DEMD	42.00
060963A	Holddown pkg. for DEMD	33.25
060964A	10mm to 3/8" compression kit w/ filter	52.15
060965A	Sensor kit for DEMD	334.30
060966A	Solenoid valve kit for DEMD	127.85
060967A	Remote control for DEMD	237.55
060968A	Extension cable for DEMD	43.40
060971A	1.75 gpm insert kit for cast shower head	22.20
060972A	Filter screen (6/pkg.) for Sloan/Zurn tails	38.25
060973A	1.5 gpm outlet for 22C w/ wrench flats	18.45
060973SS	SS 1.5 gpm outlet for 22C w/ wrench flats	22.30
060974A	Hardwire converter (DEMD Series) 24VAC to 9DC	62.90
060975A	Escutcheon for PB diverter shower	46.65
060983A	Driver board for 860T Series	189.20
060984A	Push button extension cord for 860T Series	28.10
060985A	10" SS cover & screws for 860T #3 control box	158.85
060986A	4" SS cover & screws for 860T #6 control box	91.20
060987A	12" SS cover & screws for 860T #7 control box	212.40
060988A	12" SS cover & screws for 860T #8 control box	212.40
060989A	3000T 3rd Gen Controller	549.00
060991A	30 deg. Inst. shower head 1.75 gpm	181.80
061006A	Rigid swivel gooseneck w/ aerator adaptor	58.65
061007A	Rigid swivel gooseneck w/ aerator adaptor	83.30
061010A	1.5 gpm insert kit for cast shower head	22.20
061011A	30 deg inst shower head - 1.5 gpm	190.95
061012A	Solenoid assembly (DEMD-800)	127.85

Model	Description	Price
061013A	Holddown package (DEMD-800)	57.80
061014A	Adapter kit (DEMD-800)	8.95
061018A	TECK I parts kit	29.65
061019A	Cast cap assembly	65.45
061022A	Electronic FV cap assembly	177.50
061023A	TECK I & II cover cap & reg. screw	79.15
061024A	TECK II reg screw & "O" ring assembly	14.90
061025A	Univ TV parts repair kit	55.15
061030A	Sensor for 2nd gen. 591T Series	132.35
061031A	Gasket for 591T (3/pkg.)	34.85
061032A	860T upgrade kit for old 1000T10x3 (8 x 8)	627.40
061033A	860T upgrade kit for old 1000T10x6 (4 x 4)	602.80
061034A	860T upgrade kit for old 1000T10x7 (12 x 12)	656.60
061035A	Set screw for HDF elbow handle	3.20
061036A	Gasket for 500-HDF Series	4.50
061037A	0.5 gpm outlet - 500-HDF Series	13.55
061038A	Aerator key for 500-HDF Series	2.05
061039A	Solenoid valve kit for DEMD WM	134.30
061041A	Sensor kit for DEMD WM	286.05
061042A	Holddown package for DEMD WM	67.95
061043A	Escutcheon kit for DEMD WM	8.75
061044A	Adapter pkg. for DEMD WM	45.00
061045A	Conduit for DEMD WM	28.00
061046A	Battery box for DEMD WM	79.35
061047A	Hardwire converter w/ battery backup	108.25
061050A	Escutcheon	47.75
061051A	T13H handle kit for shower valve	35.85
061052A	Set screw & button	7.10
061053A	Thermostatic escutcheon	51.15
061054A	Temperature knob, cover & screw	50.00
061055A	Diverter handle, screw & button	51.40
061058A	Diverter valve	218.70
061063A	Replaceable lens	12.40
061065A	CP metal cover w/ screws	48.45
061069A	Hardwire converter & rigid connection assembly	76.20
061069A-BB	HW converter w/ rigid connector	133.75
061071A	Pkg. of 2 - holddown adapter	10.70
061104A	0.35 gpm (1.32 L/min.) V.R. outlet Male	25.30
061104SS	0.35 gpm (1.32 L/min.) V.R. SS outlet Male	46.85
061105A	0.35 gpm (1.32 L/min.) V.R. outlet Female	29.80
061106A	0.35 gpm (1.32 L/min.) standard outlet Male	13.95
061107A	0.35 gpm (1.32 L/min.) standard outlet Female	13.95
061110A	0.5 outlet for 100HDF-DST series	23.60
061118A	Careguard 1.5 gpm laminar male	28.75
061118ANS	Outlet pkg. 1.5 gpm laminar nickel stainless finish	32.15
061119A	8" Proximity plate	98.50
061124A	Washer package (6/pkg.)	5.10
061125A	2.5 gpm inst. cast shower head	178.60
061127A	2 lever handles w/ 2 screws, red and blue index buttons	27.65
061128A	2 ceramic cartridges, hot and cold	45.35
061131A	Extension kit for 060852A diverter valve	16.40
061132A	WC E-FV kit (includes e-board & button)	237.80
061134A	Thermostatic mixing valve (for #8 box)	214.35
061135A	Gasket retrofit kit for 061134A (3/pkg.)	6.80
061136A	Check valves for R2570-MIX (Pkg. of 2)	14.55
061137A	Wrench for 061134A & R2570-MIX	4.50
061138A	Cover screws for 3rd gen. E-FV (2011)	5.65
061139A	CP metal cover for 3rd gen. E-FV (2011)	50.15

DELTA COMMERCIAL TECHNICAL SERVICE 1-877-509-2680
ONLINE CATALOGS: www.deltacommercialfaucets.com (Core products ONLY)
www.specselect.com (Complete Product Offering & Part Numbering System)

Model	Description	Price
061140A	Case top for 3rd gen. E-FV (2011)	8.50
061141A	Cover gasket (3/pkg.) for 3rd gen. E-FV (2011)	18.00
061142A	W.C. repair kit for 3rd gen. E-FV (2011)	406.40
061143A	UR repair kit for 3rd gen. E-FV (2011)	406.40
061144A	WC w/ dual flush repair kit for 3rd gen. E-FV (2011)	406.40
061149A	DEMD-86000 sensor kit	320.00
061150A	DEMD-86000 seals and screw kit	18.65
061151A	DEMD-86000 diaphragm	11.30
061152A	DEMD-86000 outlet tube	23.85
061156A	4" E-Lav spout gasket	51.90
061157A	Spacer pkg. for high rise Prox	19.65
061158A	Spacer pkg. for 4" CS Prox	45.50
061159A	4" Deck plate and holddown pkg. (additional deck thick)	94.00
061160A	8" Deck plate and holddown pkg. (additional deck thick)	125.90
061161A	WC E-FV kit (includes E-board & button) w/hard connector	237.80
061162A	UR E-FV kit (includes E-board & button) w/hard connector	237.80
061163A	Lock down kit DEMD-201/211	31.55
061164A	Sensor DEMD-201/211	319.95
061165A	Sensor DEMD-101/111	319.95
061166A	Solenoid valve kit DEMD-101/11 1/201/211	136.10
061167A	Adapter for vacuum breaker tube DEMD-86000	76.90
061168A	DEMD 101/111 hardwire converter	24.55
061169A	Cast cap/solenoid and regulating screw assembly	312.75
061170A	Plastic case for 3rd gen. E-FV (2011)	10.65
061171A	Tubular spout for 28P44	27.00
061172A	Gooseneck spout for 28P49	33.20
061173A	Angular spout for 28P42	37.00
061175A	HDF Proximity spacer package	19.20
061176A	VR Male 1.5 gpm laminar outlet	28.75
061177A	VR Female 1.5 gpm laminar outlet	28.75
061178A	1.5 gpm laminar swivel outlet for DEMD	26.35
061185A	VR male stream straightener outlet (590T/591T)	13.00
061186A	VR female stream straightener outlet (1500T/3000T)	13.00
061187A	Male stream straightener outlet (600T)	13.00
061191A	Elbow & tee for R3070-MIXTLF	47.30
061196A	Volume control handle assembly for T17TH	79.20
061198A	590TP Spout Gasket	15.35
061199A	Spout and outlet pkg. 0.5 gpm	110.30
061199ANS	Spout and outlet pkg. 0.5 gpm	121.50
061200A	Spout and outlet pkg. 1.0 gpm	110.30
061200ANS	Spout and outlet pkg. 1.0 gpm	121.50
061201A	4 x 4 x 4 Box w/ bushing & guard	108.35
061202A	Spout and outlet pkg. 1.5 gpm	114.10
061202ANS	Spout and outlet pkg. 1.5 gpm	121.50
061203A	Vandal resistant male 0.5 gpm laminar outlet	26.35
061203SS	Vandal resistant male 0.5 gpm laminar SS outlet	35.55
061204A	Vandal resistant female 0.5 gpm laminar outlet	26.35
061206A	Proximity Clip-On Sensor Module	116.85
061209A	Wallmount sensor trim kit (red)	660.80
061210A	Wallmount sensor trim kit (blue)	660.80
061213A	WC retrofit complete (incl. cover, cap, diaphragm/guide and pin)	174.50
061214A	UR retrofit complete (incl. cover, cap, diaphragm/guide and pin)	174.50
061215A	Non hold open retrofit kit	89.50
061216A	WC diaphragm/guide	29.05
061217A	UR diaphragm / guide	29.05
061218A	Dual flush sub-assembly	534.60
061221A	2.2 gpm laminar outlet for DEMD-400 Series	27.80
061222A	Non hold open conc retrofit kit WC	79.35

Model	Description	Price
061223A	Non hold open conc retrofit kit UR	79.35
061226A	Handshower w/ PB, white 2.5 gpm	34.60
061227A	4" x 4" SS cover for 81T WMs	141.45
061228A	Retrofit kit BT E-FV WC 2nd gen to 3rd gen w/s&g	393.00
061229A	Retrofit kit BT E-FV UR 2nd gen to 3rd gen w/s&g	393.00
061230A	Retrofit kit HW E-FV WC 2nd gen to 3rd gen w/s&g	585.60
061231A	Retrofit kit HW E-FV UR 2nd gen to 3rd gen w/s&g	585.60
061232A	E-board for .5L 1600T & WM models	278.85
061233A	Metering urinal cartridge	45.90
061234A	Bedpan spray face assembly	12.00
061235A	Bedpan glide ring	22.95
061236A	Bedpan spindle nut assembly	33.70
061237A	Bedpan diverter assembly	488.55
061238A	83T cap assembly	93.75
061239A	Oscillating handle	19.85
061240A	Urinal metering cartridge kit	65.30
061241A	Urinal push button metering retrofit kit	101.25
061242A	Urinal push button and set screw kit	27.95
061243A	Tube and adaptor S/A	158.80
061244A	4" x 4" SS cover for 1600T6	140.55
061245A	Oscillating handle metering retrofit kit	107.05
061246A	Oscillating handle and bonnet kit	30.20
061247A	Outlet tube w/ dual checks (for 86T5 & DEMD-86)	74.60
061248A	Dual check adaptor (for 1600T9)	102.75
061249A	VB adaptor assembly	78.05
061250A	VB assembly	114.75
061251A	Mounting box cover for DEMD WM (2013 on)	65.75
061252A	Dual Driver Board H2Optics and Proximity	162.85
061253A	M4 4" x 5" set screw (12/pkg.) w/ allen wrench for DEMD-402	7.55
061254A	Outlet nipple assembly w/ 3/8" compression	96.80
061255A	Battery holder - square 4-AA version	13.65
061256A	36" extension cable (H2Optics/Proximity combo board)	46.90
061258A	Holddown pkg	35.10
061259A	Proximity Dual Board Grounding Wire	36.50
061260A	Push button cage assembly for ADA 83T	72.00
061263A	Anchor plate screw (12/pkg.)	4.55
061264A	Spout plate 4" x 4"	128.25
061265A	14" x 20" plate w/ push button hole only	307.10
061266A	Pkg. of 3 - 0.5 gpm laminar outlet	81.65
061267A	Pkg. of 3 - 1.0 gpm laminar outlet	81.65
061268A	Pkg. of 3 - 1.5 gpm laminar outlet	81.65
061269A	4" plate assembly - chrome	64.30
061269SS	4" plate assembly - SS	77.15
061270A	8" plate assembly - chrome	112.50
061270SS	8" plate assembly - SS	133.90
061271A	Proximity Conversion Kit	318.20
061272A	Sensor module for WC - WMs & 1600T	288.35
061273A	Sensor module for UR - WMs & 1600T	288.35
061275A	Chrome cover, screws & bit	103.70
061277A	2.5 gpm insert kit	22.20
061278A	2.0 gpm Insert Kit for Cast Showerhead w/ Flow Control & Sprayplate	22.20
061280A	UR retrofit kit for WM FVs	569.45
061281A	WC retrofit kit for WM FVs	569.45
061282A	UR retrofit kit for WM FVs	612.45
061283A	WC retrofit kit for WM FVs	612.45
061284A	UR retrofit kit for 1600T6 FVs	465.80
061285A	WC retrofit kit for 1600T6 FVs	465.80

Model	Description	Price
061286A	UR retrofit kit for 1600T6 FVs	508.80
061287A	WC retrofit kit for 1600T6 FVs	508.80
061288A	Pkg. of 6 - fibre washers	7.55
061289A	DEMD-112LF - cover and screw	30.75
061290A	DEMD-212LF - cover and screw	21.20
061291A	DEMD-312LF - cover and screw	21.20
061292A	3000T Adapter Cable	30.90
061293A	Spacer pkg. for Proximity	34.30
061294A	Single hole deck gasket	54.55
061295A	Nut & washer for Proximity	13.80
061296A	Pkg. of 3 - 2.2 gpm laminar outlets	81.45
061297A	590-HDF 3rd Gen Driver Board	168.30
061298A	590-HDF 3rd Gen Extension Cable	32.90
061299A	HW to BT conversion kit for 1600T & WMs	48.25
061300A	Pkg. of 6 - hose washers	7.05
061301A	Flush Valve Stop with Cap	112.00
062001A	Proximity thin tab	20.00
062004A	Spacer for 600T Proximity	12.50
062005A	Spacer for Grail Proximity	12.00
062007A	Brass seat	14.05
062021A	4" plate 600T Proximity	20.05
062021SS	4" cover plate w/ SS finish	76.75
062022A	4" cover plate for Grail Proximity	20.05
062023A	Recessed box connection kit w/hose and flange	28.95
062025A	Washer for 3rd gen. WC (3/pkg.)	14.50
062027A	Cage repair kit	5.70
062029A	Prox. ground wire kit	8.65
062032A	3/8" x 3/8" compression polymer hose	16.80
063000A	RH CER-TECK® cartridge	21.35
063001A	LH CER-TECK® cartridge	21.35
063002A	Structure repair kit	35.15
063005A	R.H. TECK® structure kit	25.70
063006A	L.H. TECK® structure kit	25.70
063007A	WM gooseneck spout	181.95
063008A	DM cast spout	122.45
063013A	Renewable seats (12/pkg.)	20.30
063014A	CP cast DM spout	170.95
063015A	Spout base only for DJ spout	116.65
063019A	Pre-rinse retrofit kit	495.20
063020A	Deckmount gooseneck assembly	112.50
063024A	Tee assembly	20.90
063027A	Cast spout w/ hole	128.75
063028A	Cast spout l/ hole	127.90
063029A	Center body - 10-1/2" long	69.00
063031A	Center diverter body	91.75
063032A	Center body - 6-1/2" long	33.75
063033A	Spout adapter & fibre gasket	29.80
063034A	Shank & washer kit	29.90
063035A	Swing spout adapter & fibre gasket	26.20
063036A	Center body for third valve connection	102.35
063041A	Long renewable seat	3.95
063044A	8" wallform swing spout	56.65
063046A	Hose end adapter	13.25
063049A	Escutcheon & fiber washer	32.90
063050A	Rigid/swivel adaptor & "O" ring	30.60
063054A	CER-TECK® retrofit pkg.	35.85
063055A	Gooseneck spout adapter and gasket	24.75
063056A	Swing spout adapter and gasket	24.75

Model	Description	Price
063057A	C Series widespread renewable seat	16.80
063063A	Limited swing gooseneck	73.75
063064A	Limited swing gooseneck	114.15
063065A	Limited swing gooseneck	79.35
063066A	Limited swing gooseneck	85.90
063067A	Limited swing gooseneck	86.45
063068A	Limited swing gooseneck	100.05
063069A	Limited swing gooseneck	113.40
063070A	Limited swing gooseneck	79.85
063071A	Limited swing gooseneck	120.30
063072A	Limited swing gooseneck	85.35
063073A	Limited swing gooseneck	92.00
063074A	Limited swing gooseneck	92.70
063075A	Limited swing gooseneck	105.65
063076A	Limited swing gooseneck	119.50
063077A	Limited swing gooseneck	85.35
063083A	Limited swing gooseneck	47.65
063084A	Gooseneck spout adapter pkg.	22.80
063085A	Gooseneck spout adapter pkg.	27.30
063086A	CP swing spout adapter	46.10
063087A	Gooseneck spout	51.15
063088A	Gooseneck spout	55.80
063089A	Gooseneck spout	59.85
063090A	Gooseneck spout	59.85
063091A	Gooseneck spout	66.30
063092A	Gooseneck spout	72.00
063093A	Gooseneck spout	74.10
063094A	Gooseneck spout	76.35
063101A	RHCP brass TUF-TECK® structure kit	22.95
063102A	LHCP brass TUF-TECK® structure kit	22.95
063103A	Deckmount gooseneck spout	109.10
063104A	Nipple	10.50
063105A	Offset shank & rubber washer	124.35
063106A	Check structure, gasket & cap	166.05
063107A	3" hooded lever handle, CER-TECK®	62.35
063108A	4" blade handle w/ sani guards, CER-TECK®	87.20
063116A	CP adapter	7.40
063120A	Escutcheon & fiber washer swing spout inline	63.05
063121A	Retrofit pkg. 4" hooded lever CER-TECK®	66.80
063124A	Aerator adapter	8.35
063125A	Single post cast Proximity	324.35
063126A	4" cast Proximity	409.00
063127A	Brass solenoid	124.10
063128A	Boxes assembly w/ solenoid (less driver board & battery holder)	143.55
063129A	590 HDF Proximity Series spout assembly	233.90
063130A	Mixing Tee & Checks for 87T Series	76.75
063131A	3/8" female iron pipe x 3/8" compression connector, nut and ferrule	5.30
063132A	590T spout assembly	337.45
063133A	591T spout assembly	449.95
063135A	Screwdriver stop repair kit	10.15
063136A	Thermostatic mixing valve 3/8"	146.85
063137A	Single hole turret gn spout assembly (R5 - aerator thread)	310.45
063138A	Single hole turret gn spout assembly (R5 - smooth end)	303.00
063139A	Adapter w/ flow control (0.5 gpm)	14.00
063140A	Adapter w/ flow control (1.5 gpm)	13.50
063141A	590 HDF H2Optics® spout assembly	233.90
063142A	Single hole mount turret assembly smooth end (R3)	318.05
063143A	Single hole mount turret assembly smooth end (R4)	318.05

DELTA COMMERCIAL TECHNICAL SERVICE 1-877-509-2680
ONLINE CATALOGS: www.deltacommercialfaucets.com (Core products ONLY)
www.specselect.com (Complete Product Offering & Part Numbering System)

Model	Description	Price
063145A	Single hole mount turret assembly smooth end (R35)	318.05
063147A	Single hole mount turret assembly thread end (R4)	310.45
063159A	Single hole WM turret assembly thread end (R35)	295.65
063160A	Thin mount kit (3/8" elbow, nut, washer & gasket)	8.80
063161A	Thick mount kit (nut, washer, gasket, shank, 1/4" NPT pipe)	23.90
063162A	1.5 gpm adapter w/ flow control	44.00
063163A	1.5 gpm bushing w/ flow control	15.15
063164A	Check Valves for R2570-MIXLF	10.95
063167A	Single hole mount turret assembly smooth end (R5)	
	0.5.gpm 337.70	358.90
063170A	600T spout	229.50
063170SS	600T SS Spout	242.30
063171A	Check tail assembly	41.45
063172A	Spring retainer	59.80
063173A	Hose assembly & insulated grip	129.05
063174A	Spray head & hold open ring	140.00
063175A	Spray valve repair kit	58.75
063176A	1/2" angle stop	176.75
063177A	Lockshield structure assembly	34.15
063178A	Foot pedal cartridge	80.95
063179A	Thermo mixing valve w/gaskets	266.25
063180A	10 mm to 3/8" compression kit	50.40
063181A	Single hole mount turret assembly	342.80
063182A	Single hole mount turret assembly	342.80
063183A	Single hole mount turret assembly	342.80
063184A	Single hole mount turret assembly	342.80
063185A	Single hole mount turret assembly	342.80
063186A	Single hole mount turret assembly	342.80
063187A	Single hole mount turret assembly	342.80
063188A	Single hole mount turret assembly	342.80
063189A	Single hole mount turret assembly	342.80
063190A	Single hole mount turret assembly	342.80
063191A	Single hole mount turret assembly	342.80
063192A	Single hole mount turret assembly	342.80
063193A	Single hole mount turret assembly	337.45
063194A	Single hole mount turret assembly	342.80
063195A	Single hole mount turret assembly	342.80
063196A	VR 1.5 gpm WM showerhead complete	190.95
063199A	Sleeve for 24T	36.35
063200A	Single hole mount turret assembly	342.80
063201A	Single hole mount turret assembly	342.80
063202A	Single hole mount turret assembly	342.80
063203A	Single hole mount turret assembly	342.80
063204A	Single hole mount turret assembly	342.80
063205A	Single hole mount turret assembly	342.80
063206A	Single hole mount turret assembly	342.80
063207A	Single hole mount turret assembly	342.80
063208A	Single hole mount turret assembly	342.80
063209A	Single hole mount turret assembly	342.80
063210A	590T spout assembly	358.90
063211A	591T spout assembly	358.90
063213A	VR 1.75 gpm WM showerhead complete	190.95
063214A	VR 2.0 gpm WM showerhead complete	190.95
063215A	Anchor plate & ss screw	33.80
063216A	Hold down screw w/ "o" ring (12/pkg.)	63.05
063217A	Anchor plate "o" ring 12/pkg	27.05
063218A	Slip on spout inner "o" ring (12/pkg.)	6.80
063219A	Slip on spout complete 1.5 gpm	202.50

Model	Description	Price
063220A	Slip on spout rough in box	56.25
063221A	2.2 gpm male laminar w/ wrench flats for Grai®	39.55
063222A	Proximity gooseneck spout assembly	196.55
063222SS	Proximity gooseneck spout assembly	230.90
063223A	Pkg. of 2 - coupling nuts	7.05
063226A	Proximity gooseneck spout assembly	209.65
063226SS	Proximity gooseneck spout assembly	230.85
063227A	Proximity gooseneck spout assembly	196.55
063227SS	Proximity gooseneck spout assembly	230.90
063229A	Proximity gooseneck spout assembly	196.55
063229SS	Proximity gooseneck spout assembly	230.90
063230A	590-HDF 3rd Gen Spout Assembly	229.25
063231A	1/2" sweat X 3/8" compression	27.10
063235A	2.2 gpm Smooth End Gooseneck/Sensor (R3) for 1500T3	342.80
063236A	2.2 gpm Smooth End Gooseneck/Sensor (R5) for 1500T3	342.80
063237A	2.2 gpm Smooth End Gooseneck/Sensor (R7) for 1500T3	342.80
063238A	2.2 gpm Smooth End Gooseneck/Sensor (R35) for 1500T3	342.80
063239A	2.2 gpm Smooth End Gooseneck/Sensor (R3) for 1500T4	342.80
063240A	2.2 gpm Smooth End Gooseneck/Sensor (R5) for 1500T4	342.80
063241A	2.2 gpm Smooth End Gooseneck/Sensor (R7) for 1500T4	342.80
063242A	2.2 gpm Smooth End Gooseneck/Sensor (R35) for 1500T4	342.80
063243A	2.2 gpm Smooth End Adapter & Flow Control for 1500T4	
	Boxes 1 & 8	15.15
063244A	2.2 gpm Smooth End Adapter & Flow Control for 1500T4 Box 0	44.00
063245A	2.2 gpm Smooth End Adapter & Flow Control for 1500T3	15.00
068030A	Pol DW valve handle	5.70
068032A	Tail	9.15
068040A	CP filter pump S/A	69.65
068041A	CP (ball valve) nozzle	13.80
068042A	Bagged locknut & washer	6.20
068046A	Adapter, tube inlet	25.00
068047A	Tail & locknut pkg.	14.90
068048A	Insert (3/pkg.)	37.75
068049A	CP FE nozzle	9.80
068051A	Helium index button	8.25
068052A	Propane index button	8.25
068053A	Carbon Dioxide index button	8.25
068056A	Repair DW stem & dphgm	17.00
068057A	(CW) Cold water index button (3/pkg.)	13.25
068058A	(NIT) Nitrogen index button (3/pkg.)	13.25
068059A	(OXY) Oxygen index button (3/pkg.)	13.25
068061A	(VAC) Vacuum index button (3/pkg.)	13.25
068062A	(HW) Hot water index button (3/pkg.)	13.25
068063A	(DW) Distilled water index button (3/pkg.)	13.25
068064A	(EF) Eau froid index button (3/pkg.)	13.25
068065A	(EC) Eau chaud index button (3/pkg.)	13.25
068067A	(GAZ) Gaz index button (3/pkg.)	13.25
068070A	(VIDE) Vide index button (3/pkg.)	13.25
068072A	(AIR) Air index button (3/pkg.)	13.25
068074A	(GAS) Gas index button (3/pkg.)	13.25
068075A	(H) Hydrogen index button (3/pkg.)	13.25
068077A	3/8" IP shank 4.44 L tail	26.50
068078A	3/8" IP shank 3.25 L	23.10
068079A	3/8" IP shank 2.38 L tail	18.00
068083A	Coupling nut	9.55
068086A	CP plain button	17.65
068087A	1/2" FIP x 3/4" MIP adapter	8.85
068089A	Str FE nozzle S/A	31.00

Model	Description	Price
068090A	CP filter pump & diff S/A	104.80
068092A	3/8" cplg. nut & 1/4" tail conn. pkg.	16.00
068093A	1/2" cplg. nut & 1/4" tail conn. pkg.	10.15
068099A	SS needle structure & seat (NON-GAS)	43.55
068105A	Holddown nut kit	2.10
068106A	Repair DW stem kit	44.95
068128A	W6629 repair kit	73.45
H78	LG blade handle w/ screw-moni	30.00
RP11768HDF	Brass lever handles w/ screws	60.30
RP12491	Handles - wrist blade - w/ screws	70.45
RP21630	Escutcheon for HDF single handle pressure balanced tub & shower - chrome	34.30
RP21874	Lever handle w/ set screw - chrome	23.35
RP30396	Handle limit stop	5.10
RP30522	Model 591 gasket	5.75
RP30523	Braided hose	18.15
RP30528	Cast cover plate	87.25
RP30532	Battery holder w/ label	13.40
RP31704	0.5 gpm V.R. spray outlet	24.10
RP31704SS	0.5 gpm V.R. spray outlet SS	75.90
RP31705	1.5 gpm V.R. spray outlet	23.00
RP32508	Hardwire transformer	42.80
RP32796	24" grab bar w/ adjustable slide	142.20
RP32797	36" grab bar w/ adjustable slide	153.85
RP32856	Plug-in transformer	42.80
RP34280	8" cover plate	117.00
RP34322	Single hole ceramic cartridge (for 22C)	28.30
RP34324	4" ceramic cartridge (for 22C)	28.30
RP34403	Handle w/ button and set screw (for 22C)	25.35
RP34403SS	SS handle w/ button & set screw	20.70
RP34404	Cap (for 22C)	5.40
RP34404SS	SS cap	10.00
RP34405	Single hole mounting hardware (for 22C)	9.40
RP36200	Handle - mixing	30.10
RP36201	E-flow stem assembly kit	24.60
RP36203	Extension nut/washer for electronic	12.20
RP42112	Gasket for 22C (4")	12.55
RP44398	Gray cam, w/ stops	5.15
RP5212	Delta handle	17.40
RP52834	HDF handle & set screw	30.25
RP5645	Delta elbow handle w/ set screw	28.25
RP64696	Spout assembly (for 710 Series)	124.55
RP64697	Spout assembly (711 Series)	124.55
RP64698	Locking Pin	6.05
RP72773	Valve assembly for slow close	54.60
W6850	Series (see Page C162)	
W6870	Base w/ locknut	21.20
W6873	Retort rod w/ base	98.30
W6878	Flow control aerator and spout end adapter, 3/8" F.I.P. inlet	16.25
W6890	Series (see Page C162)	
W6916	Adapter and flange, 3/8" N.P.T. female	26.30
W6968	3-arm black handle w/ screw	15.25
W6971	2-arm metal handle w/ screw	21.20
W6980	Compression structure (to 1977) less seat	21.20

Model	Description	Price
-------	-------------	-------

ALABAMA	IDAHO	MAINE	NEW HAMPSHIRE	RHODE ISLAND
Will & Pierce Agency 6612 Pine Hill Road Daphne, AL 36526 (251) 621-1550 Fax (251) 621-3036	<i>Southern Region</i> Mountain West Marketing 3147 North Highway 89 Pleasant View, UT 84404 (801) 782-0100 Fax (801) 782-2021	Futura Sales 861 Edgell Road Framingham, MA 01701 (508) 788-9257 Fax (508) 788-9258	Futura Sales 861 Edgell Road Framingham, MA 01701 (508) 788-9257 Fax (508) 788-9258	Futura Sales 861 Edgell Road Framingham, MA 01701 (508) 788-9257 Fax (508) 788-9258
ALASKA	ILLINOIS	MARYLAND	NEW JERSEY	SOUTH CAROLINA
Almex Alaska, LLC 5401 Cordova St. Suite 302 Anchorage, AK 99518 (907) 346-4669 Fax (907) 346-4675	<i>Northern Region</i> Synergy Sales NW, LLC 12835 Bel-Red Road, Suite 100 Bellevue, WA 98005 (425) 502-7944 Fax (425) 502-9026	Barger and Associates 101 Production Dr., Suite 104 Yorktown, VA 23693 (757) 873-4574 Fax (757) 873-9530	<i>Northern Region</i> Altherm, Inc. 255 Humphrey Street Englewood, NJ 07631 (201) 871-0500 Fax (201) 871-0314	Smith & Stevenson Co., Inc. P.O. Box 240009 Charlotte, NC 28224 (704) 525-3388 Fax (704) 527-0539
ARIZONA	INDIANIA	MASSACHUSETTS	NEW MEXICO	SOUTH DAKOTA
Bobier Sales, Inc. 3626 E. Southern, Suite 3 Phoenix, AZ 85040 (602) 304-0001 Fax (602) 304-0005	<i>Northern Region</i> Added Sales Co. 795 Mittel Drive Wood Dale, IL 60191 (630) 694-1300 Fax (630) 694-9148	Futura Sales 861 Edgell Road Framingham, MA 01701 (508) 788-9257 Fax (508) 788-9258	<i>Southern Region</i> Rich Tomkins Company, Inc. 235 Bridgewater Road Ashton, PA 19014 (610) 859-3552 Fax (610) 859-6080	<i>Western Region</i> Rocky Mountain Sales, LLC 6765 Franklin Street Denver, CO 80229-7111 (303) 289-4191a Fax (303) 286-9069
ARKANSAS	MINNESOTA	MICHIGAN	NORTH CAROLINA	TENNESSEE
Rich Sales, Inc. P.O. Box 241010 Little Rock, AR 72223 (501) 868-9711 Fax (501) 868-9787	Summit Sales, Inc. 1803 E. 123rd Terrace Olathe, KS 66061 (913) 791-9599 Fax (913) 791-9598	Burke Agency Inc. 2605-A Oakley Park Road Walled Lake, MI 48390 (248) 669-2800 Fax (248) 669-3310	Smith & Stevenson Co., Inc. P.O. Box 240009 Charlotte, NC 28224 (704) 525-3388 Fax (704) 527-0539	<i>Central/Eastern Region</i> NCS Corp. 7440 W. 78th Street Bloomington, MN 55439 (952) 941-4464 Fax (952) 941-0396
CALIFORNIA	MISSISSIPPI	MISSOURI	NORTH DAKOTA	TEXAS
Mega Western Sales 16200 S. Maple Ave. Gardena, CA 90247 (310) 323-7900 Fax (310) 323-9421	Woolf-Harris, Inc. 210 General Patton Avenue Mandeville, LA 70471 (504) 733-8733 Fax (504) 733-4980	NCS Corp. 7440 W. 78th Street Bloomington, MN 55439 (952) 941-4464 Fax (952) 941-0396	NCS Corp. 7440 W. 78th Street Bloomington, MN 55439 (952) 941-4464 Fax (952) 941-0396	Southwest Sales—North 615 E. Highway 121, Suite 300 Coppell, TX 75019 (972) 881-8757 Fax (972) 881-2115
COLORADO	MONTANA	NEBRASKA	OHIO	UTAH
Rocky Mountain Sales, LLC 665 Franklin Street Denver, CO 80229-7111 (303) 289-4191 Fax (303) 286-9069	Rocky Mountain Sales, LLC 6765 Franklin Street Denver, CO 80229-7111 (303) 289-4191 Fax (303) 286-9069	<i>Western Region</i> Rocky Mountain Sales, LLC 6765 Franklin Street Denver, CO 80229-7111 (303) 289-4191 Fax (303) 286-9069	Libb Company, Inc. 7860 N. Central Dr. Lewis Center, OH 43035 (740) 549-1516 Fax (740) 548-0985	Mountain West Marketing 3147 North Highway 89 Pleasant View, UT 84404 (801) 782-0100 Fax (801) 782-2021
CONNECTICUT	NEVADA	NEBRASKA	OREGON	VERMONT
Futura Sales 861 Edgell Road Framingham, MA 01701 (508) 788-9257 Fax (508) 788-9258	Mega Western Sales 16200 S. Maple Ave. Gardena, CA 90247 (310) 323-7900 Fax (310) 323-9421	<i>Western Region</i> Rocky Mountain Sales, LLC 6765 Franklin Street Denver, CO 80229-7111 (303) 289-4191 Fax (303) 286-9069	Synergy Sales NW, LLC 12835 Bel-Red Road, Suite 100 Bellevue, WA 98005 (425) 502-7944 Fax (425) 502-9026	Futura Sales 861 Edgell Road Framingham, MA 01701 (508) 788-9257 Fax (508) 788-9258
DELAWARE	PENNSYLVANIA	NEBRASKA	PENNSYLVANIA	VIRGINIA
Sussex County Barger and Associates 101 Production Dr., Suite 104 Yorktown, VA 23693 (757) 873-4574 Fax (757) 873-9530	<i>Eastern Region</i> Rich Tomkins Company, Inc. 235 Bridgewater Road Ashton, PA 19014 (610) 859-3552 Fax (610) 859-6080	<i>Western Region</i> Rocky Mountain Sales, LLC 6765 Franklin Street Denver, CO 80229-7111 (303) 289-4191 Fax (303) 286-9069	<i>Eastern Region</i> Rich Tomkins Company, Inc. 235 Bridgewater Road Ashton, PA 19014 (610) 859-3552 Fax (610) 859-6080	Barger & Associates 101 Production Dr., Suite 104 Yorktown, VA 23693 (757) 873-4574 Fax (757) 873-9530
DISTRICT OF COLUMBIA	RHODE ISLAND	NEW HAMPSHIRE	RHODE ISLAND	WEST VIRGINIA
Barger and Associates 101 Production Dr., Suite 104 Yorktown, VA 23693 (757) 873-4574 Fax (757) 873-9530	<i>Northern/Central Region</i> Battersby/Danielson Assoc. 17740 Commerce Dr. Westfield, IN 46074 (317) 867-3799 Fax (317) 867-3499	Futura Sales 861 Edgell Road Framingham, MA 01701 (508) 788-9257 Fax (508) 788-9258	Futura Sales 861 Edgell Road Framingham, MA 01701 (508) 788-9257 Fax (508) 788-9258	<i>Northeastern Region</i> Barger and Associates 101 Production Dr., Suite 104 Yorktown, VA 23693 (757) 873-4574 Fax (757) 873-9530
FLORIDA	TEXAS	NEW HAMPSHIRE	NEW HAMPSHIRE	WEST VIRGINIA
Suncoast Sales, LLC 6306 Benjamin Rd., Suite 614 Tampa, FL 33634 (813) 901-8552 Fax (813) 901-8555	Counties of El Paso, Culberson, Reeves, Hudspeth, Jeff Davis, Pecos, Brewster, Terrell & Presidio W W Sales Company 3500 Richmond Dr., N.E. Suite A Albuquerque, NM 87107 (505) 878-0636 Fax (505) 878-0638	Futura Sales 861 Edgell Road Framingham, MA 01701 (508) 788-9257 Fax (508) 788-9258	Futura Sales 861 Edgell Road Framingham, MA 01701 (508) 788-9257 Fax (508) 788-9258	<i>Northeastern Region</i> Barger and Associates 101 Production Dr., Suite 104 Yorktown, VA 23693 (757) 873-4574 Fax (757) 873-9530
GEORGIA	UTAH	NEW HAMPSHIRE	NEW HAMPSHIRE	WEST VIRGINIA
Pulley & Associates 430 Lovena Drive S.E., Ste.200 Marietta, GA 30067 (770) 425-0706 Fax (770) 428-3934	Mountain West Marketing 3147 North Highway 89 Pleasant View, UT 84404 (801) 782-0100 Fax (801) 782-2021	Futura Sales 861 Edgell Road Framingham, MA 01701 (508) 788-9257 Fax (508) 788-9258	Futura Sales 861 Edgell Road Framingham, MA 01701 (508) 788-9257 Fax (508) 788-9258	<i>Northeastern Region</i> Barger and Associates 101 Production Dr., Suite 104 Yorktown, VA 23693 (757) 873-4574 Fax (757) 873-9530
HAWAII	VERMONT	NEW HAMPSHIRE	NEW HAMPSHIRE	WEST VIRGINIA
J & B Marketing 171-D Hamakua Drive Kailua, HI 96734 (808) 263-7480 Fax (808) 263-7490	Futura Sales 861 Edgell Road Framingham, MA 01701 (508) 788-9257 Fax (508) 788-9258	Futura Sales 861 Edgell Road Framingham, MA 01701 (508) 788-9257 Fax (508) 788-9258	Futura Sales 861 Edgell Road Framingham, MA 01701 (508) 788-9257 Fax (508) 788-9258	<i>Northeastern Region</i> Barger and Associates 101 Production Dr., Suite 104 Yorktown, VA 23693 (757) 873-4574 Fax (757) 873-9530

Delta Faucet Company has an office in virtually every major city in the United States. Delta® agencies are staffed nationwide with more than 400 highly experienced sales professionals who live and work in your market to meet your needs at a local level promptly and efficiently. Your local representative will assume responsibility for communication throughout the supply chain, becoming an extension of your business to troubleshoot and ease everyday tasks. Your agency is readily available to assist with customer service, stocked warranty and service parts, provision and training, literature and displays. This level of advanced service is brought to you only by Delta Faucet Company.

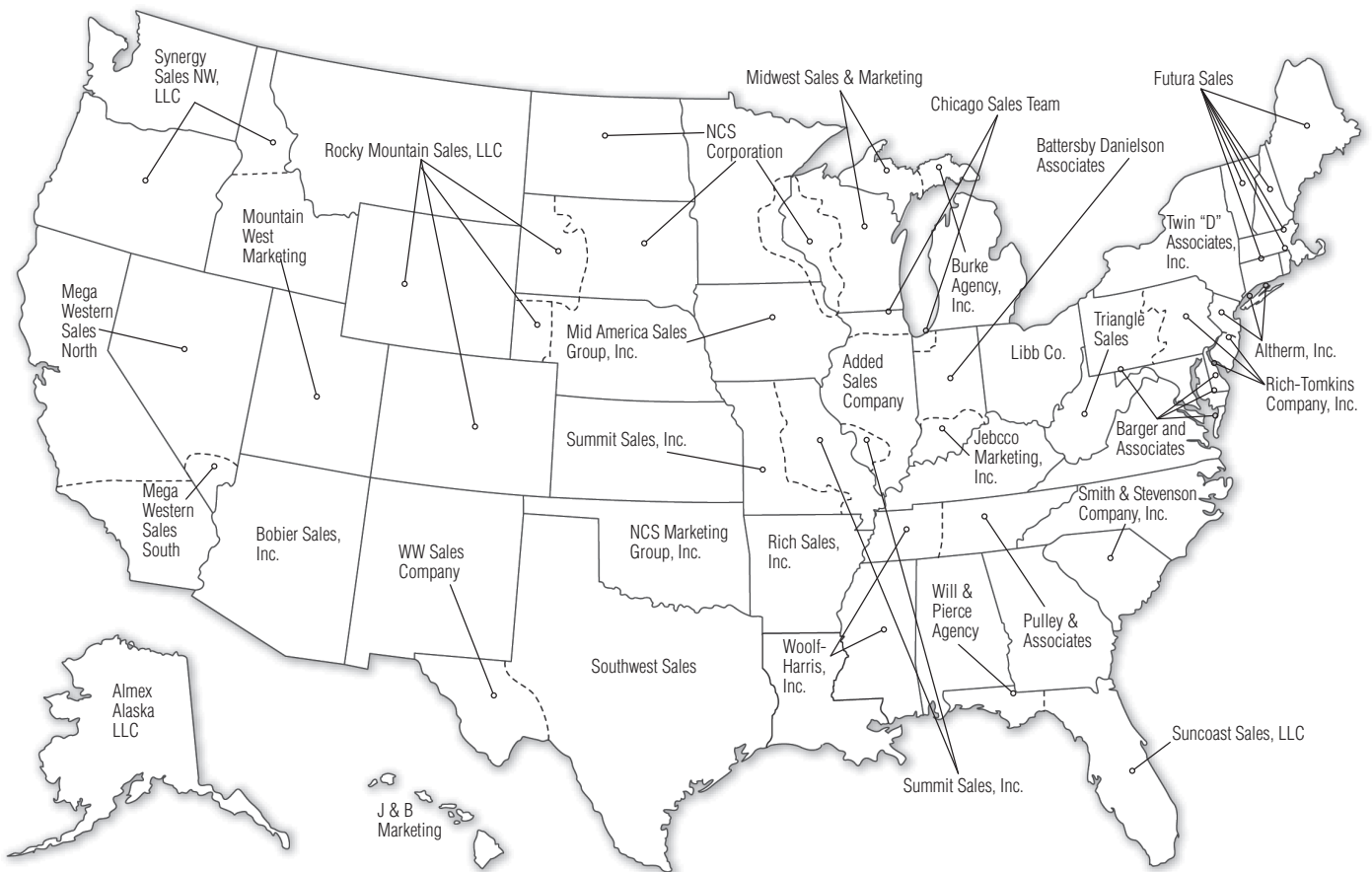

WARRANTY

These Delta® products are warranted to the original consumer purchaser or commercial user. Please refer to the “Limited Warranty” enclosed with each Delta product for specific details. Additional copies are available upon request.

RETURNED GOODS

Merchandise MAY NOT be returned for credit or replacement without prior inspection and written authorization from Delta Faucet Company (DFC). Any unauthorized return of products is expressly prohibited. A handling charge of 50% will be assessed against anyone attempting to return merchandise without prior authorization. Only product purchased directly from Delta Faucet Company by a wholesaler will be authorized for return. NO EXCEPTIONS.

WARRANTY RETURNS

A full wholesale price credit will be issued to authorized Delta Faucet wholesaler customers for returned merchandise that is defective as described in the warranty. The defective merchandise must be shipped freight prepaid by the least costly method of shipment and the freight cost of such shipment will be added to the price credit. If a replacement is made rather than a credit issued, Delta Faucet Company will ship the replacement freight prepaid. Product returned as defective that is found to be misused, abused, modified or otherwise NOT DEFECTIVE will receive credit at scrap value only.

OTHER RETURNS

All other returns will be handled in accordance with the then-current DFC Return Policy for Non-Defective Faucets, copies of which are available upon request.

PRICES

All prices and specifications of models are subject to change without notice. Orders will be invoiced at the prices prevailing at time of shipment.

NOTE

All orders are subject to all applicable DFC policies in effect at the time of order.

These Terms of Sale are subject to change without notice.

RETURN ADDRESS

All returns are to be sent to the following address:

Delta Faucet Company
3441 Ridgcrest Road Extended, Suite 12
Jackson, Tennessee 38305
Attn: Returned Goods Department

ActivTouch, Allora, Ara, Arctic, Arzo, Ashlyn, Brilliance, CER-TECK, Compel, Delta, DURAMOUNT, EZ Anchor, Foundations, Grail, HDF, H2Okinetic, H2Optics, InnoFlex, Innovations, In2ition, Jetted Shower XO, Lahara, Leland, MagnaTite, Monitor, MultiChoice, Orleans, Palo, Pilar, Proximity, Quick-Snap, Scald-Guard, Signature, SpecSelect, Teck, TempAssure, Temp2O, Tesla, Touch2O, Touch2O.xt, Touch-Clean, Trinsic, Tuf-Teck, Venetian Bronze, Vero, Victorian, Waterfall, and Windemere are registered trademarks of Masco Corporation of Indiana.

Addison, Cassidy, Champagne Bronze, Collins, Décor Assist, DIAMOND, Dryden, Essa, Fuse, Linden, Mateo, Multi-Flow, Odyssey, Talbott, TempSense, Tract-Pack, XO Jet Module, and Zura are trademarks of Masco Corporation of Indiana.

Explore even more innovation.

DELTA COMMERCIAL
see what Delta can do

Products Smart Solutions Support and Resources SpecSelect WHERE TO BUY search

Proximity[®] Sensing Technology

watch video learn more more smart solutions

Proximity[™] Sensing Technology is the next generation in responsive hands-free functionality. This revolutionary technology transforms the entire faucet into a sensor, automatically responding when approached.

SpecSelect[®] New Products Responsible. Resourceful.SM Project Categories

Home | Company | News | CEU Courses | Green at Delta | WaterSense | Project Categories | Case Studies | Contact Us | Masco Brands

Learn more about Electronic Lavatory Faucets with Proximity[®] Sensing Technology on page 5.

There's more to see on our websites:
deltacommercialfaucets.com and specselect.com

www.deltacommercialfaucets.com

- Featuring a detailed look at up to 200 of our core commercial products

www.specselect.com

- Featuring a detailed look at our complete 20,000 model commercial product offering
- Includes our unique dynamically created model-specific spec sheets for all models
- Includes our unique dynamic product selection guidance system, that ensures only valid product models can be selected

Everything you need to make your selection easier is right online at deltacommercialfaucets.com and specselect.com. If you have any additional questions, contact us at 800.345.DELTA.

Delta Commercial Technical Service
877.509.2680

DELTA COMMERCIAL **specselect**
see what Delta can do specselect.com

Catalog Index Parts Commercial Site Revit File Library search Advanced

Welcome to SpecSelect[®]

learn more more features

This state-of-the-art tool delivers exact, specific, and instantaneous information for sourcing commercial products. Explore over 40,000 models for all your project needs, whether renovating a healthcare facility, designing a hotel, or specifying a new college, you won't find a more comprehensive online catalogue than SpecSelect[®].

Catalog Index Parts Commercial Site

Site Requirements | Website Support | Quotation Edition | Favorites | Privacy Statement | About SpecSelect | Contact Us | Obsolete Index



see what Delta can do™

A MASCO COMPANY

Delta Faucet Company
55 E. 111th St., P.O. Box 40980
Indianapolis, IN 46280

Masco Canada Limited
350 S. Edgeware Rd.
St. Thomas, Ontario N5P 4L1

deltafaucet.com
800.345.DELTA (3358)

Delta Commercial Technical Service
877.509.2680

©2016 Delta Faucet Company
DL-1905 03/16